



**THE DATASHEET OF
C1206X7R100-475KNE**





FEATURES:

- Capacitance range: 0.1pF to 220uF
- Voltage range: 4V to 100V
- Terminations: 100% matte Tin (Sn), Palladium (Pd-Ag), Gold (Au) and Lead (Pb)
- Very low ESR in X7R/X7S/X6S/X5R (<10mΩ typical)
- Ceramic monolithic structure provides excellent reliability



PART NUMBER STRUCTURE

C	0805	COG	500	-	101	J	N	P	□ □															
Series	Size	Temperature Characteristic (Dielectric)	Rated Voltage		Capacitance	Tolerance	Termination	Packaging	Optional Thickness Identifier															
01005	0201	0402	0504	0603	0805	1206	1210	1812	2220	22212	COG	X7R	X7S	X6S	X5R	Y5V	Z5U	1st two digits are significant followed by number of zeroes.	4R0 = 4.0 VDCW 6R3 = 6.3 VDCW 100 = 10 VDCW 160 = 16 VDCW 250 = 25 VDCW 500 = 50 VDCW 630 = 63 VDCW 101 = 100 VDCW	1st two digits are significant, followed by number of zeroes. e.g: 101 = 100pF R denotes decimal 6R8 = 6.8pF	* B = ± 0.1pF * C = ± 0.25pF * D = ± 0.5pF F = ± 1% G = ± 2% J = ± 5% K = ± 10% M = ± 20% N = ± 30% Z = +80 - 20% * For values below 10pF only.	N = 100% matte Tin (Sn) over Nickel * P = Palladium Silver * G = Gold over Nickel Pb = 90% Tin (Sn) /10% Lead (Pb) * Pd/Ag & Gold terminations have limited values & sizes available.	D = Paper Tape (10" Reel) E = Embossed Tape (7" Reel) P = Paper Tape (7" Reel) R = Paper Tape (13" Reel) U = Embossed Tape (13" Reel)	Leave blank for standard thickness. Designate "-." for Min. "" for Max. followed by Thickness Code e.g: - E (min. thickness of .026") * E (max. thickness of .026")

Example P/N: C0805COG500-101JNP

Optional Thickness Identifier Codes:

CODE:	C	D	E	F	G	H	I	J	K	L	M	N	O	P	Q	R	S	T	U	V	6
DIMENSION:	.015	.020	.026	.030	.035	.040	.045	.050	.055	.060	.065	.070	.075	.080	.085	.090	.095	.100	.105	.110	.023

DIMENSIONS

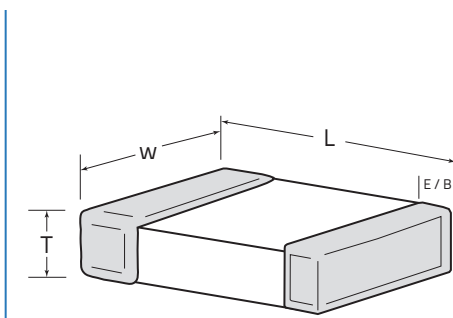

Unit: inches (mm)

SIZE	L	W	T	MIN. E/B
01005	0.016 ± 0.0008 (0.4 ± 0.02)	0.008 ± 0.0008 (0.2 ± 0.02)	See Specific Value	0.002 (0.05)
0201	0.024 ± 0.002 (0.6 ± 0.05)	0.012 ± 0.002 (0.3 ± 0.05)	See Specific Value	0.002 (0.05)
0402*	0.040 ± 0.002 (1.0 ± 0.05)	0.020 ± 0.002 (0.5 ± 0.05)	See Specific Value	0.004 (0.10)
0603	0.063 ± 0.006 (1.6 ± 0.15)	0.031 ± 0.0046 (0.8 ± 0.15)	See Specific Value	0.008 (0.20)
0805	0.08 ± 0.008 (2.0 ± 0.20)	0.050 ± 0.008 (1.25 ± 0.20)	See Specific Value	0.010 (0.25)
1206	0.126 ± 0.008 (3.2 ± 0.20)	0.063 ± 0.008 (1.6 ± 0.20)	See Specific Value	0.010 (0.25)
1210	0.126 ± 0.0157 (3.2 ± 0.40)	0.098 ± 0.0118 (2.50 ± 0.30)	See Specific Value	0.010 (0.25)
1812	0.177 ± 0.012 (4.495 ± 0.30)	0.126 ± 0.012 (3.20 ± 0.30)	See Specific Value	0.010 (0.25)
2220	0.225 ± 0.016 (5.715 ± 0.41)	0.200 ± 0.006 (5.08 ± 0.41)	See Specific Value	0.010 (0.25)

* 0402 size in the X6S/X7S/X5R dielectrics will have a dimensional tolerance of ±0.20mm

STRUCTURE

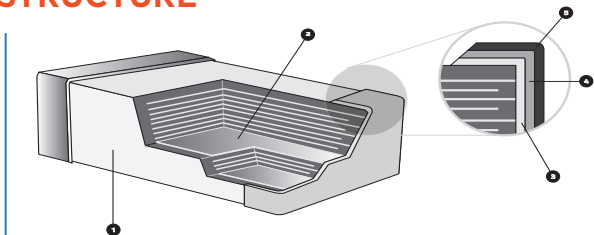

1	Ceramic Body (dielectric)	4	Nickel Plating
2	Inner Electrode	5	Tin Plating
3	Inner Termination		

ELECTRICAL SPECIFICATIONS

COG/COG

Typical Capacitance Change vs. Temperature

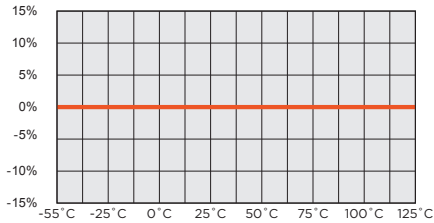

Operating Temperature Range:
-55°C to +125°C
Temperature Coefficient:
0 ±30PPM/°C
Temperature Voltage Coefficient:
0 ±30PPM/°C
Insulation Resistance:
>1000 Ω-F or 10 GΩ, for values ≤ 0.047µF (whichever is less at 25°C, WDCV).
For Capacitance values > 0.047µF, the 500 Ω-F rule applies. (The IR at 125°C is 10% of the value at 25°C)

Ageing:
None
Withstanding Voltage:
>2.5 times VDCW
Capacitance Tolerance:
B,C,D,F,G,J,K
Dissipation Factor:
0.1% max

X7R

Typical Capacitance Change vs. Temperature

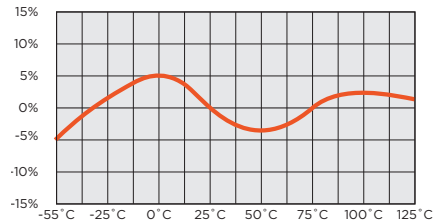

Operating Temperature Range:
-55°C to +125°C
Temperature Coefficient:
0 ±15%Δ°C MAX.
Temperature Voltage Coefficient:
X7R not applicable
Insulation Resistance:
>100 Ω-F or 10 GΩ, whichever is less at 25°C, VDCW. (The IR at 125°C is 10% of the value at 25°C)
Ageing:
2.5% per decade hour, typical
Withstanding Voltage:
>2.5 times VDCW
Capacitance Tolerance:
J,K,M

RATED VOLTAGE	D.F.	EXCEPTION OF D.F.	
		≤3%	EXCEPTION OF D.F.
≥50V	≤2.5%	≤3%	0201 (50V); 0603≥0.047µF 0805≥0.22µF; 1206≥0.47µF
		≤5%	0603≥1µF; 0805≥1µF; 1206≥4.7µF; 1210≥4.7µF
25V	≤2.5%	≤5%	0201≥0.01µF; 0805≥1µF; 1210≥4.7µF
		≤10%	0402≥0.10µF; 0603≥0.33µF; 0805≥2.2µF 1206≥2.2µF; 1210≥22µF
16V	≤3.5%	≤5%	0201≥0.01µF; 0402≥0.033µF; 0805≥0.68µF; 1206≥2.2µF; 1210≥4.7µF
		≤10%	0402≥0.47µF; 0603≥0.68µF; 0805≥2.2µF; 1206≥4.7µF; 1210≥22µF
10V	≤5%	≤10%	0402≥0.33µF; 0603≥0.33µF; 0805≥2.2µF; 1206≥2.2µF; 1210≥22µF
6.3V	≤10%		

X7S

Typical Capacitance Change vs. Temperature

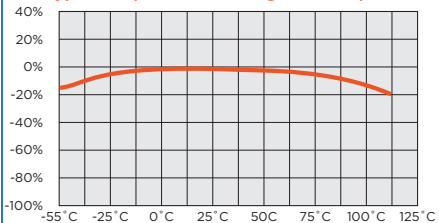

Operating Temperature Range:
-55°C to +125°C
Temperature Coefficient:
0 ±22%Δ°C MAX.
Insulation Resistance:
>1000 Ω-F or 100 GΩ, whichever is less at 25°C, VDCW. (The IR at 125°C is 10% of the value at 25°C)
Ageing:
2.5% per decade hour, typical
Withstanding Voltage:
>2.5 times VDCW
Capacitance Tolerance:
K,M

RATED VOLTAGE	D.F.	EXCEPTION OF D.F.	
		≤3%	EXCEPTION OF D.F.
≥50V	≤2.5%	≤3%	0201 (50V); 0603≥0.047µF 0805≥0.22µF; 1206≥0.47µF
		≤5%	0603≥1µF; 0805≥1µF; 1206≥4.7µF; 1210≥4.7µF
25V	≤2.5%	≤5%	0201≥0.01µF; 0805≥1µF; 1210≥4.7µF
		≤10%	0402≥0.10µF; 0603≥0.33µF; 0805≥2.2µF 1206≥4.7µF; 1210≥22µF
16V	≤3.5%	≤5%	0201≥0.01µF; 0402≥0.033µF; 0805≥0.68µF; 1206≥2.2µF; 1210≥4.7µF
		≤10%	0402≥0.47µF; 0603≥0.68µF; 0805≥2.2µF; 1206≥4.7µF; 1210≥22µF
≤10V	≤5%	≤10%	0402≥0.33µF; 0603≥0.33µF; 0805≥2.2µF; 1206≥2.2µF; 1210≥22µF
6.3V	≤10%		

ELECTRICAL SPECIFICATIONS

X6S

Typical Capacitance Change vs. Temperature

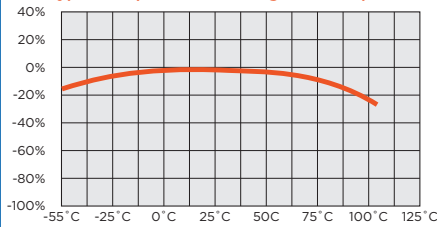

Operating Temperature Range:
-55°C to +105°C
Temperature Coefficient:
0 ±22%Δ°C MAX.
Insulation Resistance:
100,000 MΩ min., or 1000 MΩ (@ +25°C, RVDC) per uF min. or 100GW, whichever is less
Ageing:
2.5% per decade hour, typical
Withstanding Voltage:
>2.5 times VDCW
Capacitance Tolerance:
K,M

RATED VOLTAGE	D.F.	EXCEPTION OF D.F.	
≥50V	≤2.5%	≤3%	0201 (50V); 0603≥0.047uF 0805≥0.22uF; 1206≥0.47uF
		≤5%	0603≥1uF; 0805≥1uF; 1206≥4.7uF; 1210≥4.7uF
25V	≤2.5%	≤5%	0201≥0.01uF; 0805≥1uF; 1210≥4.7uF
		≤10%	0402≥0.10uF; 0603≥0.33uF; 0805≥2.2uF 1206≥4.7uF; 1210≥22uF
16V	≤3.5%	≤5%	0201≥0.01uF; 0402≥0.033uF; 0805≥0.68uF; 1206≥2.2uF; 1210≥4.7uF
		≤10%	0402≥0.47uF; 0603≥0.68uF; 0805≥2.2uF; 1206≥4.7uF; 1210≥22uF
≤10V	≤5%	≤10%	0402≥0.33uF; 0603≥0.33uF; 0805≥2.2uF; 1206≥2.2uF; 1210≥22uF
4V/6.3V	≤10%	≤15%	0402≥10uF

X5R

Typical Capacitance Change vs. Temperature

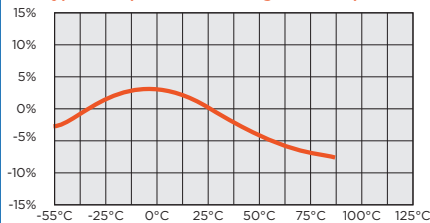

Operating Temperature Range:
-55°C to +85°C
Temperature Coefficient:
0 ±15%Δ°C MAX.
Insulation Resistance:
>100 Ω-F or 10 GΩ, whichever is less at 25°C, VDCW. (The IR at 125°C is 10% of the value at 25°C)
Ageing:
2.5% per decade hour, typical
Withstanding Voltage:
>2.5 times VDCW
Capacitance Tolerance:
K,M

RATED VOLTAGE	D.F.	EXCEPTION OF D.F.	
≥50V	≤2.5%	≤3%	0201 (50V); 0603≥0.047uF 0805≥0.22uF; 1206≥0.47uF
		≤5%	0603≥1uF; 0805≥1uF; 1206≥4.7uF; 1210≥4.7uF
25V	≤2.5%	≤5%	0201≥0.01uF; 0805≥1uF; 1210≥4.7uF
		≤10%	0402≥0.10uF; 0603≥0.33uF; 0805≥2.2uF 1206≥4.7uF; 1210≥22uF
16V	≤3.5%	≤5%	0201≥0.01uF; 0402≥0.033uF; 0805≥0.68uF; 1206≥2.2uF; 1210≥4.7uF
		≤10%	0402≥0.47uF; 0603≥0.68uF; 0805≥2.2uF; 1206≥4.7uF; 1210≥22uF
≤10V	≤5%	≤10%	0402≥0.33uF; 0603≥0.33uF; 0805≥2.2uF; 1206≥2.2uF; 1210≥22uF
6.3V	≤10%		

Z5U

Typical Capacitance Change vs. Temperature

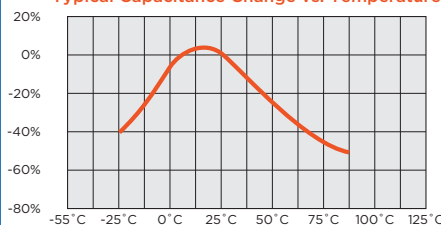

Operating Temperature Range:
+10°C to +85°C
Temperature Coefficient:
+22% - 56%Δ°C MAX.
Insulation Resistance:
>100 Ω-F or 10 GΩ, whichever is less at 25°C, VDCV. (The IR at 125°C is 10% of the value at 25°C)
Ageing:
5% per decade hour, typical
Withstanding Voltage:
>2.5 times VDCW
Capacitance Tolerance:
M,Z

RATED VOLTAGE	D.F.	EXCEPTION OF D.F.	
≥50V	≤5%	≤9%	0603≥0.1uF; 0805≥0.47uF; 1206≥4.7uF;
25V	≤5%	≤9%	0402≥0.047uF; 0603≥0.1uF; 0805≥0.33uF; 1206≥1uF; 1210≥4.7uF
		≤12.5%	0603≥2.2uF; 0805≥3.3uF; 1206≥10uF; 1210≥22uF; 1812≥47uF
16V	≤9%	≤16%	0603≥2.2uF; 0805≥3.3uF; 1206≥4.7uF; 1210≥10uF; 1812≥47uF
6.3V	≤16%		

Y5V

Typical Capacitance Change vs. Temperature

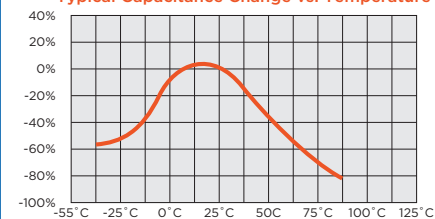

Operating Temperature Range:
-30°C to +85°C
Temperature Coefficient:
+22% - 82%Δ°C MAX.
Insulation Resistance:
>100 Ω-F or 10 GΩ, whichever is less at 25°C, VDCW. (The IR at 125°C is 10% of the value at 25°C)
Ageing:
7% per decade hour, typical
Withstanding Voltage:
>2.5 times VDCW
Capacitance Tolerance:
M,Z

RATED VOLTAGE	D.F.	EXCEPTION OF D.F.	
≥50V	≤5%	≤9%	0603≥0.1uF; 0805≥0.47uF; 1206≥4.7uF;
25V	≤5%	≤9%	0402≥0.047uF; 0603≥0.1uF; 0805≥0.33uF; ≥1206≥1uF; 1210≥4.7uF
		≤12.5%	0603≥2.2uF; 0805≥3.3uF; 1206≥10uF; 1210≥22uF; 1812≥47uF
16V	≤9%	≤16%	0603≥2.2uF; 0805≥3.3uF; 1206≥4.7uF; 1210≥10uF; 1812≥47uF
6.3V	≤16%		

TEST PARAMETERS

Test parameters for Multilayer Ceramic Capacitors
- X7R, X7S, X6S, X5R and Y5V:

1KHz ± 100Hz at 1.0 ± 0.2 Vrms < 10uF (10 V min.)
1KHz ± 100Hz at 1.0 ± 0.1 Vrms < 10uF (6.3V max.)
120Hz ± 24Hz at 1.0 ± 0.1 Vrms ≥ 10uF

Test parameters for Multilayer Ceramic Capacitors
- COG:

1MHz ± 100KHz at 1.0 ± 0.2 Vrms ≤ 1000pF, 25°C
1KHz ± 100Hz at 1.0 ± 0.2 Vrms > 1000pF, 25°C

NOTE: To ensure proper capacitance readings, the voltage level must be held constant. The HP4284 and Agilent E4980 has a "ALC" (Automatic Level Control) function and should be switched to the "ON" position for accurate capacitance readings.

VOLTAGE AND CAPACITANCE RANGE

COG (COG) DIELECTRIC

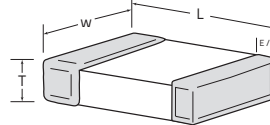

Values that are typically available.

(All measurements in inches)

SIZE		01005				0201		0402			0504		0603		0805			1206		1210		1812	
T (max)		0.008				0.012		0.025			0.040		0.033		0.055			0.075		0.103		0.110	
VDCW (MAX)		6.3V	16V	25V	50V	25V	50V	25V	50V	100V	50V	100V	50V	100V	25V	50V	100V	50V	100V	50V	100V	50V	100V
CAPACITANCE CODE	OR1	0.1pF																					
	OR2	0.2pF																					
	OR3	0.3pF																					
	OR4	0.4pF																					
	OR5	0.5pF																					
	1R0	1.0pF																					
	1R2	1.2pF																					
	1R5	1.5pF																					
	1R8	1.8pF																					
	2R2	2.2pF																					
	2R7	2.7pF																					
	3R3	3.3pF																					
	3R9	3.9pF																					
	4R7	4.7pF																					
	5R0	5.0pF																					
	5R6	5.6pF																					
	6R8	6.8pF																					
	8R2	8.2pF																					
	100	10pF																					
	120	12pF																					
	150	15pF																					
	180	18pF																					
220	22pF																						

NOTE: Additional values may be available. Please contact us for more information. Due to demand and raw material fluctuations, specific values may not be available.

VOLTAGE AND CAPACITANCE RANGE

COG (COG) DIELECTRIC

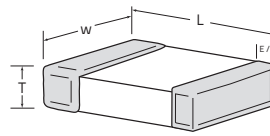

Values that are typically available.

(All measurements in inches)

SIZE		01005				0201		0402			0504		0603		0805			1206		1210		1812		2220 / 2221		
T (max)		0.008				0.012		0.025			0.040		0.033		0.055			0.075		0.103		0.110		0.134 / 0.134		
VDCW (MAX)		6.3V	16V	25V	50V	25V	50V	25V	50V	100V	50V	100V	50V	100V	25V	50V	100V	50V	100V	50V	100V	50V	100V	50V	100V	
270	27pF																									
330	33pF																									
390	39pF																									
470	47pF																									
560	56pF																									
680	68pF																									
820	82pF																									
101	100pF																									
121	120pF																									
151	150pF																									
181	180pF																									
221	220pF																									
271	270pF																									
331	330pF																									
391	390pF																									
471	470pF																									
561	560pF																									
681	680pF																									
821	820pF																									
102	1000pF																									
122	1200pF																									
152	1500pF																									
182	1800pF																									
222	2200pF																									
272	2700pF																									
332	3300pF																									
392	3900pF																									
472	4700pF																									
562	5600pF																									
682	6800pF																									
822	8200pF																									
103	.01uF																									
123	.012uF																									
153	.015uF																									
183	.018uF																									
223	.022uF																									
273	.027uF																									
333	.033uF																									
393	.039uF																									
473	.047uF																									
563	.056uF																									
683	.068uF																									
823	.082uF																									
104	.100uF																									
124	.120uF																									
154	.150uF																									
184	.180uF																									
224	.220uF																									
274	.270uF																									
334	.330uF																									
394	.390uF																									
474	.470uF																									
564	.560uF																									
684	.680uF																									
824	.820uF																									

NOTE: Additional values may be available. Please contact us for more information. Due to demand and raw material fluctuations, specific values may not be available.

VOLTAGE AND CAPACITANCE RANGE

X7R DIELECTRIC

Values that are typically available.

(All measurements in inches)

SIZE		01005		0201				0402				0504			0603					0805			
T (max)		0.008		0.012				0.025				0.040			0.038					0.058			
VDCW (MAX)		6.3V	10V	6.3V	10V	16V	25V	16V	25V	50V	100V	25V	50V	100V	10V	16V	25V	50V	100V	25V	50V	100V	
101	100pF																						
121	120pF																						
151	150pF																						
181	180pF																						
221	220pF																						
271	270pF																						
331	330pF																						
391	390pF																						
471	470pF																						
561	560pF																						
681	680pF																						
821	820pF																						
102	1000pF																						
122	1200pF																						
152	1500pF																						
182	1800pF																						
222	2200pF																						
272	2700pF																						
332	3300pF																						
392	3900pF																						
472	4700pF																						
562	5600pF																						
682	6800pF																						
822	8200pF																						
103	.01uF																						
123	.012uF																						
153	.015uF																						
183	.018uF																						
223	.022uF																						
273	.027uF																						
333	.033uF																						

* For values above 1uF, thickness may be greater than specified above.

T(max): 0603 - 0.040"

0805 - 0.060"

NOTE: Additional values may be available. Please contact us for more information. Due to demand and raw material fluctuations, specific values may not be available. All components manufactured with the X7R dielectric are also available as an X5R dielectric.

VOLTAGE AND CAPACITANCE RANGE

X7R DIELECTRIC

Values that are typically available.

(All measurements in inches)

SIZE	0201			0402					0603					0805						
T (max)*	0.012			0.025					0.038					0.059						
VDCW (MAX)	4V	6.3V	10V	6.3V	10V	16V	25V	50V	6.3V	10V	16V	25V	50V	100V	6.3V	10V	16V	25V	50V	100V
393																				
473																				
563																				
683																				
823																				
104	**	**	**																	
124																				
154																				
184																				
224																				
274																				
334																				
394																				
474																				
564																				
684																				
824																				
105																				
125																				
155																				
185																				
225																				
335																				
475																				
685																				
106																				
156																				35V
226																				
476																				
107																				

* For values above 1uF, thickness may be greater than specified above.

T(max): 0603 - 0.040"
 0805 - 0.060"

NOTE: Additional values may be available. Please contact us for more information. Due to demand and raw material fluctuations, specific values may not be available. All components manufactured with the X7R dielectric are also available as an X5R dielectric.

** RE: 0201, X7R, 0.1uF; When the operating temperature range is between 100°C and 125°C, it is recommended to apply the following voltage derating as shown in the diagram below.

DERATING CURVE FOR 0201, 0.1UF, X7R ONLY

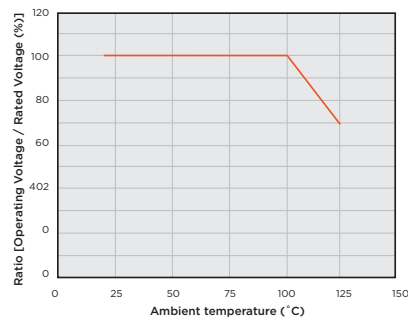

VOLTAGE AND CAPACITANCE RANGE

X7R DIELECTRIC

Values that are typically available.

(All measurements in inches)

SIZE		1206					1210					1812					2220 / 2221				
T (max)*		0.070					0.125					0.085					0.108 / 0.108				
VDCW (MAX)		10V	16V	25V	50V	100V	10V	16V	25V	50V	100V	6.3V	10V	16V	25V	50V	100V	16V	25V	50V	100V
102	1000pF																				
122	1200pF																				
152	1500pF																				
182	1800pF																				
222	2200pF																				
272	2700pF																				
332	3300pF																				
392	3900pF																				
472	4700pF																				
562	5600pF																				
682	6800pF																				
822	8200pF																				
103	.01uF																				
123	.012uF																				
153	.015uF																				
183	.018uF																				
223	.022uF																				
273	.027uF																				
333	.033uF																				
393	.039uF																				
473	.047uF																				
563	.056uF																				
683	.068uF																				
823	.082uF																				
104	.100uF																				
124	.120uF																				
154	.150uF																				
184	.180uF																				
224	.220uF																				
274	.270uF																				
334	.330uF																				

* For values above 1uF, thickness may be greater than specified above.

T(max): 0603 - 0.040"
 0805 - 0.060"

NOTE: Additional values may be available. Please contact us for more information. Due to demand and raw material fluctuations, specific values may not be available. All components manufactured with the X7R dielectric are also available as an X5R dielectric.

VOLTAGE AND CAPACITANCE RANGE

X7R DIELECTRIC

Values that are typically available.

(All measurements in inches)

SIZE		1206						1210						1812						2220 / 2221				
T (max)*		0.070						0.125						0.095						0.108 / 0.108				
VDCW (MAX)		6.3V	10V	16V	25V	50V	100V	6.3V	10V	16V	25V	50V	100V	6.3V	10V	16V	25V	50V	100V	16V	25V	50V	100V	
CAPACITANCE CODE	394	.390uF																						
	474	.470uF																						
	564	.560uF																						
	684	.680uF																						
	824	.820uF																						
	105	1.00uF																						
	125	1.20uF																						
	155	1.50uF																						
	185	1.80uF																						
	225	2.20uF																						
	335	3.30uF																						
	475	4.70uF																						
	685	6.80uF																						
	106	10.0uF																						
	156	15.0uF																				X7S/X7R	X7S/X7R	X7S/X7R
	226	22.0uF																						
	476	47.0uF																						
107	100.0uF																							

* For values above 1uF, thickness may be greater than specified above.

T(max): 1206 - 0.075" 1812 - 0.130"
 1210 - 0.125" 2220 - 0.135"

NOTE: Additional values may be available. Please contact us for more information. Due to demand and raw material fluctuations, specific values may not be available.
 All components manufactured with the X7R dielectric are also available as an X5R dielectric.

VOLTAGE AND CAPACITANCE RANGE

X7S DIELECTRIC (0201-0805)

Values that are typically available.

(All measurements in inches)

SIZE		0201				0402					0603					0805					
T (max)*		0.012				0.025					0.038					0.059					
VDCW (MAX)		4V	6.3V	10V	16V	6.3V	10V	16V	25V	50V	6.3V	10V	16V	25V	50V	6.3V	10V	16V	25V	50V	
CAPACITANCE CODE	104	CAPACITANCE VALUE	0.10uF																		
	224		0.22uF																		
	474		0.47uF																		
	105		1.00uF																		
	225		2.2uF																		
	475		4.7uF																		
	106		10.0uF																		
	226		22.0uF																		
	476		47.0uF																		
	107		100.0uF																		

X7S DIELECTRIC (1206-2220)

(All measurements in inches)

SIZE		1206					1210					1812				2220			
T (max)*		0.080					0.125					0.095				0.108			
VDCW (MAX)		6.3V	10V	16V	25V	50V	6.3V	10V	16V	25V	50V	16V	25V	50V	100V	16V	25V	50V	100V
CAPACITANCE CODE	104	CAPACITANCE VALUE	0.10uF																
	224		0.22uF																
	474		0.47																
	105		1.00uF																
	225		2.2uF																
	335		3.3uF																
	475		4.7uF																
	106		10.0uF																
	156		15.0uF																
	226		22.0uF																
476	47.0uF																		
107	100.0uF																		

* For values above 1uF, thickness may be greater than specified above.

T(max): 0603 - 0.040"
0805 - 0.060"

NOTE: Additional values may be available. Please contact us for more information. Due to demand and raw material fluctuations, specific values may not be available. All components manufactured with the X7R dielectric are also available as an X5R dielectric.

VOLTAGE AND CAPACITANCE RANGE

X6S DIELECTRIC (0201-0805)

Values that are typically available.

(All measurements in inches)

SIZE		0201				0402					0603					0805							
T (max)*		0.012				0.025					0.038					0.059							
VDCW (MAX)		4V	6.3V	10V	16V	6.3V	10V	16V	25V	50V	4V	6.3V	10V	16V	25V	50V	4V	6.3V	10V	16V	25V	50V	
CAPACITANCE CODE	104	CAPACITANCE VALUE	0.10uF																				
	224		0.22uF																				
	474		0.47uF																				
	105		1.00uF																				
	225		2.2uF																				
	475		4.7uF																				
	106		10.0uF																				
	226		22.0uF																				
	476		47.0uF																				
	107		100.0uF																				

X6S DIELECTRIC (1206-2220)

(All measurements in inches)

SIZE		1206					1210					1812				2220			
T (max)*		0.080					0.125					0.095				0.108			
VDCW (MAX)		6.3V	10V	16V	25V	50V	6.3V	10V	16V	25V	50V	16V	25V	50V	100V	16V	25V	50V	100V
CAPACITANCE CODE	104	CAPACITANCE VALUE	0.10uF																
	224		0.22uF																
	474		0.47uF																
	105		1.00uF																
	225		2.2uF																
	335		3.3uF																
	475		4.7uF																
	106		10.0uF																
	156		15.0uF																
	226		22.0uF																
476	47.0uF																		
107	100.0uF																		

* For values above 1uF, thickness may be greater than specified above.

T(max): 0603 - 0.040"

0805 - 0.060"

NOTE: Additional values may be available. Please contact us for more information. Due to demand and raw material fluctuations, specific values may not be available. All components manufactured with the X7R dielectric are also available as an X5R dielectric.

VOLTAGE AND CAPACITANCE RANGE

X5R DIELECTRIC

Values that are typically available.

(All measurements in inches)

SIZE		01005		0201				0402					0603					0805					1206				1210		1812					
T (max)		0.008		0.0216				0.025					0.040					0.060					0.072				0.125		0.130					
VDCW (MAX)		6.3V	10V	4V	6.3V	10V	16V	25V	4V	6.3V	10V	16V	25V	50V	6.3V	10V	16V	25V	35V	50V	6.3V	10V	16V	25V	50V	6.3V	10V	16V	25V	16V	25V	16V	25V	
102	1000pF																																	
122	1200pF																																	
152	1500pF																																	
182	1800pF																																	
222	2200pF																																	
272	2700pF																																	
332	3300pF																																	
392	3900pF																																	
472	4700pF																																	
562	5600pF																																	
682	6800pF																																	
822	8200pF																																	
103	.01uF																																	
153	.015uF																																	
223	.022uF																																	
333	.033uF																																	
393	.039uF																																	
473	.047uF																																	
104	0.10uF																																	
154	.150uF																																	
224	.220uF																																	
334	.330uF																																	
474	.470uF																																	
684	.680uF																																	
105	1.00uF																																	
125	1.20uF																																	
155	1.50uF																																	
185	1.80uF																																	
225	2.20uF																																	
335	3.30uF																																	

* For values above 1uF, thickness may be greater than specified above.

T(max): 1206 - 0.075" 1812 - 0.130"
 1210 - 0.125" 2220 - 0.135"

NOTE: Additional values may be available. Please contact us for more information. Due to demand and raw material fluctuations, specific values may not be available.
 All components manufactured with the X7R dielectric are also available as an X5R dielectric.

VOLTAGE AND CAPACITANCE RANGE

X5R DIELECTRIC (0402-1206)

Values that are typically available.

(All measurements in inches)

SIZE		0201			0402				0603					0805					1206						
T (max)		0.0216			0.0335				0.040					0.060					0.072						
VDCW (MAX)		4V	6.3V	10V	4V	6.3V	10V	16V	4V	6.3V	10V	16V	25V	4V	6.3V	10V	16V	25V	35V	50V	6.3V	10V	16V	25V	50V
CAPACITANCE CODE	395	3.90uF																							
	475	4.70uF																							
	685	6.80uF																							
	106	10.0uF																							
	156	15.0uF																							
	226	22.0uF																							
	476	47.0uF																							
	107	100.0uF																							
	157	150.0uF																							
	227	220.0uF																							

X5R DIELECTRIC (1210-2221)

(All measurements in inches)

SIZE		1210					1812				2220 / 2221				
T (max)		0.125					0.130				0.135				
VDCW (MAX)		6.3V	10V	16V	25V	50V	6.3V	10V	16V	25V	6.3V	10V	16V	25V	50V
CAPACITANCE CODE	395	3.90uF													
	475	4.70uF													
	685	6.80uF													
	106	10.0uF													
	156	15.0uF													
	226	22.0uF													
	476	47.0uF													
	107	100.0uF													
	157	150.0uF													
	227	220.0uF													

* For values above 1uF, thickness may be greater than specified above.

T(max): 1206 - 0.075" 1812 - 0.130"
 1210 - 0.125" 2220 - 0.135"

NOTE: Additional values may be available. Please contact us for more information. Due to demand and raw material fluctuations, specific values may not be available.
 All components manufactured with the X7R dielectric are also available as an X5R dielectric.

VOLTAGE AND CAPACITANCE RANGE

Z5U DIELECTRIC

Values that are typically available.

(All measurements in inches)

SIZE		0504		0603		0805		1206		1210		1812		2220 / 2221	
T (max)		0.040		0.038		0.058		0.070		0.075		0.085		0.108 / 0.108	
VDCW (MAX)		25V	50V	25V	50V	25V	50V	25V	50V	25V	50V	25V	50V	25V	50V
102	1000pF														
122	1200pF														
152	1500pF														
182	1800pF														
222	2200pF														
272	2700pF														
332	3300pF														
392	3900pF														
472	4700pF														
562	5600pF														
682	6800pF														
822	8200pF														
103	.01uF														
123	.012uF														
153	.015uF														
183	.018uF														
223	.022uF														
273	.027uF														
333	.033uF														
393	.039uF														
473	.047uF														
563	.056uF														
683	.068uF														
823	.082uF														
104	.100uF														
124	.120uF														
154	.150uF														
184	.180uF														
224	.220uF														
274	.270uF														
334	.330uF														

NOTE: Additional values may be available. Please contact us for more information. Due to demand and raw material fluctuations, specific values may not be available.

VOLTAGE AND CAPACITANCE RANGE

Z5U DIELECTRIC

Values that are typically available.

(All measurements in inches)

SIZE		0504		0603		0805		1206		1210		1812		2220 / 2221	
T (max)		0.040		0.038		0.058		0.070		0.075		0.085		0.108 / 0.108	
VDCW (MAX)		25V	50V	25V	50V	25V	50V	25V	50V	25V	50V	25V	50V	25V	50V
CAPACITANCE CODE	394	.390uF													
	474	.470uF													
	564	.560uF													
	684	.680uF													
	824	.820uF													
	105	1.00uF													
	125	1.20uF													
	155	1.50uF													
	185	1.80uF													
	225	2.20uF													
	335	3.30uF													
	395	3.90uF													
	475	4.70uF													
	685	6.80uF													
	106	10.0uF													
	156	15.0uF													
	226	22.0uF													
476	47.0uF														
107	100.0uF														

NOTE: Additional values may be available. Please contact us for more information. Due to demand and raw material fluctuations, specific values may not be available.
 For values above 1uF, thickness may be greater than specified above.

VOLTAGE AND CAPACITANCE RANGE

Y5V DIELECTRIC

Values that are typically available.

(All measurements in inches)

SIZE		0201			0402			0603			0805			1206			1210			1812									
T (max)		0.012			0.025			0.038			0.058			0.070			0.096			0.085									
VDCW (MAX)		10V	6.3V	10V	16V	25V	50V	6.3V	10V	16V	25V	50V	6.3V	10V	16V	25V	50V	10V	16V	25V	50V	6.3V	10V	16V	25V	6.3V	10V	25V	
CAPACITANCE CODE	102	1000pF																											
	122	1200pF																											
	152	1500pF																											
	182	1800pF																											
	222	2200pF																											
	272	2700pF																											
	332	3300pF																											
	392	3900pF																											
	472	4700pF																											
	562	5600pF																											
	682	6800pF																											
	822	8200pF																											
	CAPACITANCE VALUE	103	.01uF																										
		123	.012uF																										
		153	.015uF																										
		183	.018uF																										
		223	.022uF																										
		273	.027uF																										
		333	.033uF																										
		393	.039uF																										
		473	.047uF																										
		563	.056uF																										
	683	.068uF																											
	823	.082uF																											
	104	.100uF																											
	124	.120uF																											
	154	.150uF																											
	184	.180uF																											
	224	.220uF																											
	274	.270uF																											
	334	.330uF																											

NOTE: Additional values may be available. Please contact us for more information. Due to demand and raw material fluctuations, specific values may not be available. For values above 1uF, thickness may be greater than specified above.

VOLTAGE AND CAPACITANCE RANGE

Y5V DIELECTRIC

Values that are typically available.

(All measurements in inches)

SIZE		0201			0402			0603					0805					1206				1210					1812		
T (max)		0.012			0.025			0.038					0.058					0.070				0.10					0.085		
VDCW (MAX)		10V			6.3V	10V	16V	6.3V	10V	16V	25V	50V	6.3V	10V	16V	25V	50V	10V	16V	25V	50V	6.3V	10V	16V	25V	50V	6.3V	10V	25V
CAPACITANCE CODE	394	.390uF																											
	474	.470uF																											
	564	.560uF																											
	684	.680uF																											
	824	.820uF																											
	105	1.00uF																											
	125	1.20uF																											
	155	1.50uF																											
	185	1.80uF																											
	225	2.20uF																											
	335	3.30uF																											
	395	3.90uF																											
	475	4.70uF																											
	685	6.80uF																											
	106	10.0uF																											
	156	15.0uF																											
	226	22.0uF																											
	476	47.0uF																											
	107	100.0uF																											

NOTE: Additional values may be available. Please contact us for more information. Due to demand and raw material fluctuations, specific values may not be available.
 For values above 1uF, thickness may be greater than specified above.

TAPE & REEL SPECIFICATIONS

All tape and reel specifications must be adhered to per EIA-481-1-A.

REEL

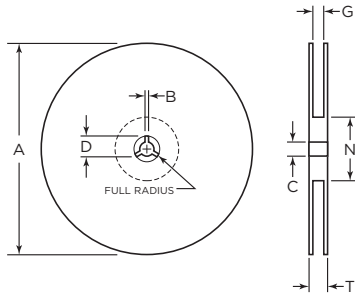

Unit: mm (inch)

Tape	B min	C	A (7")	A (13")	D min	N min	G	T max
4mm	2.0 (0.079)	13 ± 0.05 (0.512 ± 0.02)	178 ± 2.0 (7 ± 0.079)	-	21 ± 0.8 (0.82 ± 0.03)	50 (1.97)	5.0 ± 1.5 (0.196 ± 0.05)	8.0 max (0.315 max)
8mm	2.0 (0.07)	13 ± 0.05 (0.512 ± 0.02)	178 ± 2.0 (7 ± 0.079)	330 ± 2.0 (13 ± 0.08)	20.2 (0.795)	50 (1.97)	10 ± 1.5 (0.394 ± 0.059)	14.9 (0.587)
12mm	2.0 (0.07)	13 ± 0.05 (0.512 ± 0.02)	178 ± 2.0 (7 ± 0.079)	330 ± 2.0 (13 ± 0.08)	20.2 (0.795)	50 (1.97)	10 ± 1.5 (0.394 ± 0.059)	14.9 (0.587)

TAPE

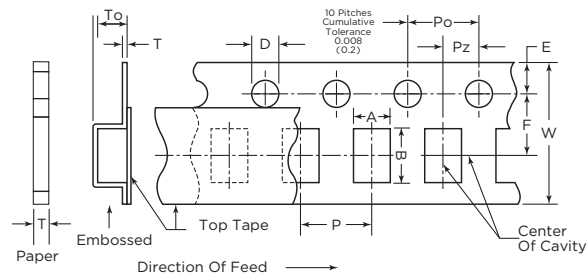

7" Reel Quantities **

SIZE	01005 (E)	01005 (P)	0201	0402	0603	0805	1206	1210	1812	2221
Tape Size	4mm	8mm	8mm	8mm	8mm	8mm	8mm	8mm	12mm	12mm
Min Qty Per Reel	40,000*	20000*	15,000	5,000	3,000	2,000	2,000	1,000	1,000	1,000
Max Qty Per Reel	40,000*	20000*	15,000	10,000	4,000	5,000	5,000	5,000	3,000	1,000

NOTE: ** Quantity dependent on thickness
 *Smaller quantities may be available. Please contact us.

Paper Tape Carrier Dimensions (8mm)

Unit: mm (inch)

Size (inches)	A	B	W	F	E	Po	Pz	D	t	P
01005	$\frac{0.25 \pm 0.05}{(0.010 \pm 0.002)}$	$\frac{0.45 \pm 0.05}{(0.018 \pm 0.002)}$	$\frac{8.0 \pm 0.2}{(0.315 \pm 0.008)}$	$\frac{3.5 \pm 0.1}{(0.138 \pm 0.004)}$	$\frac{1.75 \pm 0.1}{(0.069 \pm 0.004)}$	$\frac{4.0 \pm 0.1}{(0.157 \pm 0.004)}$	$\frac{2.0 \pm 0.05}{-0.0}$ $\frac{-0.0}{(0.039 \pm 0.002)}$ -0.000	$\frac{1.5 \pm 0.1}{(0.064 \pm .004)}$	$\frac{1.15 \text{ max}}{(0.045 \text{ max})}$	$\frac{2.0 \pm 0.05}{(0.079 \pm 0.002)}$
0201	$\frac{0.37 \pm 0.05}{(0.014 \pm 0.002)}$	$\frac{0.67 \pm 0.05}{(0.026 \pm 0.002)}$	$\frac{8.0 \pm 0.2}{(0.315 \pm 0.008)}$	$\frac{3.5 \pm 0.1}{(0.138 \pm 0.004)}$	$\frac{1.75 \pm 0.1}{(0.069 \pm 0.004)}$	$\frac{4.0 \pm 0.1}{(0.157 \pm 0.004)}$	$\frac{2.0 \pm 0.05}{-0.0}$ $\frac{-0.0}{(0.039 \pm 0.002)}$ -0.000	$\frac{1.5 \pm 0.1}{(0.064 \pm .004)}$	$\frac{1.15 \text{ max}}{(0.045 \text{ max})}$	$\frac{2.0 \pm 0.05}{(0.079 \pm 0.002)}$
0402	$\frac{0.65 \pm 0.1}{(0.026 \pm 0.004)}$	$\frac{1.10 \pm 0.2}{(0.043 \pm 0.008)}$	$\frac{8.0 \pm 0.2}{(0.315 \pm 0.008)}$	$\frac{3.5 \pm 0.1}{(0.138 \pm 0.004)}$	$\frac{1.75 \pm 0.1}{(0.069 \pm 0.004)}$	$\frac{4.0 \pm 0.1}{(0.157 \pm 0.004)}$	$\frac{2.0 \pm 0.05}{-0.0}$ $\frac{-0.0}{(0.039 \pm 0.002)}$ -0.000	$\frac{1.5 \pm 0.1}{(0.064 \pm .004)}$	$\frac{1.15 \text{ max}}{(0.045 \text{ max})}$	$\frac{2.0 \pm 0.05}{(0.079 \pm 0.002)}$
0603	$\frac{1.10 \pm 0.2}{(0.043 \pm 0.008)}$	$\frac{1.90 \pm 0.2}{(0.075 \pm 0.008)}$	$\frac{8.0 \pm 0.2}{(0.315 \pm 0.008)}$	$\frac{3.5 \pm 0.1}{(0.138 \pm 0.004)}$	$\frac{1.75 \pm 0.1}{(0.069 \pm 0.004)}$	$\frac{4.0 \pm 0.1}{(0.157 \pm 0.004)}$	$\frac{2.0 \pm 0.05}{-0.0}$ $\frac{-0.0}{(0.039 \pm 0.002)}$ -0.000	$\frac{1.5 \pm 0.1}{(0.064 \pm .004)}$	$\frac{1.15 \text{ max}}{(0.045 \text{ max})}$	$\frac{4.0 \pm 0.1}{(0.157 \pm 0.004)}$
0805	$\frac{1.16 \pm 0.2}{(0.046 \pm 0.008)}$	$\frac{2.4 \pm 0.2}{(0.095 \pm 0.008)}$	$\frac{8.0 \pm 0.2}{(0.315 \pm 0.008)}$	$\frac{3.5 \pm 0.1}{(0.138 \pm 0.004)}$	$\frac{1.75 \pm 0.1}{(0.069 \pm 0.004)}$	$\frac{4.0 \pm 0.1}{(0.157 \pm 0.004)}$	$\frac{2.0 \pm 0.05}{-0.0}$ $\frac{-0.0}{(0.039 \pm 0.002)}$ -0.000	$\frac{1.5 \pm 0.1}{(0.064 \pm .004)}$	$\frac{1.15 \text{ max}}{(0.045 \text{ max})}$	$\frac{4.0 \pm 0.1}{(0.157 \pm 0.004)}$
1206	$\frac{2.0 \pm 0.2}{(0.079 \pm 0.008)}$	$\frac{3.6 \pm 0.2}{(0.142 \pm 0.008)}$	$\frac{8.0 \pm 0.2}{(0.315 \pm 0.008)}$	$\frac{3.5 \pm 0.1}{(0.138 \pm 0.004)}$	$\frac{1.75 \pm 0.1}{(0.069 \pm 0.004)}$	$\frac{4.0 \pm 0.1}{(0.157 \pm 0.004)}$	$\frac{2.0 \pm 0.05}{-0.0}$ $\frac{-0.0}{(0.039 \pm 0.002)}$ -0.000	$\frac{1.5 \pm 0.1}{(0.064 \pm .004)}$	$\frac{1.15 \text{ max}}{(0.045 \text{ max})}$	$\frac{4.0 \pm 0.1}{(0.157 \pm 0.004)}$

Embossed Carrier Dimensions (4mm, 8mm & 12mm)

Size (inches)	A	B	W	F	E	Po	Pz	D	To	T	P
01005	$\frac{0.23}{(0.009)}$	$\frac{0.43}{(0.016)}$	$\frac{4.0 \pm 0.05}{(0.157 \pm 0.002)}$	$\frac{1.8 \pm 0.02}{(0.070 \pm 0.001)}$	$\frac{0.9 \pm 0.05}{(0.035 \pm 0.002)}$	$\frac{2.0 \pm 0.04}{(0.079 \pm 0.001)}$	$\frac{2.00}{(0.079)}$	$\frac{0.8 \pm 0.04}{(0.031 \pm 0.001)}$	$\frac{0.5 \text{ max}}{(0.019 \text{ max})}$	$\frac{0.15 - 0.4}{(0.005 - 0.015)}$	$\frac{1.00}{(0.039)}$
0603	$\frac{1.05 \pm 0.15}{(0.042 \pm 0.006)}$	$\frac{1.90 \pm 0.15}{(0.075 \pm 0.006)}$	$\frac{8.0 \pm 0.3}{(0.315 \pm 0.012)}$	$\frac{3.5 \pm 0.1}{(0.138 \pm .004)}$	$\frac{1.75 \pm 0.1}{(0.069 \pm .004)}$	$\frac{4.0 \pm 0.1}{(0.157 \pm .004)}$	$\frac{2.0 \pm 0.05}{(0.079 \pm .002)}$	$\frac{1.5 \pm 0.1}{-0.0}$ $\frac{-0.0}{(0.06 \pm .004)}$ -0.000	$\frac{0.75 \text{ max}}{(0.03 \text{ max})}$	$\frac{0.6 \text{ max}}{(0.024 \text{ max})}$	$\frac{4.0 \pm 0.1}{(0.157 \pm 0.004)}$
0805	$\frac{1.48 \pm 0.2}{(0.058 \pm 0.008)}$	$\frac{2.3 \pm 0.3}{(0.091 \pm .008)}$	$\frac{8.0 \pm 0.3}{(0.315 \pm 0.008)}$	$\frac{3.5 \pm 0.1}{(0.138 \pm 0.004)}$	$\frac{1.75 \pm 0.1}{(0.069 \pm 0.004)}$	$\frac{4.0 \pm 0.1}{(0.157 \pm 0.004)}$	$\frac{2.0 \pm 0.05}{(0.079 \pm 0.002)}$	$\frac{1.5 \pm 0.1}{-0.0}$ $\frac{-0.0}{(0.06 \pm 0.004)}$ -0.000	$\frac{2.5 \text{ max}}{(0.098 \text{ max})}$	$\frac{0.6 \text{ max}}{(0.024 \text{ max})}$	$\frac{4.0 \pm 0.1}{(0.157 \pm 0.004)}$
1206	$\frac{2.0 \pm 0.2}{(0.079 \pm 0.008)}$	$\frac{3.6 \pm 0.3}{(0.142 \pm 0.008)}$	$\frac{8.0 \pm 0.3}{(0.315 \pm 0.008)}$	$\frac{3.5 \pm 0.1}{(0.138 \pm 0.004)}$	$\frac{1.75 \pm 0.1}{(0.069 \pm 0.004)}$	$\frac{4.0 \pm 0.1}{(0.157 \pm 0.004)}$	$\frac{2.0 \pm 0.05}{(0.079 \pm 0.002)}$	$\frac{1.5 \pm 0.1}{-0.0}$ $\frac{-0.0}{(0.06 \pm 0.004)}$ -0.000	$\frac{2.5 \text{ max}}{(0.098 \text{ max})}$	$\frac{0.6 \text{ max}}{(0.024 \text{ max})}$	$\frac{4.0 \pm 0.1}{(0.157 \pm 0.004)}$
1210	$\frac{2.9 \pm 0.2}{(0.114 \pm 0.008)}$	$\frac{3.6 \pm 0.3}{(0.142 \pm 0.008)}$	$\frac{8.0 \pm 0.3}{(0.315 \pm 0.008)}$	$\frac{3.5 \pm 0.1}{(0.138 \pm 0.004)}$	$\frac{1.75 \pm 0.1}{(0.069 \pm 0.004)}$	$\frac{4.0 \pm 0.1}{(0.157 \pm 0.004)}$	$\frac{2.0 \pm 0.05}{(0.079 \pm 0.002)}$	$\frac{1.5 \pm 0.1}{-0.0}$ $\frac{-0.0}{(0.06 \pm 0.004)}$ -0.000	$\frac{2.5 \text{ max}}{(0.098 \text{ max})}$	$\frac{0.6 \text{ max}}{(0.024 \text{ max})}$	$\frac{4.0 \pm 0.1}{(0.157 \pm 0.004)}$
1812	$\frac{3.6 \pm 0.2}{(0.142 \pm 0.008)}$	$\frac{4.9 \pm 0.3}{(0.193 \pm 0.008)}$	$\frac{12.0 \pm 0.3}{(0.472 \pm 0.012)}$	$\frac{5.6 \pm 0.1}{(0.221 \pm 0.004)}$	$\frac{1.75 \pm 0.1}{(0.069 \pm 0.004)}$	$\frac{4.0 \pm 0.1}{(0.157 \pm 0.004)}$	$\frac{2.0 \pm 0.05}{(0.079 \pm 0.002)}$	$\frac{1.5 \pm 0.1}{-0.0}$ $\frac{-0.0}{(0.06 \pm 0.004)}$ -0.000	$\frac{3.8 \text{ max}}{(0.150 \text{ max})}$	$\frac{0.6 \text{ max}}{(0.024 \text{ max})}$	$\frac{8.0 \pm 0.1}{(0.315 \pm 0.004)}$

ENVIRONMENTAL CHARACTERISTICS

NO	ITEM		PERFORMANCE	TEST CONDITION						
1	APPEARANCE		NO ABNORMAL EXTERIOR APPEARANCE	THROUGH MICROSCOPE (X10)						
2	INSULATION RESISTANCE		10,000M OR 500M μ F PRODUCT WHICHEVER IS SMALLER (RATED VOLTAGE IS BELOW 16V: 10,000M OR 100M μ F)	RATED VOLTAGE SHALL BE APPLIED. MEASUREMENT TIME IS 60 - 120 RATED VOLTAGE TIME 60 SEC .						
3	WITHSTANDING VOLTAGE		NO DIELECTRIC BREAKDOWN OR MECHANICAL BREAKDOWN	CLASS I : 300% OF THE RATED VOLTAGE FOR 1-5 SEC. CLASS II: 250% OF THE RATED VOLTAGE FOR 1-5 SEC IS APPLIED WITH LESS THAN 50mA CURRENT						
4	CAPACITANCE	CLASS I	WITHIN THE SPECIFIED TOLERANCE	CAPACITANCE	FREQUENCY	VOLTAGE				
				1,000pF AND BELOW	1MHZ \pm 10%	0.5 - 5 Vrms				
		MORE THAN 1,000 pF		1kHz \pm 10%						
		CLASS II		CAPACITANCE	FREQUENCY	VOLTAGE				
4.7 μ F AND BELOW	1kHz \pm 10%		1.0 \pm 0.2Vrms							
			MORE THAN 4.7 μ F	120HZ \pm 20%	1.0 \pm 0.2Vrms					
5	Q	CLASS I	OVER 30pF : Q 1,000 LESS THAN 30pF: Q 400 +20C (C: CAPACITANCE)	CAPACITANCE	FREQUENCY	VOLTAGE				
				1,000pF AND BELOW	1MHZ \pm 10%	0.5 - 5 Vrms				
				MORE THAN 1,000 pF	1kHz \pm 10%					
6	DISSIPATION FACTOR (Tan θ CLASS II)	CLASS II	X7R, X6S, X5R							
			Rated Voltage	D.F.	Exception of D.F.					
			\geq 50V	\leq 2.5%	\leq 3%	0201 (50V); 0603 \geq 0.047 μ F 0805 \geq 0.22 μ F; 1206 \geq 0.47 μ F				
					\leq 5%	0603 \geq 1 μ F; 0805 \geq 1 μ F; 1206 \geq 4.7 μ F; 1210 \geq 4.7 μ F				
			25V	\leq 2.5%	\leq 5%	0201 \geq 0.01 μ F; 0805 \geq 1 μ F; 1210 \geq 4.7 μ F				
					\leq 10%	0402 \geq 0.10 μ F; 0603 \geq 0.33 μ F; 0805 \geq 2.2 μ F 1206 \geq 4.7 μ F; 1210 \geq 22 μ F				
			16V	\leq 3.5%	\leq 5%	0201 \geq 0.01 μ F; 0402 \geq 0.033 μ F; 0805 \geq 0.68 μ F; 1206 \geq 2.2 μ F; 1210 \geq 4.7 μ F				
					\leq 10%	0402 \geq 0.47 μ F; 0603 \geq 0.68 μ F; 0805 \geq 2.2 μ F; 1206 \geq 4.7 μ F; 1210 \geq 22 μ F				
			10V	\leq 5%	\leq 10%	0402 \geq 0.33 μ F; 0603 \geq 0.33 μ F; 0805 \geq 2.2 μ F; 1206 \geq 2.2 μ F; 1210 \geq 22 μ F				
			6.3V	\leq 10%						
						Y5V, Z5U				
			Rated Voltage	D.F.	Exception of D.F.					
			\geq 50V	\leq 5%	\leq 9%	0603 \geq 0.1 μ F; 0805 \geq 0.47 μ F; 1206 \geq 4.7 μ F;				
			25V	\leq 5%	\leq 9%	0402 \geq 0.047 μ F; 0603 \geq 0.1 μ F; 0805 \geq 0.33 μ F; 1206 \geq 1 μ F; 1210 \geq 4.7 μ F				
\leq 12.5%	0603 \geq 2.2 μ F; 0805 \geq 3.3 μ F; 1206 \geq 10 μ F; 1210 \geq 22 μ F; 1812 \geq 47 μ F									
16V	\leq 9%	\leq 16%	0603 \geq 2.2 μ F; 0805 \geq 3.3 μ F; 1206 \geq 4.7 μ F; 1210 \geq 10 μ F; 1812 \geq 47 μ F							
10V	\leq 12.5%	\leq 16%								
6.3V	\leq 16%									

ENVIRONMENTAL CHARACTERISTICS

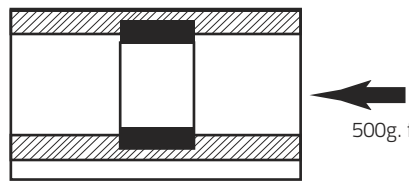
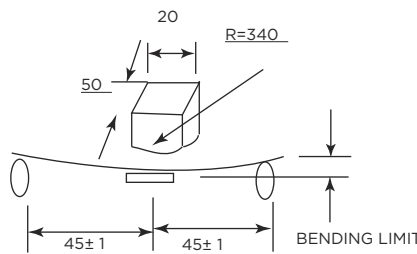
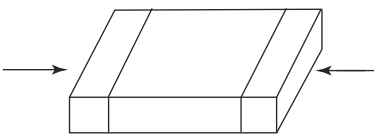
NO	ITEM		PERFORMANCE		TEST CONDITION			
			CHARACTERISTIC	TEMP. COEFFICIENT (PPM/°C)	THESE SYMMETRICAL TOLERANCE APPLY TO 2 POINT MEASUREMENT OF TEMPERATURE COEFFICIENT: ONE AT -25°C AND AT 85°C			
7	CAPACITANCE TEMPERATURE COEFFICIENT	CLASS I	COG/COG	0 ± 60 (±30)	STEP	TEMPERATURE (°C)		
				-150 ± 60	1	25 ± 2		
				-220 ± 60	2	MIN RATED TEMP ± 2		
				-330 ± 60	3	25 ± 2		
				-470 ± 60	4	MAX RATED TEMP ± 2		
				-750 ± 120	5	25 ± 2		
				+350 - -1000				
8	TEMPERATURE CHARACTERISTICS	CLASS II	CAPACITANCE CHANGE		STEP	TEMP. (°C) B	TEMP. (°C) F	
			CHAR.	CAP. CHANGE (%)				1
			X	X7R ±15%	2	-55 ± 2	-25 ± 2	
				X6S ±22%	3	25 ± 2	25 ± 2	
				X5R ±15%	4	125 ± 2	85 ± 2	
			Y	Y5V -82% - +22%	5	25 ± 2	25 ± 2	
				Z5U -56% - +22%	$\frac{C2 - C1}{C1} \times 100\%$ C1: CAPACITANCE AT STANDARD TEMPERATURE (25°C) C2: CAPACITANCE AT EACH TEMPERATURE			
9	ADHESIVE STRENGTH OF TERMINATION	NO INDICATION OF PEELING SHALL OCCUR ON THE TERMINAL ELECTRODE			A 500g.f PRESSURE SHALL BE APPLIED FOR 10±1 SECOND 			
10	BENDING STRENGTH	APPEARANCE	NO MECHANICAL DAMAGE SHALL OCCURE			BENDING SHALL BE APPLIED TO THE LIMIT (1mm) WITH 0.3mm/SEC		
		CAPACITANCE	CHARACTER	CHANGE OF CAPACITANCE				
			CLASS I	WITHIN ±5% OR ±0.5pF WHICHEVER IS LARGER				
			CLASS II	X (X7R, X6S, X5R)	WITHIN ±12.5%			
			Y (Y5V, Z5U)	WITHIN ±30%				
11	SOLDERABILITY	MORE THAN 75% OF THE TERMINAL SURFACE IS TO BE SOLDERED NEWLY, SO METAL PART (A) DOES NOT COME OUT OR DISSOLVE 			SOLDER TEMPERATURE: 245 ± 5 °C SOLDER: Sn_Ag3_0.5Cu FLUX: RMA Type PRE-HEATING: AT 80 - 120 °C FOR 10 - 30 SEC.			

ENVIRONMENTAL CHARACTERISTICS

NO	ITEM	PERFORMANCE	TEST CONDITION									
12	RESISTANCE TO SOLDERING HEAT	APPEARANCE	NO MECHANICAL DAMAGE SHALL OCCUR									
		CAPACITANCE	CHARACTERISTIC	CAP. CHANGE								
			CLASS I	WITHIN ±2.5% OR ±0.25 pF WHICHEVER IS LARGER								
			CLASS II	X	WITHIN ±7.5%							
				Y	WITHIN ±20%							
		QCLASS I	30 pF AND OVER: Q 1000 LESS THAN 30 pF: Q 400 + 20xC									
		Tan CLASS II	TO SATISFY THE SPECIFIED INITIAL VALUE									
		INSULATION RESISTANCE	TO SATISFY THE SPECIFIED INITIAL VALUE									
WITHSTANDING VOLTAGE	TO SATISFY THE SPECIFIED INITIAL VALUE											
13	VIBRATION TEST	APPEARANCE	NO MECHANICAL DAMAGE SHALL OCCUR									
		CAPACITANCE	CHARACTERISTIC	CAP. CHANGE								
			CLASS I	WITHIN ±2.5% OR ±0.25 pF WHICHEVER IS LARGER								
			CLASS II	X	WITHIN ±5%							
				Y	WITHIN ±20%							
		QCLASS I	30 pF AND OVER: Q 1000 LESS THAN 30 pF: Q 400 + 20xC									
		Tan CLASS II	TO SATISFY THE SPECIFIED INITIAL VALUE									
		INSULATION RESISTANCE	TO SATISFY THE SPECIFIED INITIAL VALUE									
			<p>DIP : SOLDER TEMPERATURE OF 270± 5 °C DIP TIME :10±1 SEC. EACH TERMINATION SHALL BE FULLY IMMERSSED AND PREHEATED AS FOLLOWING:</p> <table border="1"> <thead> <tr> <th>STEP</th> <th>TEMP. (°C)</th> <th>TIME (SEC.)</th> </tr> </thead> <tbody> <tr> <td>1</td> <td>80-100</td> <td>60</td> </tr> <tr> <td>2</td> <td>150-180</td> <td>60</td> </tr> </tbody> </table> <p>MEASURE AT ROOM TEMP. AFTER COOLING FOR CLASS I : 24 ± 2 HOURS CLASS II : 48 ± 4 HOURS</p>	STEP	TEMP. (°C)	TIME (SEC.)	1	80-100	60	2	150-180	60
STEP	TEMP. (°C)	TIME (SEC.)										
1	80-100	60										
2	150-180	60										
			<p>THE CAPACITOR SHALL BE SUBJECTED TO A HARMONIC MOTION HAVING A TOTAL AMPLITUDE of 1.5mm</p> <p>THE ENTIRE FREQUENCY RANGE, FROM 10 TO 55Hz AND RETURN TO 10Hz SHALL BE TRAVERSED IN 1 MINUTE.</p> <p>THIS CYCLE SHALL BE PERFORMED 2 HOURS IN EACH THREE MUTUALLY PERPENDICULAR DIRECTION, FOR TOTAL PERIOD of 6 HOURS.</p>									

ENVIRONMENTAL CHARACTERISTICS

NO	ITEM	PERFORMANCE	TEST CONDITION			
14	APPEARANCE	NO MECHANICAL DAMAGE SHALL OCCUR	TEMPERATURE : 40±2 °C RELATIVE HUMIDITY: 90-95 %RH TEST TIME : 500 +12/-0 Hr. MEASURE AT ROOM TEMPERATURE AFTER COOLING FOR CLASS I : 24±2 Hr. CLASS II : 48±4 Hr. SEE (FIG.3)			
	CAPACITANCE	CHARACTERISTIC		CAPACITANCE CHANGE		
		CLASS I		WITHIN ±5% OR±0.5pF WHICHEVER IS LARGER		
		CLASS II		X	WITHIN ±12.5%	
				Y	WITHIN ±30%	
	QCLASS I	30pF AND OVER : Q 350 10 - 30pF : Q 275 + 2.5xC LESS THAN 10pF : Q 200 + 10xC				
	DISSIPATION FACTOR (Tanθ CLASS II)	X7R, X6S, X5R				
		Rated Voltage		D.F.	Exception of D.F.	
		≥50V		≤2.5%	≤3%	0201 (50V); 0603≥0.047uF 0805≥0.22uF; 1206≥0.47uF
					≤5%	0603≥1uF; 0805≥1uF; 1206≥4.7uF; 1210≥4.7uF
25V		≤2.5%	≤5%	0201≥0.01uF; 0805≥1uF; 1210≥4.7uF		
			≤10%	0402≥0.10uF; 0603≥0.33uF; 0805≥2.2uF 1206≥4.7uF; 1210≥22uF		
16V		≤3.5%	≤5%	0201≥0.01uF; 0402≥0.033uF; 0805≥0.68uF; 1206≥2.2uF; 1210≥4.7uF		
			≤10%	0402≥0.47uF; 0603≥0.68uF; 0805≥2.2uF; 1206≥4.7uF; 1210≥22uF		
10V		≤5%	≤10%	0402≥0.33uF; 0603≥0.33uF; 0805≥2.2uF; 1206≥2.2uF; 1210≥22uF		
6.3V		≤10%				
Y5V, Z5U						
Rated Voltage	D.F.	Exception of D.F.				
≥50V	≤5%	≤9%	0603≥0.1uF; 0805≥0.47uF; 1206≥4.7uF;			
25V	≤5%	≤9%	0402≥0.047uF; 0603≥0.1uF; 0805≥0.33uF; 1206≥1uF; 1210≥4.7uF			
16V	≤9%	≤12.5%	0603≥2.2uF; 0805≥3.3uF; 1206≥10uF; 1210≥22uF; 1812≥47uF			
10V	≤12.5%	≤16%	0603≥2.2uF; 0805≥3.3uF; 1206≥4.7uF; 1210≥10uF; 1812≥47uF			
6.3V	≤16%					
INSULATION RESISTANCE	MINIMUM INSULATION RESISTANCE: 1,000M OR 50M µF PRODUCT WHICHEVER IS SMALLER					

ENVIRONMENTAL CHARACTERISTICS

NO	ITEM	PERFORMANCE	TEST CONDITION			
15	APPEARANCE	NO MECHANICAL DAMAGE SHALL OCCUR	APPLIED VOLTAGE: RATED VOLTAGE TEMPERATURE : 40±2 °C RELATIVE HUMIDITY: 90-95%RH TEST TIME : 500 +12/-0 Hr. CURRENT APPLIED: 50mA MAX. MEASURING AT ROOM TEMPERATURE AFTER COOLING FOR CLASS I : 24±2 Hr. CLASS II : 48±4 Hr. SEE (FIG.3)			
	CAPACITANCE	CHARACTERISTIC		CAPACITANCE CHANGE		
		CLASS I		WITHIN ±7.5% OR±0.75pF WHICHEVER IS LARGER		
		CLASS II		X	WITHIN ±12.5%	
	Y			WITHIN ±30%		
	QCLASS I	30pF AND OVER : Q 200 30pF AND BELOW : Q 100 + 10/3xC				
	DISSIPATION FACTOR (Tanθ CLASS II)	X7R, X6S, X5R				
		Rated Voltage		D.F.	Exception of D.F.	
		≥50V		≤2.5%	≤3%	0201 (50V); 0603≥0.047uF 0805≥0.22uF; 1206≥0.47uF
					≤5%	0603≥1uF; 0805≥1uF; 1206≥4.7uF; 1210≥4.7uF
25V		≤2.5%	≤5%	0201≥0.01uF; 0805≥1uF; 1210≥4.7uF		
			≤10%	0402≥0.10uF; 0603≥0.33uF; 0805≥2.2uF 1206≥4.7uF; 1210≥22uF		
16V		≤3.5%	≤5%	0201≥0.01uF; 0402≥0.033uF; 0805≥0.68uF; 1206≥2.2uF; 1210≥4.7uF		
			≤10%	0402≥0.47uF; 0603≥0.68uF; 0805≥2.2uF; 1206≥4.7uF; 1210≥22uF		
10V		≤5%	≤10%	0402≥0.33uF; 0603≥0.33uF; 0805≥2.2uF; 1206≥2.2uF; 1210≥22uF		
6.3V	≤10%					
Y5V, Z5U						
Rated Voltage	D.F.	Exception of D.F.				
≥50V	≤5%	≤9%	0603≥0.1uF; 0805≥0.47uF; 1206≥4.7uF;			
25V	≤5%	≤9%	0402≥0.047uF; 0603≥0.1uF; 0805≥0.33uF; 1206≥1uF; 1210≥4.7uF			
16V	≤9%	≤12.5%	0603≥2.2uF; 0805≥3.3uF; 1206≥10uF; 1210≥22uF; 1812≥47uF			
10V	≤12.5%	≤16%	0603≥2.2uF; 0805≥3.3uF; 1206≥4.7uF; 1210≥10uF; 1812≥47uF			
6.3V	≤16%					
INSULATION RESISTANCE	MINIMUM INSULATION RESISTANCE: 100 M OR 25M μF PRODUCT, WHICHEVER IS SMALLER					

ENVIRONMENTAL CHARACTERISTICS

NO	ITEM	PERFORMANCE	TEST CONDITION			
16	APPEARANCE	NO MECHANICAL DAMAGE SHALL OCCUR	APPLIED VOLTAGE: 200% OF RATED VOLTAGE TEST TIME : 1000 +48/-0 Hr. CURRENT APPLIED: 50mA MAX.			
	CAPACITANCE	CHARACTERISTIC		CAP. CHANGE		
		CLASS I		WITHIN ±3% OR ±0.3pF, WHICHEVER IS LARGER		
		CLASS II		X	WITHIN ±12.5%	
	Y		WITHIN ±30%			
	QCLASS I	30pF AND OVER : Q 350 10 - 30 pF : Q 275 + 2.5xC LESS THAN 10pF :Q 200 + 10xC	CLASS I 125 ±3 °C			
	DISSIPATION FACTOR (Tanθ CLASS II)	X7R, X6S, X5R		(INITIAL VALUE MEASUREMENT) FOR CLASS II CAPACITORS, 200 % OF RATED VOLTAGE SHALL BE APPLIED FOR 1 HOUR AT THE MAXIMUM OPERATING TEMPERATURE, THEN KEEP IT AT ROOM TEMPERATURE FOR 48 ±4 HRS. SEE (FIG.3)		
		Rated Voltage	D.F.		Exception of D.F.	
		≥50V	≤2.5%		≤3%	0201 (50V); 0603≥0.047uF 0805≥0.22uF; 1206≥0.47uF
					≤5%	0603≥1uF; 0805≥1uF; 1206≥4.7uF; 1210≥4.7uF
25V		≤2.5%	≤5%		0201≥0.01uF; 0805≥1uF; 1210≥4.7uF	
			≤10%		0402≥0.10uF; 0603≥0.33uF; 0805≥2.2uF 1206≥4.7uF; 1210≥22uF	
16V		≤3.5%	≤5%		0201≥0.01uF; 0402≥0.033uF; 0805≥0.68uF; 1206≥2.2uF; 1210≥4.7uF	
			≤10%		0402≥0.47uF; 0603≥0.68uF; 0805≥2.2uF; 1206≥4.7uF; 1210≥22uF	
10V		≤5%	≤10%		0402≥0.33uF; 0603≥0.33uF; 0805≥2.2uF; 1206≥2.2uF; 1210≥22uF	
6.3V		≤10%				
Y5V, Z5U						
Rated Voltage	D.F.	Exception of D.F.				
≥50V	≤5%	≤9%	0603≥0.1uF; 0805≥0.47uF; 1206≥4.7uF;			
25V	≤5%	≤9%	0402≥0.047uF; 0603≥0.1uF; 0805≥0.33uF; 1206≥1uF; 1210≥4.7uF			
16V	≤9%	≤12.5%	0603≥2.2uF; 0805≥3.3uF; 1206≥10uF; 1210≥22uF; 1812≥47uF			
10V	≤12.5%	≤16%	0603≥2.2uF; 0805≥3.3uF; 1206≥4.7uF; 1210≥10uF; 1812≥47uF			
6.3V	≤16%					
INSULATION RESISTANCE	MINIMUM INSULATION RESISTANCE: 1,000M OR 50M μF PRODUCT WHICHEVER IS SMALLER					

ENVIRONMENTAL CHARACTERISTICS

NO	ITEM	PERFORMANCE	TEST CONDITION															
17	TEMPERATURE CYCLE	APPEARANCE	CAPACITORS SHALL BE SUBJECTED TO FIVE CYCLES OF THE TEMPERATURE CYCLE AS FOLLOWING <table border="1"> <thead> <tr> <th>STEP</th> <th>TEMP.(°C)</th> <th>TIME (MIN)</th> </tr> </thead> <tbody> <tr> <td>1</td> <td>MIN. RATED TEMP. +0/-3</td> <td>30</td> </tr> <tr> <td>2</td> <td>25</td> <td>2 - 3</td> </tr> <tr> <td>3</td> <td>MAX. RATED TEMP. +3/-0</td> <td>30</td> </tr> <tr> <td>4</td> <td>25</td> <td>2 - 3</td> </tr> </tbody> </table>	STEP	TEMP.(°C)	TIME (MIN)	1	MIN. RATED TEMP. +0/-3	30	2	25	2 - 3	3	MAX. RATED TEMP. +3/-0	30	4	25	2 - 3
		STEP		TEMP.(°C)	TIME (MIN)													
		1		MIN. RATED TEMP. +0/-3	30													
		2		25	2 - 3													
		3		MAX. RATED TEMP. +3/-0	30													
		4		25	2 - 3													
		NO MECHANICAL DAMAGE SHALL OCCUR																
		CAPACITANCE		CHARACTERISTIC	CAP. CHANGE													
				CLASS I		WITHIN ±2.5% OR ±0.25pF WHICHEVER IS LARGER												
				CLASS II	X	WITHIN ±7.5%												
Y	WITHIN ±20%																	
QCLASS I	30 pF AND OVER : Q 1000 LESS THAN 30pF:Q 400 +20xC																	
TAN CLASS II	X7R, X6S, X5R																	
	Rated Voltage	D.F.	Exception of D.F.															
	≥50V	≤2.5%	≤3%	0201 (50V); 0603≥0.047uF 0805≥0.22uF; 1206≥0.47uF														
			≤5%	0603≥1uF; 0805≥1uF; 1206≥4.7uF; 1210≥4.7uF														
	25V	≤2.5%	≤5%	0201≥0.01uF; 0805≥1uF; 1210≥4.7uF														
			≤10%	0402≥0.10uF; 0603≥0.33uF; 0805≥2.2uF 1206≥4.7uF; 1210≥22uF														
	16V	≤3.5%	≤5%	0201≥0.01uF; 0402≥0.033uF; 0805≥0.68uF; 1206≥2.2uF; 1210≥4.7uF														
			≤10%	0402≥0.47uF; 0603≥0.68uF; 0805≥2.2uF; 1206≥4.7uF; 1210≥22uF														
	10V	≤5%	≤10%	0402≥0.33uF; 0603≥0.33uF; 0805≥2.2uF; 1206≥2.2uF; 1210≥22uF														
	6.3V	≤10%																
	Y5V, Z5U																	
	Rated Voltage	D.F.	Exception of D.F.															
	≥50V	≤5%	≤9%	0603≥0.1uF; 0805≥0.47uF; 1206≥4.7uF;														
	25V	≤5%	≤9%	0402≥0.047uF; 0603≥0.1uF; 0805≥0.33uF; 1206≥1uF; 1210≥4.7uF														
16V	≤9%	≤12.5%	0603≥2.2uF; 0805≥3.3uF; 1206≥10uF; 1210≥22uF; 1812≥47uF															
10V	≤12.5%	≤16%	0603≥2.2uF; 0805≥3.3uF; 1206≥4.7uF; 1210≥10uF; 1812≥47uF															
6.3V	≤16%																	
INSULATION RESISTANCE	TO SATISFY THE SPECIFIED INITIAL VALUE																	

ENVIRONMENTAL CHARACTERISTICS

NO	ITEM	TEST CONDITION	REQUIREMENTS																																																																																																																					
18	HIGH TEMPERATURE Load-Endurance (Life Testing)	*Test Temperature: COG, X7R/X7S: 125±3°C X5R, Y5V: 85±3°C Test time: 1000+24/-0 hrs. Endurance or Life Test Voltage (RVLL) * All components are tested at 100% of rated voltage (Vr) for the below range:	• No remarkable damage. CAP CHANGE: COG: ±3.0% or ±0.3pF whichever is larger X7R, X5R, X6S, X7S: ≥10V**, within ±12.5%; ≤6.3V within ±25%; **10V: 0603≥4.7µF; 0402≥1.0µF; 0201≥0.1µF, within ±25% Y5V≥10V, within ±30%; ≤6.3V, within +30/-40% Q/D.F. VALUE: COG: More than 30pF, Q≥350 10pF≤30pF, Q≥275+2.5C Less than 10pF, Q≥200+10C																																																																																																																					
		<table border="1"> <thead> <tr> <th>SIZE</th> <th>DIELECTRIC</th> <th>RATED VOLTAGE</th> <th>CAPACITANCE</th> </tr> </thead> <tbody> <tr> <td rowspan="2">0201</td> <td rowspan="2">X5R/X7R/X6S</td> <td>≤10V</td> <td>C≥0.1µF</td> </tr> <tr> <td>≥16V</td> <td>C>0.1µF</td> </tr> <tr> <td rowspan="6">0402</td> <td rowspan="2">X5R</td> <td>≤16V</td> <td>C>0.1µF</td> </tr> <tr> <td>25V, 50V</td> <td>C≥0.1µF</td> </tr> <tr> <td rowspan="2">X6S</td> <td>6.3V, 10V</td> <td>C>0.1µF</td> </tr> <tr> <td>16V, 25V</td> <td>C≥0.1µF</td> </tr> <tr> <td rowspan="2">X7R/X7S/Y5V</td> <td>25V</td> <td>C≥0.1µF</td> </tr> <tr> <td>35V</td> <td>C≥0.1µF</td> </tr> <tr> <td rowspan="3">0603</td> <td rowspan="2">X5R/X7R/X6S/X7S</td> <td>4V</td> <td>C≥22µF</td> </tr> <tr> <td>6.3V, 10V</td> <td>C≥4.7µF</td> </tr> <tr> <td>X5R/X7R/X6S</td> <td>25V</td> <td>C≥0.1µF</td> </tr> <tr> <td></td> <td>X7R</td> <td>35V</td> <td>C≥0.1µF</td> </tr> <tr> <td rowspan="4">0805</td> <td rowspan="3">X5R/X7R/X6S/X7S</td> <td>4V</td> <td>C≥47µF</td> </tr> <tr> <td>6.3V</td> <td>C≥22µF</td> </tr> <tr> <td>10V, 50V</td> <td>C≥10µF</td> </tr> <tr> <td>X7R/X6S</td> <td>16V, 25V</td> <td>C≥10µF</td> </tr> <tr> <td></td> <td>X5R</td> <td></td> <td>C≥22µF</td> </tr> <tr> <td>1206</td> <td>X5R/X7R/X6S</td> <td>≤6.3V</td> <td>C≥47µF</td> </tr> <tr> <td rowspan="2">1210</td> <td rowspan="2">X5R/X7R/X6S</td> <td>16V</td> <td>C≥47µF</td> </tr> <tr> <td>X7R</td> <td>100V</td> <td>C≥43.3µF</td> </tr> </tbody> </table>	SIZE	DIELECTRIC	RATED VOLTAGE	CAPACITANCE	0201	X5R/X7R/X6S	≤10V	C≥0.1µF	≥16V	C>0.1µF	0402	X5R	≤16V	C>0.1µF	25V, 50V	C≥0.1µF	X6S	6.3V, 10V	C>0.1µF	16V, 25V	C≥0.1µF	X7R/X7S/Y5V	25V	C≥0.1µF	35V	C≥0.1µF	0603	X5R/X7R/X6S/X7S	4V	C≥22µF	6.3V, 10V	C≥4.7µF	X5R/X7R/X6S	25V	C≥0.1µF		X7R	35V	C≥0.1µF	0805	X5R/X7R/X6S/X7S	4V	C≥47µF	6.3V	C≥22µF	10V, 50V	C≥10µF	X7R/X6S	16V, 25V	C≥10µF		X5R		C≥22µF	1206	X5R/X7R/X6S	≤6.3V	C≥47µF	1210	X5R/X7R/X6S	16V	C≥47µF	X7R	100V	C≥43.3µF	X7R, X5R, X6S, X7S: <table border="1"> <thead> <tr> <th>RATED VOLTAGE</th> <th>D.F.</th> <th colspan="2">EXCEPTIONS OF D.F. ≤</th> </tr> </thead> <tbody> <tr> <td rowspan="3">≥100V</td> <td rowspan="3">≤3%</td> <td>≤6%</td> <td>1206≥0.47µF</td> </tr> <tr> <td>≤7.5%</td> <td>0603≥0.068µF; 0805>0.1µF; 1206≥1µF; 1210≥2.2µF</td> </tr> <tr> <td>≤20%</td> <td>0805>2.2µF; 1210≤3.3µF</td> </tr> <tr> <td rowspan="2">50V</td> <td rowspan="2">≤3%</td> <td>≤6%</td> <td>0201(50V); 0603>0.047µF; 0805≥0.18µF; 1206≥0.47µF</td> </tr> <tr> <td>≤10%</td> <td>0201≥0.01µF; 1210≥3.3µF</td> </tr> <tr> <td rowspan="2">35V</td> <td rowspan="2">≤5%</td> <td>≤20%</td> <td>0402≥0.012µF; 0603>0.1µF; 0805≥1.0µF (0805/X7R>0.47µF); 1206≥2.2µF; 1210≥10µF</td> </tr> <tr> <td>≤20%</td> <td>0603≥1.0µF; 0805≥2.2µF; 1206≥2.2µF; 1210≥10µF</td> </tr> <tr> <td rowspan="3">25V</td> <td rowspan="3">≤5%</td> <td>≤10%</td> <td>0201=0.01µF; 0805≥1.0µF; 1210≥10µF</td> </tr> <tr> <td>≤14%</td> <td>0603≥0.33µF</td> </tr> <tr> <td>≤15%</td> <td>0201>0.01µF; 0402>0.10µF (0402/X7R≥0.056µF); 0603>0.47µF; 0805≥2.2µF; 1206≥0.47µF; 1210≥22µF (1210/X5R≥10µF)</td> </tr> <tr> <td rowspan="2">16V</td> <td rowspan="2">≤5%</td> <td>≤10%</td> <td>0603≥0.15µF; 0805≥0.68µF; 1206≥2.2µF; 1210≥4.7µF</td> </tr> <tr> <td>≤15%</td> <td>0201≥0.01µF (0201/X7R≥0.022µF); 0402≥0.033µF 0603>0.47µF; 0805≥2.2µF; 1206≥4.7µF; 1210≥22µF</td> </tr> <tr> <td rowspan="2">10V</td> <td rowspan="2">≤7.5%</td> <td>≤15%</td> <td>0201≥0.012µF; 0402≥0.22µF; 0603≥0.33µF; 0805≥2.2µF; 1206≥2.2µF; 1210≥22µF</td> </tr> <tr> <td>≤20%</td> <td>0201≥0.01µF; 0402≥1.0µF; 0603/X5R≥10µF; 01R5/x5R</td> </tr> <tr> <td>6.3V</td> <td>≤15%</td> <td>≤30%</td> <td>0201≥0.01µF; 0402≥1.0µF (0402/X6S≥0.47µF); 0603≥10µF; 0805≥4.7µF; 1206≥47µF; 1210≥100µF</td> </tr> <tr> <td>4V</td> <td>≤20%</td> <td>-</td> <td>-</td> </tr> </tbody> </table>	RATED VOLTAGE	D.F.	EXCEPTIONS OF D.F. ≤		≥100V	≤3%	≤6%	1206≥0.47µF	≤7.5%	0603≥0.068µF; 0805>0.1µF; 1206≥1µF; 1210≥2.2µF	≤20%	0805>2.2µF; 1210≤3.3µF	50V	≤3%	≤6%	0201(50V); 0603>0.047µF; 0805≥0.18µF; 1206≥0.47µF	≤10%	0201≥0.01µF; 1210≥3.3µF	35V	≤5%	≤20%	0402≥0.012µF; 0603>0.1µF; 0805≥1.0µF (0805/X7R>0.47µF); 1206≥2.2µF; 1210≥10µF	≤20%	0603≥1.0µF; 0805≥2.2µF; 1206≥2.2µF; 1210≥10µF	25V	≤5%	≤10%	0201=0.01µF; 0805≥1.0µF; 1210≥10µF	≤14%	0603≥0.33µF	≤15%	0201>0.01µF; 0402>0.10µF (0402/X7R≥0.056µF); 0603>0.47µF; 0805≥2.2µF; 1206≥0.47µF; 1210≥22µF (1210/X5R≥10µF)	16V	≤5%	≤10%	0603≥0.15µF; 0805≥0.68µF; 1206≥2.2µF; 1210≥4.7µF	≤15%	0201≥0.01µF (0201/X7R≥0.022µF); 0402≥0.033µF 0603>0.47µF; 0805≥2.2µF; 1206≥4.7µF; 1210≥22µF	10V	≤7.5%	≤15%	0201≥0.012µF; 0402≥0.22µF; 0603≥0.33µF; 0805≥2.2µF; 1206≥2.2µF; 1210≥22µF	≤20%	0201≥0.01µF; 0402≥1.0µF; 0603/X5R≥10µF; 01R5/x5R	6.3V	≤15%	≤30%	0201≥0.01µF; 0402≥1.0µF (0402/X6S≥0.47µF); 0603≥10µF; 0805≥4.7µF; 1206≥47µF; 1210≥100µF	4V	≤20%	-	-
		SIZE	DIELECTRIC	RATED VOLTAGE	CAPACITANCE																																																																																																																			
		0201	X5R/X7R/X6S	≤10V	C≥0.1µF																																																																																																																			
				≥16V	C>0.1µF																																																																																																																			
		0402	X5R	≤16V	C>0.1µF																																																																																																																			
				25V, 50V	C≥0.1µF																																																																																																																			
			X6S	6.3V, 10V	C>0.1µF																																																																																																																			
				16V, 25V	C≥0.1µF																																																																																																																			
			X7R/X7S/Y5V	25V	C≥0.1µF																																																																																																																			
				35V	C≥0.1µF																																																																																																																			
		0603	X5R/X7R/X6S/X7S	4V	C≥22µF																																																																																																																			
				6.3V, 10V	C≥4.7µF																																																																																																																			
			X5R/X7R/X6S	25V	C≥0.1µF																																																																																																																			
			X7R	35V	C≥0.1µF																																																																																																																			
		0805	X5R/X7R/X6S/X7S	4V	C≥47µF																																																																																																																			
				6.3V	C≥22µF																																																																																																																			
				10V, 50V	C≥10µF																																																																																																																			
X7R/X6S	16V, 25V		C≥10µF																																																																																																																					
	X5R		C≥22µF																																																																																																																					
1206	X5R/X7R/X6S	≤6.3V	C≥47µF																																																																																																																					
1210	X5R/X7R/X6S	16V	C≥47µF																																																																																																																					
		X7R	100V	C≥43.3µF																																																																																																																				
RATED VOLTAGE	D.F.	EXCEPTIONS OF D.F. ≤																																																																																																																						
≥100V	≤3%	≤6%	1206≥0.47µF																																																																																																																					
		≤7.5%	0603≥0.068µF; 0805>0.1µF; 1206≥1µF; 1210≥2.2µF																																																																																																																					
		≤20%	0805>2.2µF; 1210≤3.3µF																																																																																																																					
50V	≤3%	≤6%	0201(50V); 0603>0.047µF; 0805≥0.18µF; 1206≥0.47µF																																																																																																																					
		≤10%	0201≥0.01µF; 1210≥3.3µF																																																																																																																					
35V	≤5%	≤20%	0402≥0.012µF; 0603>0.1µF; 0805≥1.0µF (0805/X7R>0.47µF); 1206≥2.2µF; 1210≥10µF																																																																																																																					
		≤20%	0603≥1.0µF; 0805≥2.2µF; 1206≥2.2µF; 1210≥10µF																																																																																																																					
25V	≤5%	≤10%	0201=0.01µF; 0805≥1.0µF; 1210≥10µF																																																																																																																					
		≤14%	0603≥0.33µF																																																																																																																					
		≤15%	0201>0.01µF; 0402>0.10µF (0402/X7R≥0.056µF); 0603>0.47µF; 0805≥2.2µF; 1206≥0.47µF; 1210≥22µF (1210/X5R≥10µF)																																																																																																																					
16V	≤5%	≤10%	0603≥0.15µF; 0805≥0.68µF; 1206≥2.2µF; 1210≥4.7µF																																																																																																																					
		≤15%	0201≥0.01µF (0201/X7R≥0.022µF); 0402≥0.033µF 0603>0.47µF; 0805≥2.2µF; 1206≥4.7µF; 1210≥22µF																																																																																																																					
10V	≤7.5%	≤15%	0201≥0.012µF; 0402≥0.22µF; 0603≥0.33µF; 0805≥2.2µF; 1206≥2.2µF; 1210≥22µF																																																																																																																					
		≤20%	0201≥0.01µF; 0402≥1.0µF; 0603/X5R≥10µF; 01R5/x5R																																																																																																																					
6.3V	≤15%	≤30%	0201≥0.01µF; 0402≥1.0µF (0402/X6S≥0.47µF); 0603≥10µF; 0805≥4.7µF; 1206≥47µF; 1210≥100µF																																																																																																																					
4V	≤20%	-	-																																																																																																																					
*Any items outside this range or with a different dielectric will hold the following test conditions: (1) ≤ 6.3V or C ≥ 10µF : 150% of rated voltage. (2) 10V ≤ Vr ≤ 100V: 200% of rated voltage.																																																																																																																								

ENVIRONMENTAL CHARACTERISTICS

NO	ITEM	TEST CONDITION	REQUIREMENTS																																								
18	HIGH TEMPERATURE Load-Endurance (Life Testing)	(3) 150% of rated voltage for below range.	<ul style="list-style-type: none"> No remarkable damage. CAP CHANGE: COG: $\pm 3.0\%$ or $\pm 0.3\text{pF}$ whichever is larger X7R, X5R, X6S, X7S: $\geq 10\text{V}^{**}$, within $\pm 12.5\%$; $\leq 6.3\text{V}$ within $\pm 25\%$ **10V: 0603$\geq 4.7\mu\text{F}$; 0402$\geq 1.0\mu\text{F}$; 0201$\geq 0.1\mu\text{F}$, within $\pm 25\%$ Y5V$\geq 10\text{V}$, within $\pm 30\%$; $\leq 6.3\text{V}$, within $+30\%/-40\%$ Q/D.F. VALUE: COG: More than 30pF, Q≥ 350 10pF$\leq 30\text{pF}$, Q$\geq 275+2.5\text{C}$ Less than 10pF, Q$\geq 200+10\text{C}$ 																																								
		SIZE		DIELECTRIC	RATED VOLTAGE	CAPACITANCE																																					
		0201		X5R/X6S	16V, 25V	C $\geq 0.1\mu\text{F}$																																					
				X7R	16V	C $\geq 0.022\mu\text{F}$																																					
		0402		X7R/X5R/X6S	50V	C $\geq 0.01\mu\text{F}$																																					
					10-25V	C $\geq 0.22\mu\text{F}$																																					
				Y5V	16V	C $\geq 0.47\mu\text{F}$																																					
		0603		X7S	50-100V	C $> 0.22\mu\text{F}$																																					
					50V	C $> 0.1\mu\text{F}$																																					
				X7R	25V	C=1.0 μF																																					
				X5R	50V	C $\geq 1.0\mu\text{F}$																																					
				X5R/X7R/ X6S/X7S	10V, 16V	C $\geq 1.0\mu\text{F}$																																					
		0805		X5R/X7R/ X6S/X7S	100V	C $\geq 0.47\mu\text{F}$																																					
					50V	C $\geq 0.68\mu\text{F}$																																					
					35V	C $\geq 2.2\mu\text{F}$																																					
					10-25V	C $\geq 4.7\mu\text{F}$																																					
		1206		X7R	100V	C $\geq 1.0\mu\text{F}$																																					
					50V	C=4.7 μF																																					
1210	X5R/X6S/X7S	100V	C $> 1.0\mu\text{F}$																																								
		50V	C=4.7 μF																																								
1825 2220 2225	X7R	100-250V	C $\geq 1.0\mu\text{F}$																																								
<p>* Before initial measurement (Class II only): To apply de-aging at 150 °C for 1 hr then set for 24\pm2 hrs at room temp</p> <p>* Cap./DF(Q)/I.R. Measurement to be made after de-aging at 150 °C for 1hr then set for 24\pm2hrs at room temp.</p> <p>** De-rating conditions:</p>			<p>Y5V:</p> <table border="1"> <thead> <tr> <th>RATED VOLTAGE</th> <th>D.F.</th> <th colspan="2">EXCEPTIONS OF D.F. \leq</th> </tr> </thead> <tbody> <tr> <td>$\geq 0\text{V}$</td> <td>$\leq 7.5\%$</td> <td>$\leq 10\%$</td> <td>0603$\geq 0.1\mu\text{F}$; 0805$\geq 0.47\mu\text{F}$; 1206$\geq 4.7\mu\text{F}$</td> </tr> <tr> <td></td> <td></td> <td>$\leq 20\%$</td> <td>1210$\geq 6.8\mu\text{F}$</td> </tr> <tr> <td>35V</td> <td>$\leq 10\%$</td> <td>-</td> <td>-</td> </tr> <tr> <td rowspan="2">25V</td> <td rowspan="2">$\leq 7.5\%$</td> <td>$\leq 10\%$</td> <td>0402$\geq 0.047\mu\text{F}$; 0603$\geq 0.1\mu\text{F}$; 0805$\geq 0.33\mu\text{F}$; 1206$\geq 1.0\mu\text{F}$; 1210$\geq 4.7\mu\text{F}$</td> </tr> <tr> <td>$\leq 15\%$</td> <td>0402$\geq 0.068\mu\text{F}$; 0603$\geq 0.47\mu\text{F}$; 1206$\geq 4.7\mu\text{F}$; 1210$\geq 22\mu\text{F}$</td> </tr> <tr> <td rowspan="2">16V (C$< 1.0\mu\text{F}$)</td> <td rowspan="2">$\leq 10\%$</td> <td>$\leq 12.5\%$</td> <td>0402$\geq 0.068\mu\text{F}$; 0603$\geq 0.68\mu\text{F}$</td> </tr> <tr> <td>$\leq 20\%$</td> <td>0402$\geq 0.22\mu\text{F}$</td> </tr> <tr> <td>16V (C$\geq 1.0\mu\text{F}$)</td> <td>$\leq 12.5\%$</td> <td>$\leq 20\%$</td> <td>0603$\geq 2.2\mu\text{F}$; 0805$\geq 3.3\mu\text{F}$; 1206$\geq 10\mu\text{F}$; 1210$\geq 22\mu\text{F}$; 1812$\geq 47\mu\text{F}$</td> </tr> <tr> <td>10V</td> <td>$\leq 20\%$</td> <td>$\leq 30\%$</td> <td>0402$\geq 0.47\mu\text{F}$</td> </tr> <tr> <td>6.3V</td> <td>$\leq 30\%$</td> <td>-</td> <td>-</td> </tr> </tbody> </table>	RATED VOLTAGE	D.F.	EXCEPTIONS OF D.F. \leq		$\geq 0\text{V}$	$\leq 7.5\%$	$\leq 10\%$	0603 $\geq 0.1\mu\text{F}$; 0805 $\geq 0.47\mu\text{F}$; 1206 $\geq 4.7\mu\text{F}$			$\leq 20\%$	1210 $\geq 6.8\mu\text{F}$	35V	$\leq 10\%$	-	-	25V	$\leq 7.5\%$	$\leq 10\%$	0402 $\geq 0.047\mu\text{F}$; 0603 $\geq 0.1\mu\text{F}$; 0805 $\geq 0.33\mu\text{F}$; 1206 $\geq 1.0\mu\text{F}$; 1210 $\geq 4.7\mu\text{F}$	$\leq 15\%$	0402 $\geq 0.068\mu\text{F}$; 0603 $\geq 0.47\mu\text{F}$; 1206 $\geq 4.7\mu\text{F}$; 1210 $\geq 22\mu\text{F}$	16V (C $< 1.0\mu\text{F}$)	$\leq 10\%$	$\leq 12.5\%$	0402 $\geq 0.068\mu\text{F}$; 0603 $\geq 0.68\mu\text{F}$	$\leq 20\%$	0402 $\geq 0.22\mu\text{F}$	16V (C $\geq 1.0\mu\text{F}$)	$\leq 12.5\%$	$\leq 20\%$	0603 $\geq 2.2\mu\text{F}$; 0805 $\geq 3.3\mu\text{F}$; 1206 $\geq 10\mu\text{F}$; 1210 $\geq 22\mu\text{F}$; 1812 $\geq 47\mu\text{F}$	10V	$\leq 20\%$	$\leq 30\%$	0402 $\geq 0.47\mu\text{F}$	6.3V	$\leq 30\%$	-	-
RATED VOLTAGE	D.F.	EXCEPTIONS OF D.F. \leq																																									
$\geq 0\text{V}$	$\leq 7.5\%$	$\leq 10\%$	0603 $\geq 0.1\mu\text{F}$; 0805 $\geq 0.47\mu\text{F}$; 1206 $\geq 4.7\mu\text{F}$																																								
		$\leq 20\%$	1210 $\geq 6.8\mu\text{F}$																																								
35V	$\leq 10\%$	-	-																																								
25V	$\leq 7.5\%$	$\leq 10\%$	0402 $\geq 0.047\mu\text{F}$; 0603 $\geq 0.1\mu\text{F}$; 0805 $\geq 0.33\mu\text{F}$; 1206 $\geq 1.0\mu\text{F}$; 1210 $\geq 4.7\mu\text{F}$																																								
		$\leq 15\%$	0402 $\geq 0.068\mu\text{F}$; 0603 $\geq 0.47\mu\text{F}$; 1206 $\geq 4.7\mu\text{F}$; 1210 $\geq 22\mu\text{F}$																																								
16V (C $< 1.0\mu\text{F}$)	$\leq 10\%$	$\leq 12.5\%$	0402 $\geq 0.068\mu\text{F}$; 0603 $\geq 0.68\mu\text{F}$																																								
		$\leq 20\%$	0402 $\geq 0.22\mu\text{F}$																																								
16V (C $\geq 1.0\mu\text{F}$)	$\leq 12.5\%$	$\leq 20\%$	0603 $\geq 2.2\mu\text{F}$; 0805 $\geq 3.3\mu\text{F}$; 1206 $\geq 10\mu\text{F}$; 1210 $\geq 22\mu\text{F}$; 1812 $\geq 47\mu\text{F}$																																								
10V	$\leq 20\%$	$\leq 30\%$	0402 $\geq 0.47\mu\text{F}$																																								
6.3V	$\leq 30\%$	-	-																																								
<p>*I.R.: $\geq 10\text{V}$, 1GΩ or 50Q-F whichever is smaller. Class II (X7R, X5R, X6S, X7S, Y5V)</p>			<table border="1"> <thead> <tr> <th>RATED VOLTAGE</th> <th>INSULATION RESISTANCE</th> </tr> </thead> <tbody> <tr> <td>100V: All X7R; 1210$\geq 3.3\mu\text{F}$</td> <td rowspan="7">1GΩ or apply $\geq 10\Omega\text{-F}$ rule, whichever is smaller.</td> </tr> <tr> <td>50V: 0402$> 0.01\mu\text{F}$; 0603$\geq 1.0\mu\text{F}$; 0805$\geq 1.0\mu\text{F}$; 1206$\geq 4.7\mu\text{F}$; 1210$\geq 4.7\mu\text{F}$</td> </tr> <tr> <td>35V: 0603$\geq 1.0\mu\text{F}$; 0805$\geq 2.2\mu\text{F}$; 1206$\geq 2.2\mu\text{F}$; 1210$\geq 10\mu\text{F}$</td> </tr> <tr> <td>25V: 0201$\geq 0.1\mu\text{F}$; 0402$\geq 0.22\mu\text{F}$; 0603$\geq 2.2\mu\text{F}$; 0805$\geq 2.2\mu\text{F}$; 1206$\geq 10\mu\text{F}$; 1210$\geq 10\mu\text{F}$</td> </tr> <tr> <td>16V: 0201$\geq 0.1\mu\text{F}$; 0402$\geq 0.22\mu\text{F}$; 0603$\geq 1.0\mu\text{F}$; 0805$\geq 2.2\mu\text{F}$; 1206$\geq 10\mu\text{F}$; 1210$\geq 47\mu\text{F}$</td> </tr> <tr> <td>10V: 0201$\geq 47\text{nF}$; 0402$\geq 0.47\mu\text{F}$; 0603$\geq 0.47\mu\text{F}$; 0805$\geq 2.2\mu\text{F}$; 1206$\geq 4.7\mu\text{F}$; 1210$\geq 47\mu\text{F}$</td> </tr> <tr> <td>6.3V; 4V : All X6S/X7S items, Size≥ 1812</td> </tr> </tbody> </table>	RATED VOLTAGE	INSULATION RESISTANCE	100V: All X7R; 1210 $\geq 3.3\mu\text{F}$	1G Ω or apply $\geq 10\Omega\text{-F}$ rule, whichever is smaller.	50V: 0402 $> 0.01\mu\text{F}$; 0603 $\geq 1.0\mu\text{F}$; 0805 $\geq 1.0\mu\text{F}$; 1206 $\geq 4.7\mu\text{F}$; 1210 $\geq 4.7\mu\text{F}$	35V: 0603 $\geq 1.0\mu\text{F}$; 0805 $\geq 2.2\mu\text{F}$; 1206 $\geq 2.2\mu\text{F}$; 1210 $\geq 10\mu\text{F}$	25V: 0201 $\geq 0.1\mu\text{F}$; 0402 $\geq 0.22\mu\text{F}$; 0603 $\geq 2.2\mu\text{F}$; 0805 $\geq 2.2\mu\text{F}$; 1206 $\geq 10\mu\text{F}$; 1210 $\geq 10\mu\text{F}$	16V: 0201 $\geq 0.1\mu\text{F}$; 0402 $\geq 0.22\mu\text{F}$; 0603 $\geq 1.0\mu\text{F}$; 0805 $\geq 2.2\mu\text{F}$; 1206 $\geq 10\mu\text{F}$; 1210 $\geq 47\mu\text{F}$	10V: 0201 $\geq 47\text{nF}$; 0402 $\geq 0.47\mu\text{F}$; 0603 $\geq 0.47\mu\text{F}$; 0805 $\geq 2.2\mu\text{F}$; 1206 $\geq 4.7\mu\text{F}$; 1210 $\geq 47\mu\text{F}$	6.3V; 4V : All X6S/X7S items, Size ≥ 1812																														
RATED VOLTAGE	INSULATION RESISTANCE																																										
100V: All X7R; 1210 $\geq 3.3\mu\text{F}$	1G Ω or apply $\geq 10\Omega\text{-F}$ rule, whichever is smaller.																																										
50V: 0402 $> 0.01\mu\text{F}$; 0603 $\geq 1.0\mu\text{F}$; 0805 $\geq 1.0\mu\text{F}$; 1206 $\geq 4.7\mu\text{F}$; 1210 $\geq 4.7\mu\text{F}$																																											
35V: 0603 $\geq 1.0\mu\text{F}$; 0805 $\geq 2.2\mu\text{F}$; 1206 $\geq 2.2\mu\text{F}$; 1210 $\geq 10\mu\text{F}$																																											
25V: 0201 $\geq 0.1\mu\text{F}$; 0402 $\geq 0.22\mu\text{F}$; 0603 $\geq 2.2\mu\text{F}$; 0805 $\geq 2.2\mu\text{F}$; 1206 $\geq 10\mu\text{F}$; 1210 $\geq 10\mu\text{F}$																																											
16V: 0201 $\geq 0.1\mu\text{F}$; 0402 $\geq 0.22\mu\text{F}$; 0603 $\geq 1.0\mu\text{F}$; 0805 $\geq 2.2\mu\text{F}$; 1206 $\geq 10\mu\text{F}$; 1210 $\geq 47\mu\text{F}$																																											
10V: 0201 $\geq 47\text{nF}$; 0402 $\geq 0.47\mu\text{F}$; 0603 $\geq 0.47\mu\text{F}$; 0805 $\geq 2.2\mu\text{F}$; 1206 $\geq 4.7\mu\text{F}$; 1210 $\geq 47\mu\text{F}$																																											
6.3V; 4V : All X6S/X7S items, Size ≥ 1812																																											
<p>DERATING CURVE</p>																																											

ADHESIVE STRENGTH OF TERMINATION

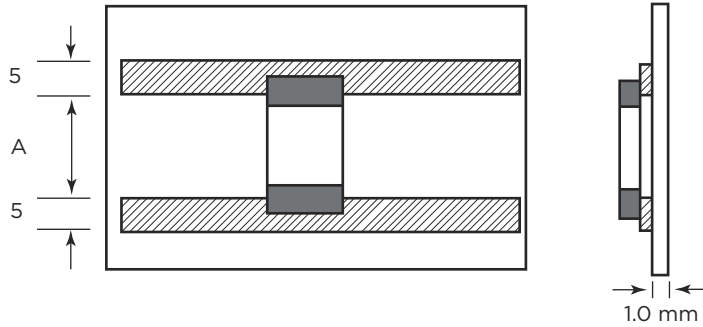

CODE	DIMENSION (mm)	A (mm)	CODE	DIMENSION (mm)	A (mm)
01005 (0402)	0.40 x 0.20	0.12	1206 (3216)	3.2 x 1.6	2.2
0201 (0603)	0.61 x 0.31	0.2	1210 (3225)	3.2 x 2.5	2.2
0402 (1005)	1.0 x 0.5	0.4	1812 (4532)	4.5 x 3.2	3.5
0603 (1608)	1.6 x 0.8	1.0	2220 (5750)	5.7 x 5.08	4.7
0805 (2012)	2.0 x 1.25	1.2			

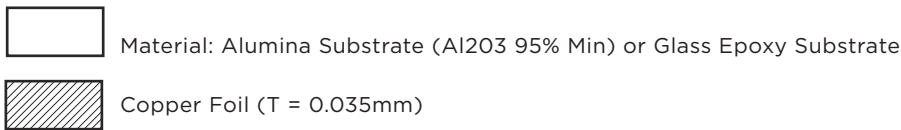

SUBSTRATE BENDING STRENGTH

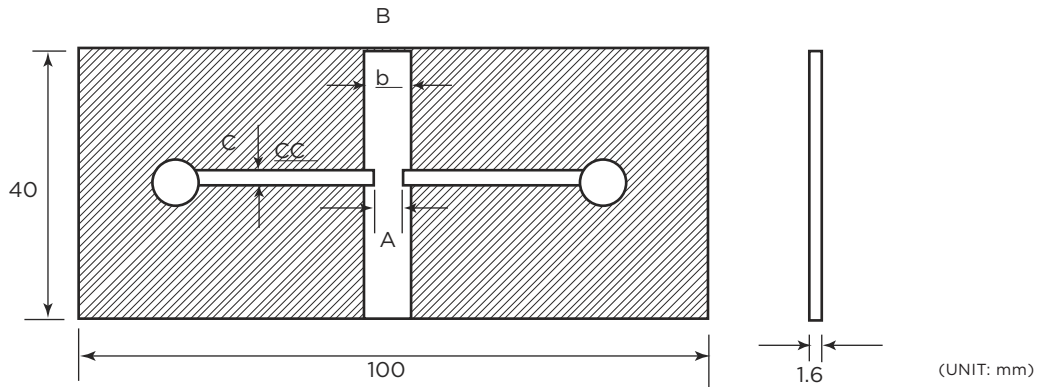

CODE	DIMENSION (mm)	A (mm)	B (mm)	C (mm)
01005 (0402)	0.40 x 0.20	0.12	0.7	0.20
0201 (0603)	0.61 x 0.31	0.2	1.0	0.4
0402 (1005)	1.0 x 0.5	0.4	1.4	0.5
0603 (1608)	1.6 x 0.8	1.0	3.0	1.0
0805 (2012)	2.0 x 1.25	1.2	4.0	1.65
1206 (3216)	3.2 x 1.6	2.2	5.0	2.0
1210 (3225)	3.2 x 2.5	2.2	5.0	3.2
1812 (4532)	4.5 x 3.2	3.5	7.0	4.0
2220 (5750)	5.7 x 5.08	4.7	8.5	5.0



TEST SUBSTRATE

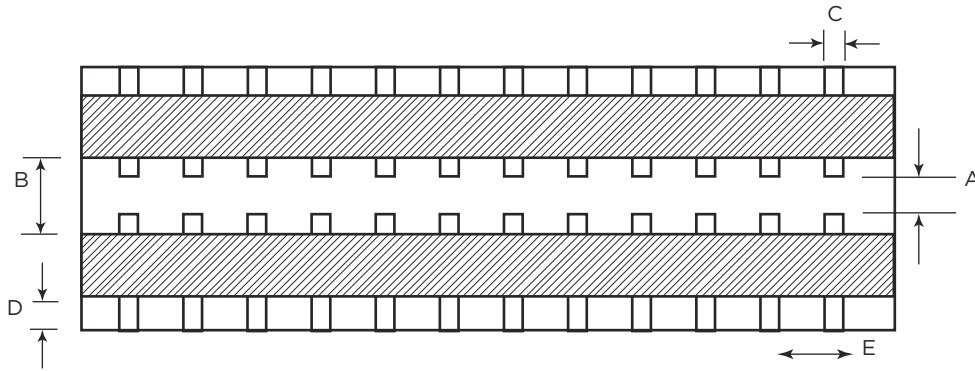

(UNIT: mm)

CODE	DIMENSION (MM)	A	B	C	D	E
0201 (0603)	0.61 x 0.31	0.2	1.0	0.4	7.5	3.6
0402 (1005)	1.0 x 0.5	0.4	1.4	0.5	7.5	3.8
0603 (1608)	1.6 x 0.8	1.0	3.0	0.7	7.5	4.0
0805 (2012)	2.0 x 1.25	1.2	4.0	1.0	7.5	4.2
1206 (3216)	3.2 x 1.6	2.2	5.0	1.3	7.5	4.6
1210 (3225)	3.2 x 2.5	2.2	5.0	2.0	7.5	5.5
1812 (4532)	4.5 x 3.2	3.5	7.0	2.7	7.5	6.2
2220 (5750)	5.7 x 5.08	4.7	8.5	3.4	7.5	7.0

MATERIAL: GLASS EPOXY SUBSTRATE



COPPER FOIL (t = 0.035mm)



SOLDER RESIST

Looking for pricing, stock, or lifecycle information?

Click below to explore more details on WIN SOURCE:

 [View C1206X7R100-475KNE on WIN SOURCE](#)

 [Venkel Information](#)

Optimize Your Supply Chain with WIN SOURCE Solutions

-  Global Sourcing Solution
-  Obsolete Management
-  Cost Control Management
-  Shortage Management
-  Alternative Solution
-  Excess Inventory Management