



**THE DATASHEET OF  
BZX84C4V3S-7-F**



## Features

- Planar Die Construction
- 200mW Power Dissipation
- Zener Voltages from 2.4V - 39V
- Ultra-Small Surface Mount Package
- **Lead Free/RoHS Compliant (Note 2)**
- **"Green" Device (Note 3 and 4)**

## Mechanical Data

- Case: SOT-363
- Case Material: Molded Plastic. UL Flammability Classification Rating 94V-0
- Moisture Sensitivity: Level 1 per J-STD-020D
- Terminals: Solderable per MIL-STD-202, Method 208
- Lead Free Plating (Matte Tin Finish annealed over Alloy 42 leadframe).
- Polarity: See Diagram
- Marking Information: See Page 3
- Ordering Information: See Page 3
- Weight: 0.006 grams (approximate)



Top View



Device Schematic

## Maximum Ratings @ $T_A = 25^\circ\text{C}$ unless otherwise specified

Characteristic	Symbol	Value	Unit
Forward Voltage @ $I_F = 10\text{mA}$	$V_F$	0.9	V

## Thermal Characteristics

Characteristic	Symbol	Value	Unit
Power Dissipation (Note 1)	$P_D$	200	mW
Thermal Resistance, Junction to Ambient Air (Note 1)	$R_{\theta JA}$	625	$^\circ\text{C/W}$
Operating and Storage Temperature Range	$T_J, T_{STG}$	-65 to +150	$^\circ\text{C}$

- Notes:
1. Mounted on FR4 PC Board with recommended pad layout which can be found on our website at <http://www.diodes.com/datasheets/ap02001.pdf>.
  2. No purposefully added lead.
  3. Diodes Inc.'s "Green" policy can be found on our website at [http://www.diodes.com/products/lead\\_free/index.php](http://www.diodes.com/products/lead_free/index.php).
  4. Product manufactured with Date Code UO (week 40, 2007) and newer are built with Green Molding Compound. Product manufactured prior to Date Code UO are built with Non-Green Molding Compound and may contain Halogens or Sb2O3 Fire Retardants.

**Electrical Characteristics** @ $T_A = 25^\circ\text{C}$  unless otherwise specified

Type Number	Marking Code	Zener Voltage Range (Note 5)				Maximum Zener Impedance (Note 6)			Maximum Reverse Current (Note 5)		Temperature Coefficient of Zener Voltage @ $I_{ZT} = 5\text{mA}$ mV/°C	
		$V_Z @ I_{ZT}$			$I_{ZT}$	$Z_{ZT} @ I_{ZT}$	$Z_{ZK} @ I_{ZK}$	$I_{ZK}$	$I_R$	$V_R$	Min	Max
		Nom (V)	Min (V)	Max (V)	mA	$\Omega$	$\Omega$	mA	$\mu\text{A}$	V		
BZX84C2V4S	KZB	2.4	2.2	2.6	5.0	100	600	1.0	50	1.0	-3.5	0
BZX84C2V7S	KZC	2.7	2.5	2.9	5.0	100	600	1.0	20	1.0	-3.5	0
BZX84C3V0S	KZD	3.0	2.8	3.2	5.0	95	600	1.0	10	1.0	-3.5	0
BZX84C3V3S	KZE	3.3	3.1	3.5	5.0	95	600	1.0	5.0	1.0	-3.5	0
BZX84C3V6S	KZF	3.6	3.4	3.8	5.0	90	600	1.0	5.0	1.0	-3.5	0
BZX84C3V9S	KZG	3.9	3.7	4.1	5.0	90	600	1.0	3.0	1.0	-3.5	0
BZX84C4V3S	KZH	4.3	4.0	4.6	5.0	90	600	1.0	3.0	1.0	-3.5	0
BZX84C4V7S	KZ1	4.7	4.4	5.0	5.0	80	500	1.0	3.0	2.0	-3.5	0.2
BZX84C5V1S	KZ2	5.1	4.8	5.4	5.0	60	480	1.0	2.0	2.0	-2.7	1.2
BZX84C5V6S	KZ3	5.6	5.2	6.0	5.0	40	400	1.0	1.0	2.0	-2.0	-2.5
BZX84C6V2S	KZ4	6.2	5.8	6.6	5.0	10	150	1.0	3.0	4.0	0.4	3.7
BZX84C6V8S	KZ5	6.8	6.4	7.2	5.0	15	80	1.0	2.0	4.0	1.2	4.5
BZX84C7V5S	KZ6	7.5	7.0	7.9	5.0	15	80	1.0	1.0	5.0	2.5	5.3
BZX84C8V2S	KZ7	8.2	7.7	8.7	5.0	15	80	1.0	0.7	5.0	3.2	6.2
BZX84C9V1S	KZ8	9.1	8.5	9.6	5.0	15	100	1.0	0.5	6.0	3.8	7.0
BZX84C10S	KZ9	10	9.4	10.6	5.0	20	150	1.0	0.2	7.0	4.5	8.0
BZX84C11S	KY1	11	10.4	11.6	5.0	20	150	1.0	0.1	8.0	5.4	9.0
BZX84C12S	KY2	12	11.4	12.7	5.0	25	150	1.0	0.1	8.0	6.0	10.0
BZX84C13S	KY3	13	12.4	14.1	5.0	30	170	1.0	0.1	8.0	7.0	11.0
BZX84C15S	KY4	15	13.8	15.6	5.0	30	200	1.0	0.1	10.5	9.2	13.0
BZX84C16S	KY5	16	15.3	17.1	5.0	40	200	1.0	0.1	11.2	10.4	14.0
BZX84C18S	KY6	18	16.8	19.1	5.0	45	225	1.0	0.1	12.6	12.4	16.0
BZX84C20S	KY7	20	18.8	21.2	5.0	55	225	1.0	0.1	14.0	14.4	18.0
BZX84C22S	KY8	22	20.8	23.3	5.0	55	250	1.0	0.1	15.4	16.4	20.0
BZX84C24S	KY9	24	22.8	25.6	5.0	70	250	1.0	0.1	16.8	18.4	22.0
BZX84C27S	KYA	27	25.1	28.9	2.0	80	300	0.5	0.1	18.9	21.4	25.3
BZX84C30S	KYB	30	28.0	32.0	2.0	80	300	0.5	0.1	21.0	24.4	29.4
BZX84C33S	KYC	33	31.0	35.0	2.0	80	325	0.5	0.1	23.1	27.4	33.4
BZX84C36S	KYD	36	34.0	38.0	2.0	90	350	0.5	0.1	25.2	30.4	37.4
BZX84C39S	KYE	39	37.0	41.0	2.0	130	350	0.5	0.1	27.3	33.4	41.2

Notes: 5. Short duration pulse test used to minimize self-heating effect.  
6.  $f = 1\text{KHz}$ .



Fig. 1 Power Derating Curve



Fig. 2 Typical Zener Breakdown Characteristics



Fig. 3 Typical Zener Breakdown Characteristics



Fig. 4 Typical Total Capacitance vs. Nominal Zener Voltage

**Ordering Information** (Note 7)

Part Number	Case	Packaging
(Type Number)-7-F*	SOT-363	3000/Tape & Reel

\*Add "-7-F" to the appropriate type number in Electrical Characteristics Table from Page 2 example: 6.2V Zener = BZX84C6V2S-7-F.

Notes: 7. For packaging details, go to our website at <http://www.diodes.com/datasheets/ap02007.pdf>.

**Marking Information**



Kxx = Product Type Marking Code  
(See Electrical Characteristics Table)  
YM = Date Code Marking  
Y = Year (ex: N = 2002)  
M = Month (ex: 9 = September)

Date Code Key

Year	2002	2003	2004	2005	2006	2007	2008	2009	2010	2111	2012
Code	N	P	R	S	T	U	V	W	X	Y	Z

Month	Jan	Feb	Mar	Apr	May	Jun	Jul	Aug	Sep	Oct	Nov	Dec
Code	1	2	3	4	5	6	7	8	9	O	N	D

**Package Outline Dimensions**

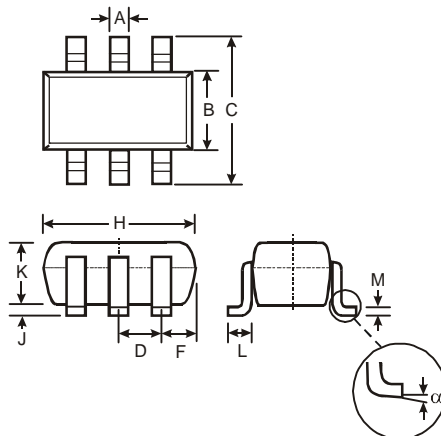

SOT-363		
Dim	Min	Max
A	0.10	0.30
B	1.15	1.35
C	2.00	2.20
D	0.65 Nominal	
F	0.30	0.40
H	1.80	2.20
J	—	0.10
K	0.90	1.00
L	0.25	0.40
M	0.10	0.25
α	0°	8°
All Dimensions in mm		

**Suggested Pad Layout**

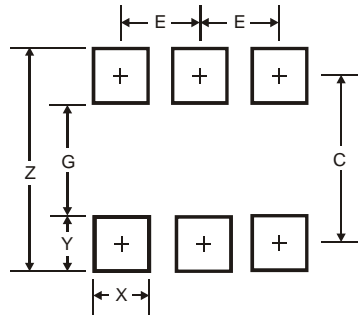

Dimensions	Value (in mm)
Z	2.5
G	1.3
X	0.42
Y	0.6
C	1.9
E	0.65

**IMPORTANT NOTICE**



Diodes Incorporated and its subsidiaries reserve the right to make modifications, enhancements, improvements, corrections or other changes without further notice to any product herein. Diodes Incorporated does not assume any liability arising out of the application or use of any product described herein; neither does it convey any license under its patent rights, nor the rights of others. The user of products in such applications shall assume all risks of such use and will agree to hold Diodes Incorporated and all the companies whose products are represented on our website, harmless against all damages.

**LIFE SUPPORT**

Diodes Incorporated products are not authorized for use as critical components in life support devices or systems without the expressed written approval of the President of Diodes Incorporated.

## Looking for pricing, stock, or lifecycle information?

Click below to explore more details on WIN SOURCE:

-  [View BZX84C4V3S-7-F on WIN SOURCE](#)
-  [Diodes Incorporated Information](#)

## Optimize Your Supply Chain with WIN SOURCE Solutions

-  Global Sourcing Solution
-  Obsolete Management
-  Cost Control Management
-  Shortage Management
-  Alternative Solution
-  Excess Inventory Management