



**THE DATASHEET OF  
BZT52-B3V9S-AU\_R1\_000A1**



# BZT52-B2V4S-AU SERIES

## Surface Mount Silicon Zener Diodes

**VOLTAGE** 2.4 to 75 Volt **POWER** 200 mWatt

**SOD-323** Unit : inch(mm)

### FEATURES

- Planar Die construction
- 200mW Power Dissipation
- Zener Voltages from 2.4~75V
- Ideally Suited for Automated Assembly Processes
- AEC-Q101 qualified
- Lead free in compliance with EU RoHS 2.0
- Green molding compound as per IEC 61249 standard

### MECHANICAL DATA

- Case : SOD-323, Molded Plastic
- Terminals : Solderable per MIL-STD-750, Method 2026
- Apprx. Weight : 0.0041 grams

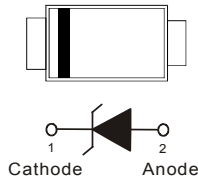
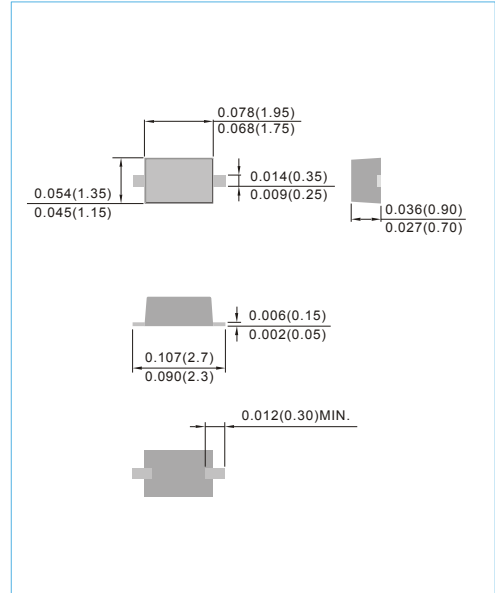

## MAXIMUM RATINGS AND ELECTRICAL CHARACTERISTICS

Parameter	Symbol	Value	Units
Power Dissipation @ $T_A=25^{\circ}\text{C}$ (Note A)	$P_D$	200	mW
Typical Thermal Resistance(Note B)	$R_{\theta JA}$	650	$^{\circ}\text{C}/\text{W}$
Operating Junction and Storage Temperature Range	$T_J$	-55 to +150	$^{\circ}\text{C}$

### NOTES :

- A. Mounted on a FR-4 PCB, single-sided copper, with 100cm<sup>2</sup> copper pad area.
- B. Mounted on a FR-4 PCB, single-sided copper, mini pad.

## BZT52-B2V4S-AU SERIES

Part Number	Nominal Zener Voltage			Max. Zener Impedance				Max Reverse Leakage Current		Marking Code
	Vz @ IzT			Zzt @ IzT		Zzk @ Izk		IR @ VR		
	Nom. V	Min. V	Max. V	Ω	mA	Ω	mA	μA	V	
200 mWatts Zener Diodes										
BZT52-B2V4S-AU	2.4	2.35	2.45	85	5.0	600	1.00	100	1.0	W1
BZT52-B2V7S-AU	2.7	2.64	2.75	83	5.0	600	1.00	75	1.0	W2
BZT52-B3S-AU	3.0	2.94	3.06	95	5.0	600	1.00	50	1.0	W3
BZT52-B3V3S-AU	3.3	3.23	3.37	95	5.0	600	1.00	25	1.0	W4
BZT52-B3V6S-AU	3.6	3.52	3.67	95	5.0	600	1.00	15	1.0	W5
BZT52-B3V9S-AU	3.9	3.82	3.98	95	5.0	600	1.00	10	1.0	W6
BZT52-B4V3S-AU	4.3	4.21	4.39	95	5.0	600	1.00	5.0	1.0	W7
BZT52-B4V7S-AU	4.7	4.61	4.79	78	5.0	500	1.00	5.0	1.0	W8
BZT52-B5V1S-AU	5.1	5.00	5.20	60	5.0	480	1.00	0.1	0.8	W9
BZT52-B5V6S-AU	5.6	5.49	5.71	40	5.0	400	1.00	0.1	1.0	WA
BZT52-B5V8S-AU	5.8	5.68	5.92	30	5.0	300	1.00	0.1	1.5	85C
BZT52-B6V2S-AU	6.2	6.08	6.32	10	5.0	150	1.00	0.1	2.0	WB
BZT52-B6V8S-AU	6.8	6.66	6.94	8	5.0	80	1.00	0.1	3.0	WC
BZT52-B7V5S-AU	7.5	7.35	7.65	7	5.0	80	1.00	0.1	5.0	WD
BZT52-B8V2S-AU	8.2	8.04	8.36	7	5.0	80	1.00	0.1	6.0	WE
BZT52-B8V7S-AU	8.7	8.53	8.87	7	5.0	100	1.00	0.1	6.5	87C
BZT52-B9V1S-AU	9.1	8.92	9.28	10	5.0	100	1.00	0.1	7.0	WF
BZT52-B10S-AU	10	9.80	10.20	15	5.0	150	1.00	0.1	7.5	WG
BZT52-B11S-AU	11	10.78	11.22	20	5.0	150	1.00	0.1	8.5	WH
BZT52-B12S-AU	12	11.76	12.24	20	5.0	150	1.00	0.1	9.0	WI
BZT52-B13S-AU	13	12.74	13.26	25	5.0	170	1.00	0.1	10.0	WK
BZT52-B14S-AU	14	13.72	14.28	25	5.0	170	1.00	0.1	10.5	WJ
BZT52-B15S-AU	15	14.70	15.30	30	5.0	200	1.00	0.1	11.0	WL
BZT52-B16S-AU	16	15.68	16.32	40	5.0	200	1.00	0.1	12.0	WM
BZT52-B17S-AU	17	16.66	17.34	40	5.0	200	1.00	0.1	13.0	17C
BZT52-B18S-AU	18	17.64	18.36	50	5.0	225	1.00	0.1	14.0	WN
BZT52-B20S-AU	20	19.60	20.40	50	5.0	225	1.00	0.1	15.0	WO
BZT52-B22S-AU	22	21.56	22.44	55	5.0	250	1.00	0.1	17.0	WP
BZT52-B24S-AU	24	23.52	24.48	80	5.0	250	1.00	0.1	18.0	WR
BZT52-B27S-AU	27	26.46	27.54	80	5.0	300	1.00	0.1	20.0	WS
BZT52-B28S-AU	28	27.44	28.56	80	5.0	300	1.00	0.1	22.0	28C
BZT52-B30S-AU	30	29.40	30.60	80	5.0	300	1.00	0.1	22.5	WT
BZT52-B33S-AU	33	32.34	33.66	80	5.0	325	1.00	0.1	25.0	WU
BZT52-B36S-AU	36	35.28	36.72	90	5.0	350	1.00	0.1	27.0	WW
BZT52-B39S-AU	39	38.22	39.78	90	5.0	350	1.00	0.1	29.0	WX
BZT52-B43S-AU	43	42.14	43.86	100	5.0	375	1.00	0.1	32.0	WY
BZT52-B47S-AU	47	46.06	47.94	100	5.0	375	1.00	0.1	35.0	WZ
BZT52-B51S-AU	51	49.98	52.02	100	5.0	400	1.00	0.1	38.0	XA
BZT52-B56S-AU	56	54.88	57.12	135	2.5	1000	1.00	0.1	42.0	X2
BZT52-B62S-AU	62	60.76	63.24	150	2.5	1000	1.00	0.1	46.0	X3
BZT52-B68S-AU	68	66.64	69.36	200	2.5	1000	1.00	0.1	51.0	X4
BZT52-B75S-AU	75	73.50	76.50	250	2.5	1000	1.00	0.1	56.0	X5

# BZT52-B2V4S-AU SERIES

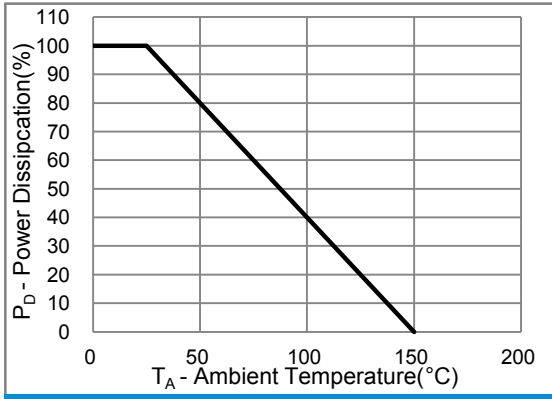

**Fig.1 Power Derating Curve**

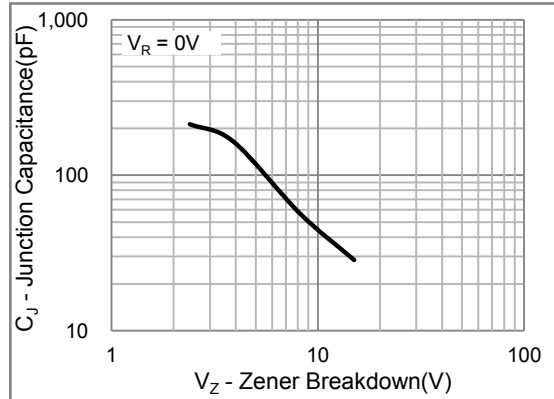

**Fig.2 Typical Junction Capacitance**

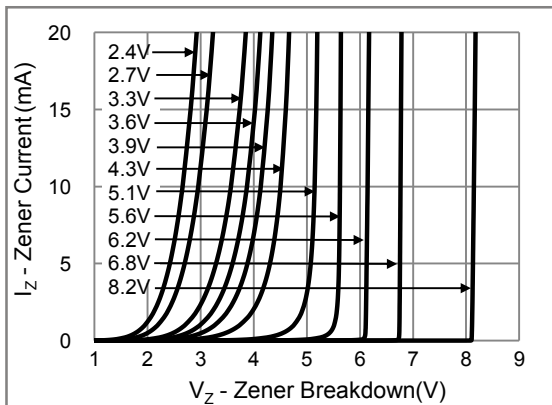

**Fig.3 Typical Zener Breakdown**

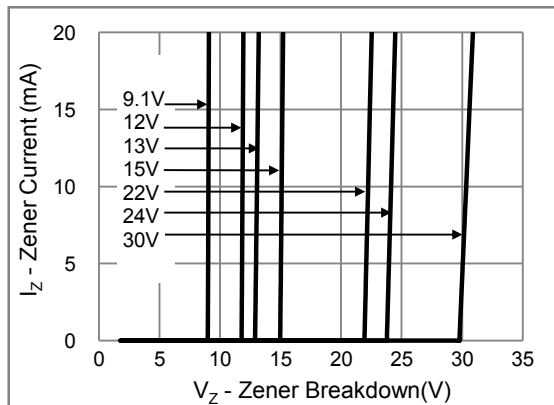

**Fig.4 Typical Zener Breakdown**

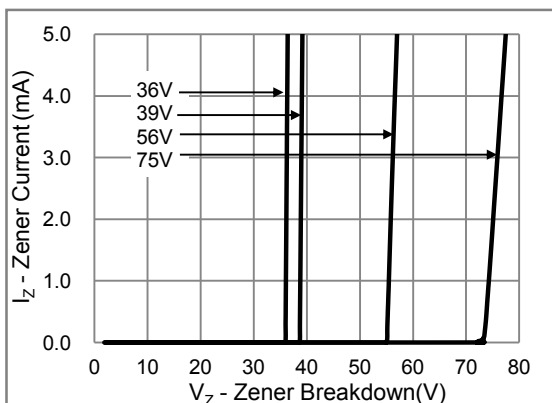

**Fig.5 Typical Zener Breakdown**

# BZT52-B2V4S-AU SERIES

## Product and Packing Information

Part No.	Package Type	Packing Type	Marking
BZT52-BxVxS-AU	SOD-323	5K pcs / 7" reel	See Table
BZT52-BxVxS-AU	SOD-323	12K pcs / 13" reel	See Table
BZT52-BxxS-AU	SOD-323	5K pcs / 7" reel	See Table
BZT52-BxxS-AU	SOD-323	12K pcs / 13" reel	See Table

## Mounting Pad Layout

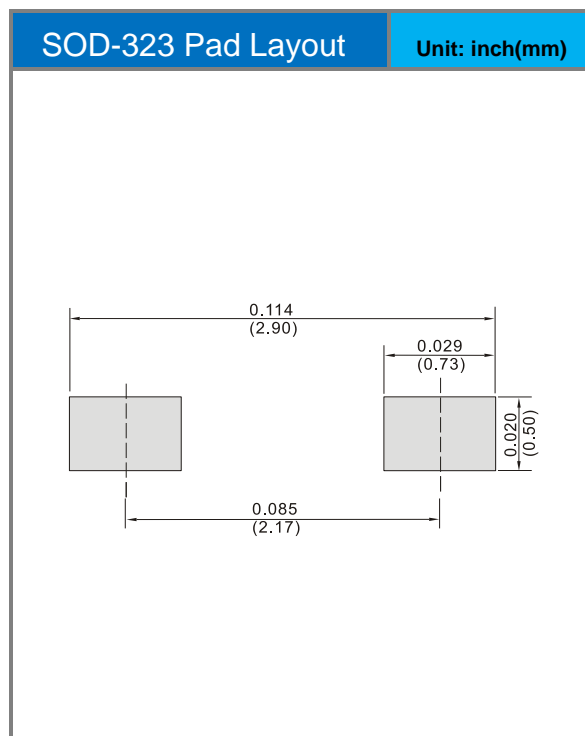

## **BZT52-B2V4S-AU SERIES**



---

### **Disclaimer**

- Reproducing and modifying information of the document is prohibited without permission from Panjit International Inc..
- Panjit International Inc. reserves the rights to make changes of the content herein the document anytime without notification. Please refer to our website for the latest document.
- Panjit International Inc. disclaims any and all liability arising out of the application or use of any product including damages incidentally and consequentially occurred.
- Panjit International Inc. does not assume any and all implied warranties, including warranties of fitness for particular purpose, non-infringement and merchantability.
- Applications shown on the herein document are examples of standard use and operation. Customers are responsible in comprehending the suitable use in particular applications. Panjit International Inc. makes no representation or warranty that such applications will be suitable for the specified use without further testing or modification.
- The products shown herein are not designed and authorized for equipments relating to human life and for any applications concerning life-saving or life-sustaining, such as medical instruments, aerospace machinery et cetera. Customers using or selling these products for use in such applications do so at their own risk and agree to fully indemnify Panjit International Inc. for any damages resulting from such improper use or sale.
- Since Panjit uses lot number as the tracking base, please provide the lot number for tracking when complaining.

## Looking for pricing, stock, or lifecycle information?

Click below to explore more details on WIN SOURCE:

-  [View BZT52-B3V9S-AU\\_R1\\_000A1 on WIN SOURCE](#)
-  [Panjit Information](#)

## Optimize Your Supply Chain with WIN SOURCE Solutions

-  Global Sourcing Solution
-  Obsolete Management
-  Cost Control Management
-  Shortage Management
-  Alternative Solution
-  Excess Inventory Management