



**THE DATASHEET OF
BWQV003225206R8K00**



BWQV Series



BWQV Series comes in 2 sizes with wide inductance range, high Q value at high frequencies and low DC resistance.

Features

- RoHS compliant
- Miniature chip inductors wound on a special ferrite core
- High Q value at high frequencies and low DC resistance
- Wide inductance range
- Excellent solder heat resistance
- Both flow and reflow soldering methods can be employed

Applications

- Personal, cordless phone
- High Freq. communication products
- GPS (global position system)
- Personal computers

Product Identification

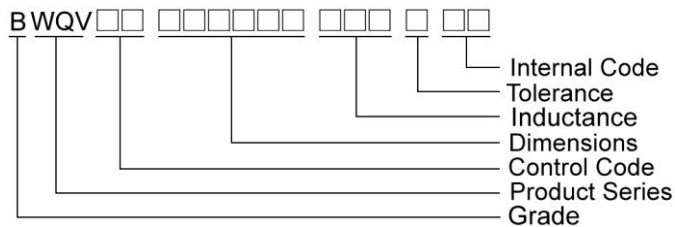

Shape and Dimensions

BWQV00322520

BWQV00453226

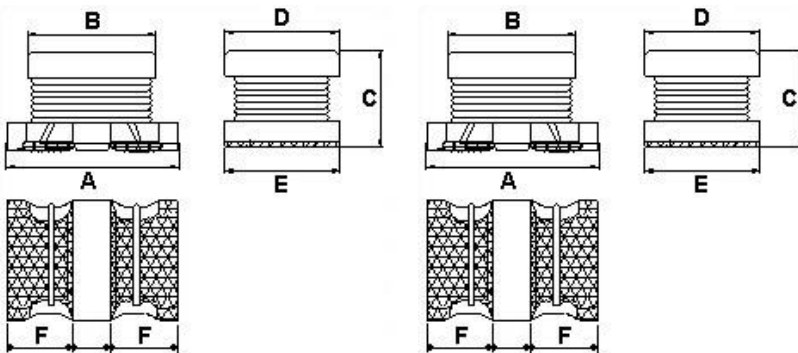

Recommended Pattern

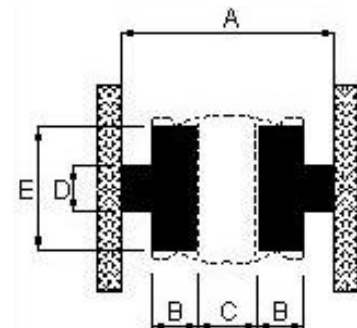

Dimensions in mm

TYPE	Shape and Dimensions						Recommended Pattern				
	A	B	C	D	E	F	A	B	C	D	E
BWQV00322520	3.2±0.3	2.5±0.2	2.0±0.2	2.5±0.2	2.5±0.2	0.95±0.3	5.5	1.0	1.3	1.0	2.0
BWQV00453226	4.5±0.3	3.6±0.2	2.6±0.2	3.2±0.2	3.2±0.2	1.45±0.3	7.5	1.5	1.5	1.5	3.0

SMD Wire Wound Ferrite Chip Inductors – BWQV Series

Electrical Characteristics

Part Number	Inductance (uH)	Tolerance (±%)	Test Frequency (MHz)	Q Min	Test Frequency (MHz)	SRF (MHz) Min	RDC (Ω) Max	Rated current (mA)
BWQV00322520R47□00	0.47	20	1	20	1	150	0.06	1100
BWQV00322520R82□00	0.82	20	1	20	1	120	0.25	450
BWQV003225201R0□00	1.0	20	1	20	1	100	0.50	445
BWQV003225201R2□00	1.2	20	1	20	1	100	0.60	425
BWQV003225201R5□00	1.5	20 / 10	1	20	1	75	0.60	400
BWQV003225201R8□00	1.8	20 / 10	1	20	1	60	0.70	390
BWQV003225202R2□00	2.2	20 / 10	1	20	1	50	0.80	370
BWQV003225202R7□00	2.7	20 / 10	1	20	1	43	0.90	320
BWQV003225203R3□00	3.3	20 / 10	1	20	1	38	1.0	300
BWQV003225203R9□00	3.9	20 / 10	1	20	1	35	1.1	290
BWQV003225204R7□00	4.7	20 / 10	1	20	1	31	1.2	270
BWQV003225205R6□00	5.6	20 / 10	1	20	1	28	1.3	250
BWQV003225206R8□00	6.8	20 / 10	1	20	1	25	1.5	240
BWQV003225208R2□00	8.2	20 / 10	1	20	1	23	1.6	225
BWQV00322520100□00	10	20 / 10	1	35	1	20	1.8	190
BWQV00322520120□00	12	20 / 10	1	35	1	18	2.0	180
BWQV00322520150□00	15	20 / 10	1	35	1	16	2.2	170
BWQV00322520180□00	18	20 / 10	1	35	1	15	2.5	165
BWQV00322520220□00	22	20 / 10 / 5	1	35	1	14	2.8	150
BWQV00322520270□00	27	20 / 10	1	35	1	13	3.1	125
BWQV00322520330□00	33	20 / 10 / 5	1	40	1	12	3.5	115
BWQV00322520390□00	39	20 / 10	1	40	1	11	3.9	110
BWQV00322520470□00	47	20 / 10	1	40	1	11	4.3	100
BWQV00322520560□00	56	20 / 10	1	40	1	10.0	4.9	85
BWQV00322520680□00	68	20 / 10 / 5	1	40	1	9.0	5.5	80
BWQV00322520820□00	82	20 / 10 / 5	1	40	1	8.5	6.2	70
BWQV00322520101□00	100	20 / 10 / 5	1	40	0.796	8.0	7.0	80
BWQV00322520121□00	120	20 / 10	1	40	0.796	7.5	8.0	75
BWQV00322520151□00	150	20 / 10	1	40	0.796	7.0	9.3	70
BWQV00322520181□00	180	20 / 10	1	40	0.796	6.0	10.2	65
BWQV00322520221□00	220	20 / 10	1	40	0.796	5.5	11.8	65
BWQV00322520271□00	270	20 / 10	1	40	0.796	5.0	12.5	65
BWQV00322520331□00	330	20 / 10	1	40	0.796	5.0	13.0	65
BWQV00322520391□00	390	20 / 10	1	50	0.796	5.0	22.0	50
BWQV00322520471□00	470	20 / 10	0.001	50	0.796	5.0	25.0	45
BWQV00322520561□00	560	20 / 10 / 5	0.001	50	0.796	2.0	28.0	40

Note: When ordering, please specify tolerance code. Tolerance : J=±5% , K=±10% , M=±20%

- Operating temperature range – 40°C ~ 125°C (Including self - temperature rise)
- Rated Current : Self temperature rise shall be limited to 35°C Max Inductance drop 10% typ.
- Measure Equipment :
 - L : Agilent HP4285A(1MHz)/Agilent HP4192A(1kHz)
 - Q : Agilent HP4285A
 - SRF : Agilent HP4286A
 - RDC : HP4338B or Chroma 16502
 - Rated Current : HP4284A+HP42841A

Please be sure to request approval specifications that provide further details of the products. Kindly note that the content of these specifications are subject to change or may be discontinued without prior notice. This product may not be designed/used in medical or high risk applications without Chilisin approval. Please contact our sales department before ordering.

SMD Wire Wound Ferrite Chip Inductors – BWQV Series

Electrical Characteristics

Part Number	Inductance (uH)	Tolerance (±%)	Test Frequency (MHz)	Q Min	Test Frequency (MHz)	SRF (MHz) Min	RDC (Ω) Max	Rated current (mA)
BWQV004532261R0□00	1.0	20	1	20	1	120	0.20	500
BWQV004532261R2□00	1.2	20	1	20	1	100	0.20	500
BWQV004532261R5□00	1.5	20	1	20	1	85	0.30	500
BWQV004532261R8□00	1.8	20	1	20	1	75	0.30	500
BWQV004532262R2□00	2.2	20	1	20	1	62	0.30	500
BWQV004532262R7□00	2.7	20	1	20	1	53	0.32	500
BWQV004532263R3□00	3.3	20	1	20	1	47	0.35	500
BWQV004532263R9□00	3.9	20	1	20	1	41	0.38	500
BWQV004532264R7□00	4.7	20 / 10	1	30	1	38	0.40	500
BWQV004532265R6□00	5.6	20 / 10	1	30	1	33	0.47	500
BWQV004532266R8□00	6.8	20 / 10	1	30	1	31	0.50	450
BWQV004532268R2□00	8.2	20 / 10	1	30	1	27	0.56	450
BWQV00453226100□00	10	20 / 10	1	35	1	23	0.56	400
BWQV00453226120□00	12	20 / 10	1	35	1	21	0.62	380
BWQV00453226150□00	15	20 / 10 / 5	1	35	1	19	0.73	360
BWQV00453226180□00	18	20 / 10	1	35	1	17	0.82	340
BWQV00453226220□00	22	20 / 10 / 5	1	35	1	15	0.94	320
BWQV00453226270□00	27	20 / 10 / 5	1	35	1	14	1.1	300
BWQV00453226330□00	33	20 / 10	1	35	1	12	1.2	270
BWQV00453226390□00	39	20 / 10 / 5	1	35	1	11	1.4	240
BWQV00453226470□00	47	20 / 10 / 5	1	35	1	10	1.5	220
BWQV00453226560□00	56	20 / 10	1	35	1	9.3	1.7	200
BWQV00453226680□00	68	20 / 10 / 5	1	35	1	8.4	1.9	180
BWQV00453226820□00	82	20 / 10	1	35	1	7.5	2.2	170
BWQV00453226101□00	100	20 / 10 / 5	1	40	0.796	6.8	2.5	160
BWQV00453226121□00	120	20 / 10	1	40	0.796	6.2	3.0	150
BWQV00453226151□00	150	20 / 10	1	40	0.796	5.5	3.7	130
BWQV00453226181□00	180	20 / 10	1	40	0.796	5.0	4.5	120
BWQV00453226221□00	220	20 / 10 / 5	1	40	0.796	4.5	5.4	110
BWQV00453226271□00	270	20 / 10	1	40	0.796	4.0	6.8	100
BWQV00453226331□00	330	20 / 10	1	40	0.796	3.6	8.2	95
BWQV00453226391□00	390	20 / 10 / 5	1	40	0.796	3.3	9.7	90
BWQV00453226471□00	470	20 / 10 / 5	0.001	40	0.796	3.0	11.8	80
BWQV00453226561□00	560	20 / 10 / 5	0.001	40	0.796	2.7	14.5	70

Note: When ordering, please specify tolerance code. Tolerance : J=±5% , K=±10% , M=±20%

- Operating temperature range – 40°C ~ 125°C (Including self - temperature rise)
- Rated Current : Self temperature rise shall be limited to 35°C Max Inductance drop 10% typ.
- Measure Equipment :
 - L : Agilent HP4285A(1MHz)/Agilent HP4192A(1kHz)
 - Q : Agilent HP4285A
 - SRF : Agilent HP4291A
 - RDC : HP4338B or Chroma 16502
 - Rated Current : HP4284A+HP42841A

Please be sure to request approval specifications that provide further details of the products. Kindly note that the content of these specifications are subject to change or may be discontinued without prior notice. This product may not be designed/used in medical or high risk applications without Chilisin approval. Please contact our sales department before ordering.

Electrical Characteristics

Part Number	Inductance (uH)	Tolerance (±%)	Test Frequency (MHz)	Q Min	Test Frequency (MHz)	SRF (MHz) Min	RDC (Ω) Max	Rated current (mA)
BWQV00453226681□00	680	20 / 10	0.001	40	0.796	2.5	17.5	65
BWQV00453226821□00	820	20 / 10	0.001	40	0.796	2.2	20.5	60
BWQV00453226102□00	1000	20 / 10 / 5	0.001	40	0.252	2.0	25.0	50
BWQV00453226122□00	1200	20 / 10	0.001	40	0.252	1.8	30.0	45
BWQV00453226152□00	1500	20 / 10	0.001	40	0.252	1.6	37.0	40
BWQV00453226182□00	1800	20 / 10	0.001	40	0.252	1.5	45.0	35
BWQV00453226222□00	2200	20 / 10 / 5	0.001	40	0.252	1.3	50.0	30

Note: When ordering, please specify tolerance code. Tolerance : J=±5% , K=±10% , M=±20%

- Operating temperature range – 40°C ~ 125°C (Including self - temperature rise)
- Rated Current : Self temperature rise shall be limited to 35°C Max Inductance drop 10% typ.
- Measure Equipment :
 - L : Agilent HP4285A(1MHz)/Agilent HP4192A(1kHz)
 - Q : Agilent HP4285A
 - SRF : Agilent HP4291A
 - RDC : HP4338B or Chroma 16502
 - Rated Current : HP4284A+HP42841A

SMD Wire Wound Ferrite Chip Inductors - BWQV Series

Packaging Specifications

Tape Dimensions

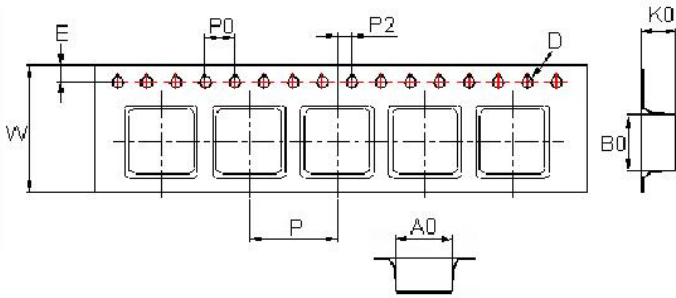

Tape Material

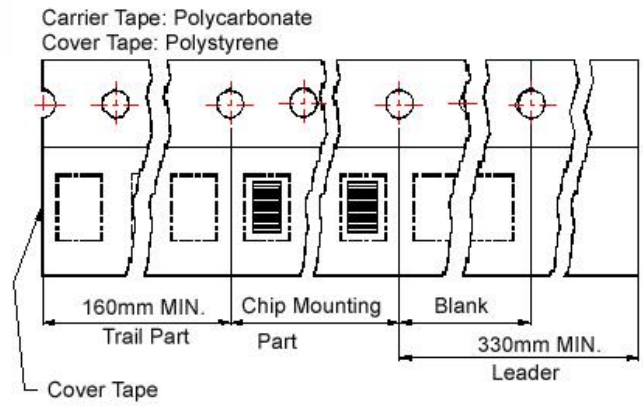

Reel Dimensions

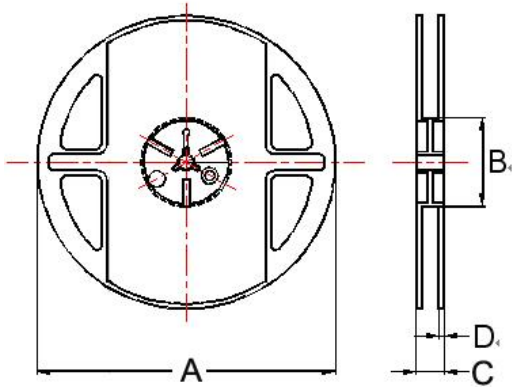



Dimensions in mm



TYPE	Tape Dimensions									Reel Dimensions				Quantity
	A0	B0	K0	D	E	W	P	P0	P2	A	B	C	D	PCS / REEL
BWQV00322520	2.85	3.60	2.25	1.5	1.75	8	4	4	2	178	60	9	1.5	2000
BWQV00453226	3.60	4.90	3.00	1.5	1.75	12	8	4	2	178	60	13.2	1.5	500

Looking for pricing, stock, or lifecycle information?

Click below to explore more details on WIN SOURCE:

-  [View BWQV003225206R8K00 on WIN SOURCE](#)
-  [Chilisin Information](#)

Optimize Your Supply Chain with WIN SOURCE Solutions

-  Global Sourcing Solution
-  Obsolete Management
-  Cost Control Management
-  Shortage Management
-  Alternative Solution
-  Excess Inventory Management