



**THE DATASHEET OF  
BTA06T-600CWRG**





# BTA06T-600CWRG

## 6 A Snubberless™ Triac

### Features

- High static and dynamic commutation
- BTA series is UL1557 certified (File ref.: 81734)
- Package is RoHS (2002/95/EC) compliant
- $I_{GT} = 35 \text{ mA}$

### Applications

Specially designed for power tool applications, it can also be used to drive loads like motor speed controller, kitchen equipments such as electro valves, light dimmers and similar.

### Description

Available in through-hole package, the Triac BTA06T-600CW is suitable for general purpose ac switching.

Being a fully insulated package, the BTA06T-600CW provides insulation rated at 2500 V rms.

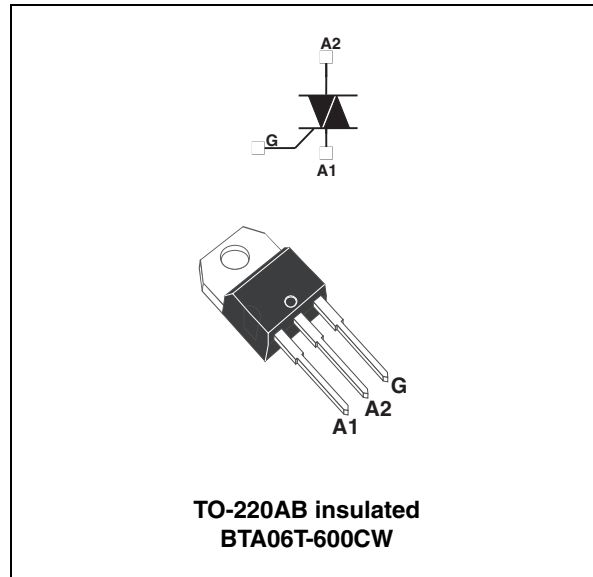

TM: Snubberless is a trademark of STMicroelectronics

# 1 Characteristics

**Table 1. Absolute maximum ratings (limiting values)**

Symbol	Parameter		Value	Unit	
$I_{T(RMS)}$	On-state rms current (full sine wave)		$T_c = 100\text{ }^\circ\text{C}$	6	A
$I_{TSM}$	Non repetitive surge peak on-state current (full cycle sine wave, $T_j$ initial = $25\text{ }^\circ\text{C}$ )	F = 60 Hz	t = 16.7 ms	47	A
		F = 50 Hz	t = 20 ms	45	
$I^2t$	$I^2t$ Value for fusing	$t_p = 10\text{ ms}$		13	A <sup>2</sup> s
dI/dt	Critical rate of rise of on-state current $I_G = 2 \times I_{GT}$ , $t_r \leq 100\text{ ns}$	F = 120 Hz	$T_j = 125\text{ }^\circ\text{C}$	50	A/ $\mu$ s
$V_{DSM}/V_{RSM}$	Non repetitive surge peak off-state voitage	$t_p = 10\text{ ms}$	$T_j = 25\text{ }^\circ\text{C}$	$V_{DRM}/V_{RRM} + 100$	V
$I_{GM}$	Peak gate current	$t_p = 20\text{ }\mu\text{s}$	$T_j = 125\text{ }^\circ\text{C}$	4	A
$P_{G(AV)}$	Average gate power dissipation		$T_j = 125\text{ }^\circ\text{C}$	1	W
$T_{stg}$	Storage junction temperature range			-40 to +150	$^\circ\text{C}$
$T_j$	Operating junction temperature range			-40 to +125	

**Table 2. Electrical characteristics, Snubberless (3 quadrants) ( $T_j = 25\text{ }^\circ\text{C}$ , unless otherwise specified)**

Symbol	Test conditions	Quadrant		Value	Unit
$I_{GT}^{(1)}$	$V_D = 12\text{ V}$ $R_L = 30\text{ }\Omega$	I - II - III	MAX	35	mA
$V_{GT}$	$V_D = 12\text{ V}$ $R_L = 30\text{ }\Omega$	I - II - III	MAX	1.3	V
$V_{GD}$	$V_D = V_{DRM}$ $R_L = 3.3\text{ k}\Omega$	I - II - III	MIN	0.2	V
$I_H^{(2)}$	$I_T = 100\text{ mA}$		MAX	35	mA
$I_L$	$I_G = 1.2 \times I_{GT}$	I - III	MAX	50	mA
		II		80	
dV/dt <sup>(2)</sup>	$V_D = 67\% V_{DRM}$ , gate open, $T_j = 125\text{ }^\circ\text{C}$		MIN	750	V/ $\mu$ s
(dI/dt) <sub>C</sub> <sup>(2)</sup>	Without snubber, $T_j = 125\text{ }^\circ\text{C}$		MIN	8.0	A/ms

1. Minimum  $I_{GT}$  is guaranteed at 5% of  $I_{GT}$  max.
2. For both polarities of A2 pin referenced to A1 pin

**Table 3. Static electrical characteristics**

Symbol	Test conditions		Value	Unit		
$V_{TM}^{(1)}$	$I_{TM} = 8.5\text{ A}$ , $t_p = 380\text{ }\mu\text{s}$	$T_j = 25\text{ }^\circ\text{C}$	MAX	1.6	V	
$V_{TO}^{(1)}$	Threshold voltage		$T_j = 125\text{ }^\circ\text{C}$	MAX	0.85	V
$R_D^{(1)}$	Dynamic resistance		$T_j = 125\text{ }^\circ\text{C}$	MAX	80	m $\Omega$
$I_{DRM}$ $I_{RRM}$	$V_{DRM} = V_{RRM}$	$T_j = 25\text{ }^\circ\text{C}$	MAX	5	$\mu$ A	
		$T_j = 125\text{ }^\circ\text{C}$		1	mA	

1. For both polarities of A2 pin referenced to A1 pin

**Table 4. Thermal resistances**

Symbol	Parameter	Value	Unit
$R_{th(j-c)}$	Junction to case (ac)	3.4	°C/W
$R_{th(j-a)}$	Junction to ambient	60	

**Figure 1. Maximum power dissipation versus rms on-state current (full cycle)**

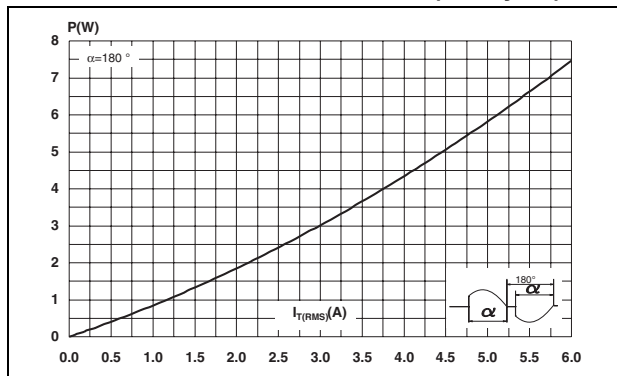

**Figure 2. On-state current (rms) versus case temperature (full cycle)**

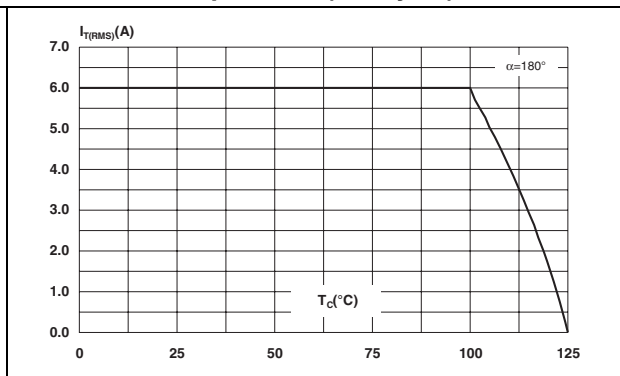

**Figure 3. On-state current (rms) versus ambient temperature (free air convection)**

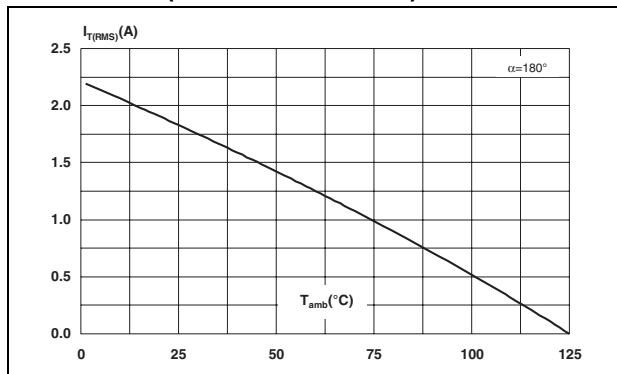

**Figure 4. Relative variation of thermal impedance versus pulse duration**

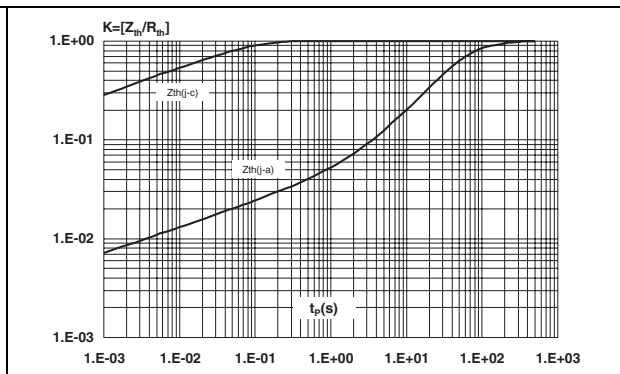

**Figure 5. Relative variation of gate trigger current, and gate trigger voltage versus junction temperature**

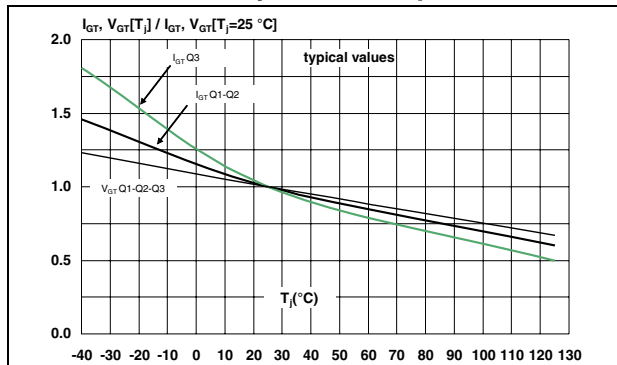

**Figure 6. Relative variation of holding current and latching current versus junction temperature**

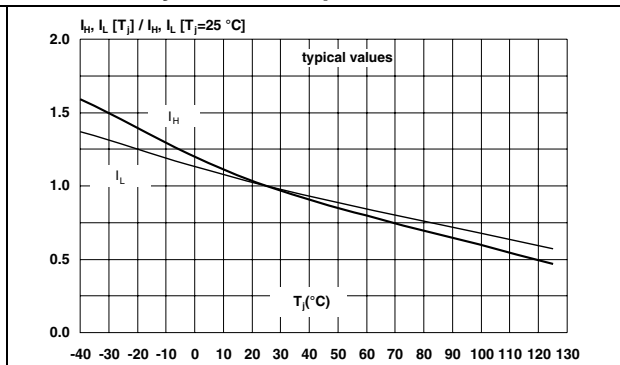

Figure 7. Surge peak on-state current versus number of cycles

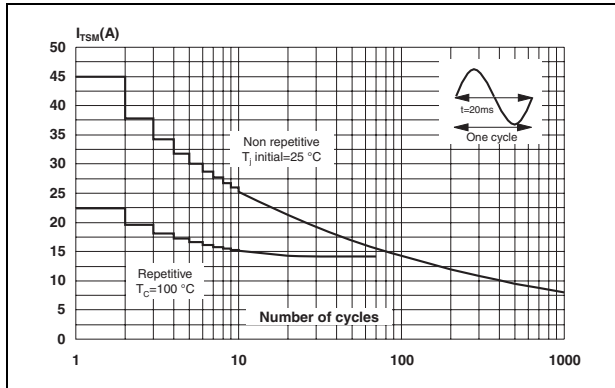

Figure 8. Non-repetitive surge peak on-state current for sinusoidal

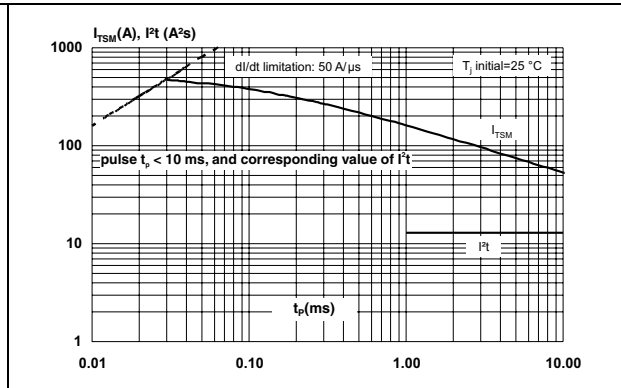

Figure 9. On-state characteristics (maximum values)

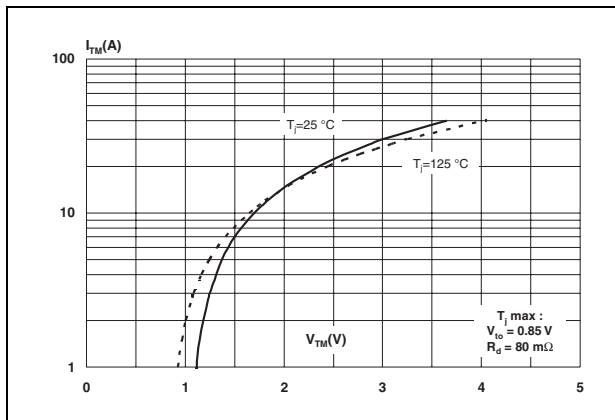

Figure 10. Relative variation of critical rate of decrease of main current ( $di/dt$ )<sub>c</sub> versus junction temperature

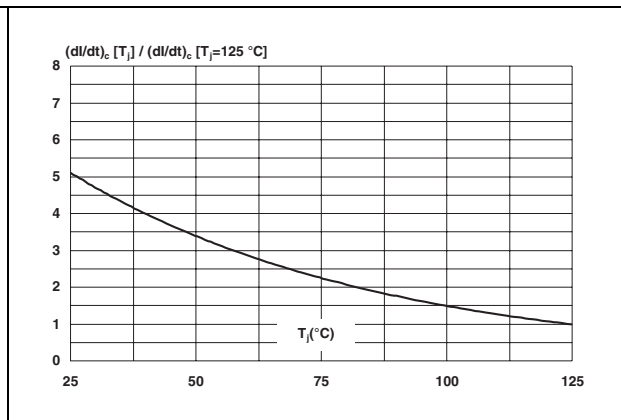

Figure 11. Relative variation of critical rate of decrease of main current ( $di/dt$ )<sub>c</sub> versus reapplied ( $dV/dt$ )<sub>c</sub>

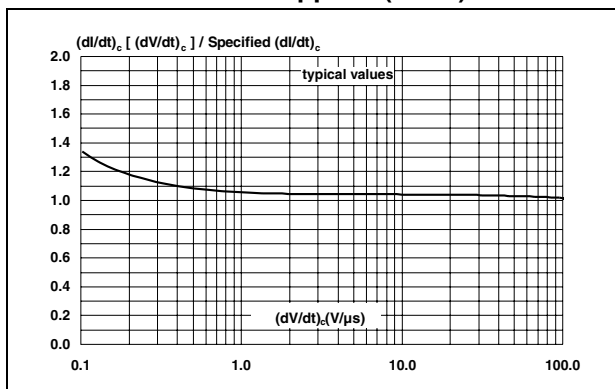
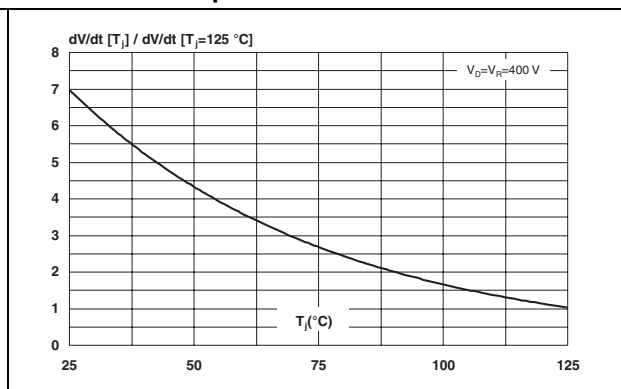
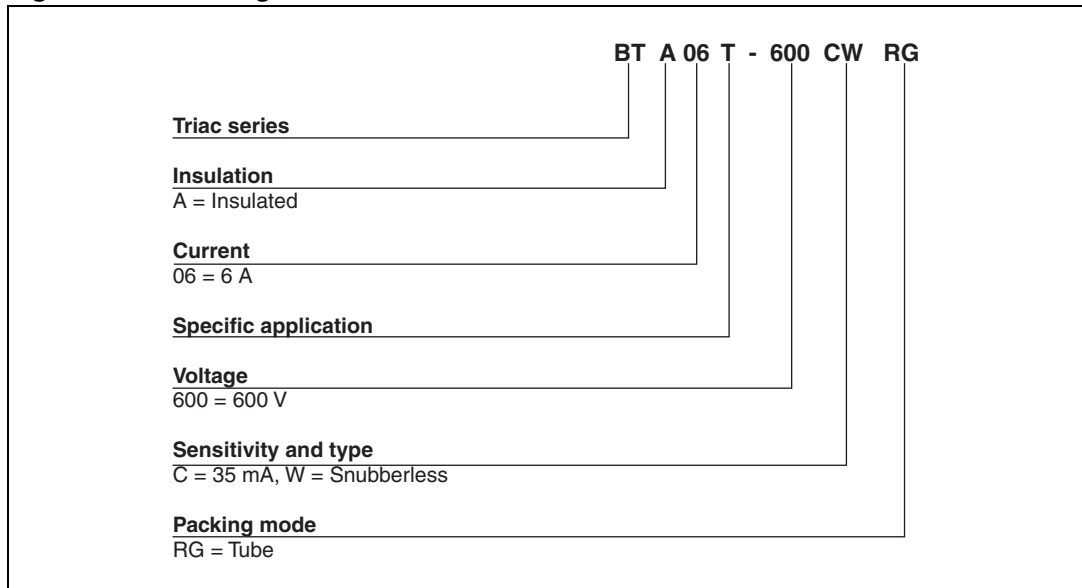

Figure 12. Relative variation of static  $dV/dt$  immunity versus junction temperature



## 2 Ordering information

Figure 13. Ordering information scheme



### 3 Package information

- Epoxy meets UL94, V0
- Lead-free packages

In order to meet environmental requirements, ST offers these devices in different grades of ECOPACK® packages, depending on their level of environmental compliance. ECOPACK® specifications, grade definitions and product status are available at: [www.st.com](http://www.st.com). ECOPACK® is an ST trademark.

**Table 5. TO-220AB insulated dimensions**

Ref.	Dimensions					
	Millimeters			Inches		
	Min.	Typ.	Max.	Min.	Typ.	Max.
A	15.20		15.90	0.598		0.625
a1		3.75			0.147	
a2	13.00		14.00	0.511		0.551
B	10.00		10.40	0.393		0.409
b1	0.61		0.88	0.024		0.034
b2	1.23		1.32	0.048		0.051
C	4.40		4.60	0.173		0.181
c1	0.49		0.70	0.019		0.027
c2	2.40		2.72	0.094		0.107
e	2.40		2.70	0.094		0.106
F	6.20		6.60	0.244		0.259
ØI	3.75		3.85	0.147		0.151
I4	15.80	16.40	16.80	0.622	0.646	0.661
L	2.65		2.95	0.104		0.116
I2	1.14		1.70	0.044		0.066
I3	1.14		1.70	0.044		0.066
M		2.60			0.102	

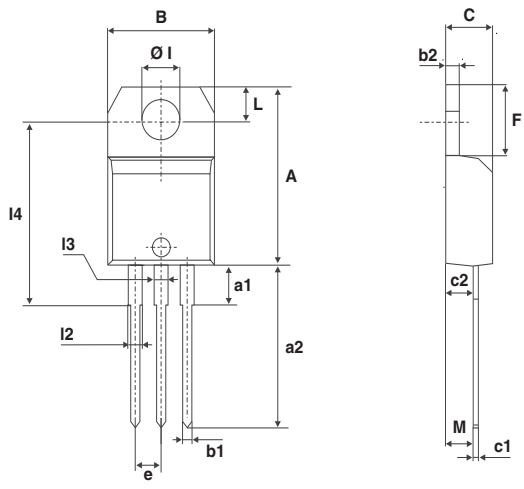

## 4 Ordering information

Table 6. Ordering information

Order code	Marking	Package	Weight	Base qty	Packing mode
BTA06T-600CWRG	BTA06T-600CW	TO-220AB ins	2.3 g	50	Tube

## 5 Revision history

Table 7. Document revision history

Date	Revision	Changes
15-Nov-2007	1	Initial release.
17-Jun-2010	2	Updated title <a href="#">on page 1</a> . Updated ECOPACK statement.

**Please Read Carefully:**

Information in this document is provided solely in connection with ST products. STMicroelectronics NV and its subsidiaries ("ST") reserve the right to make changes, corrections, modifications or improvements, to this document, and the products and services described herein at any time, without notice.

All ST products are sold pursuant to ST's terms and conditions of sale.

Purchasers are solely responsible for the choice, selection and use of the ST products and services described herein, and ST assumes no liability whatsoever relating to the choice, selection or use of the ST products and services described herein.

No license, express or implied, by estoppel or otherwise, to any intellectual property rights is granted under this document. If any part of this document refers to any third party products or services it shall not be deemed a license grant by ST for the use of such third party products or services, or any intellectual property contained therein or considered as a warranty covering the use in any manner whatsoever of such third party products or services or any intellectual property contained therein.

**UNLESS OTHERWISE SET FORTH IN ST'S TERMS AND CONDITIONS OF SALE ST DISCLAIMS ANY EXPRESS OR IMPLIED WARRANTY WITH RESPECT TO THE USE AND/OR SALE OF ST PRODUCTS INCLUDING WITHOUT LIMITATION IMPLIED WARRANTIES OF MERCHANTABILITY, FITNESS FOR A PARTICULAR PURPOSE (AND THEIR EQUIVALENTS UNDER THE LAWS OF ANY JURISDICTION), OR INFRINGEMENT OF ANY PATENT, COPYRIGHT OR OTHER INTELLECTUAL PROPERTY RIGHT.**

**UNLESS EXPRESSLY APPROVED IN WRITING BY AN AUTHORIZED ST REPRESENTATIVE, ST PRODUCTS ARE NOT RECOMMENDED, AUTHORIZED OR WARRANTED FOR USE IN MILITARY, AIR CRAFT, SPACE, LIFE SAVING, OR LIFE SUSTAINING APPLICATIONS, NOR IN PRODUCTS OR SYSTEMS WHERE FAILURE OR MALFUNCTION MAY RESULT IN PERSONAL INJURY, DEATH, OR SEVERE PROPERTY OR ENVIRONMENTAL DAMAGE. ST PRODUCTS WHICH ARE NOT SPECIFIED AS "AUTOMOTIVE GRADE" MAY ONLY BE USED IN AUTOMOTIVE APPLICATIONS AT USER'S OWN RISK.**

Resale of ST products with provisions different from the statements and/or technical features set forth in this document shall immediately void any warranty granted by ST for the ST product or service described herein and shall not create or extend in any manner whatsoever, any liability of ST.

ST and the ST logo are trademarks or registered trademarks of ST in various countries.

Information in this document supersedes and replaces all information previously supplied.

The ST logo is a registered trademark of STMicroelectronics. All other names are the property of their respective owners.

© 2010 STMicroelectronics - All rights reserved

STMicroelectronics group of companies

Australia - Belgium - Brazil - Canada - China - Czech Republic - Finland - France - Germany - Hong Kong - India - Israel - Italy - Japan - Malaysia - Malta - Morocco - Philippines - Singapore - Spain - Sweden - Switzerland - United Kingdom - United States of America

[www.st.com](http://www.st.com)

## Looking for pricing, stock, or lifecycle information?

Click below to explore more details on WIN SOURCE:

- ⊖ [View BTA06T-600CW RG](#) on WIN SOURCE
- ⊖ [STMicroelectronics](#) Information

## Optimize Your Supply Chain with WIN SOURCE Solutions

- ✓ Global Sourcing Solution
- ✓ Obsolete Management
- ✓ Cost Control Management
- ✓ Shortage Management
- ✓ Alternative Solution
- ✓ Excess Inventory Management