



**THE DATASHEET OF
BTA06-800CRG**





BTA06 and BTB06 Series

SNUBBERLESSTM, LOGIC LEVEL & STANDARD

6A TRIACs

Table 1: Main Features

Symbol	Value	Unit
$I_{T(RMS)}$	6	A
V_{DRM}/V_{RRM}	600 and 800	V
$I_{GT}(Q_1)$	5 to 50	mA

DESCRIPTION

Available either in through-hole or surface-mount packages, the **BTA06** and **BTB06** triac series is suitable for general purpose AC switching. They can be used as an ON/OFF function in applications such as static relays, heating regulation, induction motor starting circuits... or for phase control operation in light dimmers, motor speed controllers,...

The snubberless and logic level versions (BTA/BTB...W) are specially recommended for use on inductive loads, thanks to their high commutation performances.

By using an internal ceramic pad, the BTA series provides voltage insulated tab (rated at 2500V_{RMS}) complying with UL standards (File ref.: E81734).

Table 3: Absolute Maximum Ratings

Symbol	Parameter	Value	Unit		
$I_{T(RMS)}$	RMS on-state current (full sine wave)	TO-220AB	$T_c = 110^\circ\text{C}$	6	A
		TO-220AB Ins.	$T_c = 105^\circ\text{C}$		
I_{TSM}	Non repetitive surge peak on-state current (full cycle, T_j initial = 25°C)	F = 50 Hz	t = 20 ms	60	A
		F = 60 Hz	t = 16.7 ms	63	
I^2t	I^2t Value for fusing	$t_p = 10$ ms		21	A ² s
di/dt	Critical rate of rise of on-state current $I_G = 2 \times I_{GT}$, $t_r \leq 100$ ns	F = 120 Hz	$T_j = 125^\circ\text{C}$	50	A/ μ s
I_{GM}	Peak gate current	$t_p = 20$ μ s	$T_j = 125^\circ\text{C}$	4	A
$P_{G(AV)}$	Average gate power dissipation	$T_j = 125^\circ\text{C}$		1	W
T_{stg} T_j	Storage junction temperature range Operating junction temperature range			- 40 to + 150 - 40 to + 125	°C

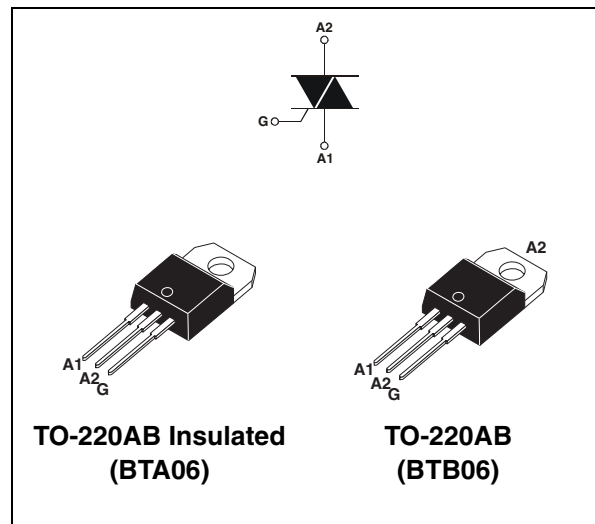

Table 2: Order Codes

Part Number	Marking
BTA06-xxxxxRG	See page table 8 on page 6
BTB06-xxxxxRG	

BTA06 and BTB06 Series

Tables 4: Electrical Characteristics ($T_j = 25^\circ\text{C}$, unless otherwise specified)

■ SNUBBERLESS and Logic Level (3 quadrants)

Symbol	Test Conditions	Quadrant		BTA06 / BTB06				Unit
				TW	SW	CW	BW	
I_{GT} (1)	$V_D = 12\text{ V}$ $R_L = 30\ \Omega$	I - II - III	MAX.	5	10	35	50	mA
V_{GT}		I - II - III	MAX.	1.3				V
V_{GD}	$V_D = V_{DRM}$ $R_L = 3.3\ \text{k}\Omega$ $T_j = 125^\circ\text{C}$	I - II - III	MIN.	0.2				V
I_H (2)	$I_T = 100\ \text{mA}$		MAX.	10	15	35	50	mA
I_L	$I_G = 1.2 I_{GT}$	I - III	MAX.	10	25	50	70	mA
		II		15	30	60	80	
dV/dt (2)	$V_D = 67\% V_{DRM}$ gate open $T_j = 125^\circ\text{C}$		MIN.	20	40	400	1000	V/ μs
$(dI/dt)_c$ (2)	$(dV/dt)_c = 0.1\ \text{V}/\mu\text{s}$ $T_j = 125^\circ\text{C}$		MIN.	2.7	3.5	-	-	A/ms
	$(dV/dt)_c = 10\ \text{V}/\mu\text{s}$ $T_j = 125^\circ\text{C}$			1.2	2.4	-	-	
	Without snubber $T_j = 125^\circ\text{C}$			-	-	3.5	5.3	

■ Standard (4 quadrants)

Symbol	Test Conditions	Quadrant		BTA06 / BTB06		Unit
				C	B	
I_{GT} (1)	$V_D = 12\ \text{V}$ $R_L = 30\ \Omega$	I - II - III IV	MAX.	25 50	50 100	mA
V_{GT}		ALL	MAX.	1.3		V
V_{GD}	$V_D = V_{DRM}$ $R_L = 3.3\ \text{k}\Omega$ $T_j = 125^\circ\text{C}$	ALL	MIN.	0.2		V
I_H (2)	$I_T = 500\ \text{mA}$		MAX.	25	50	mA
I_L	$I_G = 1.2 I_{GT}$	I - III - IV	MAX.	40	50	mA
		II		80	100	
dV/dt (2)	$V_D = 67\% V_{DRM}$ gate open $T_j = 125^\circ\text{C}$		MIN.	200	400	V/ μs
$(dV/dt)_c$ (2)	$(dI/dt)_c = 2.7\ \text{A}/\text{ms}$ $T_j = 125^\circ\text{C}$		MIN.	5	10	V/ μs

Table 5: Static Characteristics

Symbol	Test Conditions			Value	Unit	
V_{TM} (2)	$I_{TM} = 8.5\ \text{A}$	$t_p = 380\ \mu\text{s}$	$T_j = 25^\circ\text{C}$	MAX.	1.55	V
V_{t0} (2)	Threshold voltage		$T_j = 125^\circ\text{C}$	MAX.	0.85	V
R_d (2)	Dynamic resistance		$T_j = 125^\circ\text{C}$	MAX.	60	m Ω
I_{DRM} I_{RRM}	$V_{DRM} = V_{RRM}$		$T_j = 25^\circ\text{C}$	MAX.	5	μA
			$T_j = 125^\circ\text{C}$		1	mA

Note 1: minimum I_{GT} is guaranteed at 5% of I_{GT} max.

Note 2: for both polarities of A2 referenced to A1.

Table 6: Thermal resistance

Symbol	Parameter		Value	Unit
$R_{th(j-c)}$	Junction to case (AC)	TO-220AB	1.8	$^{\circ}\text{C}/\text{W}$
		TO-220AB Insulated	2.7	
$R_{th(j-a)}$	Junction to ambient	TO-220AB	60	$^{\circ}\text{C}/\text{W}$
		TO-220AB Insulated		

Figure 1: Maximum power dissipation versus RMS on-state current (full cycle)



Figure 2: RMS on-state current versus case temperature (full cycle)

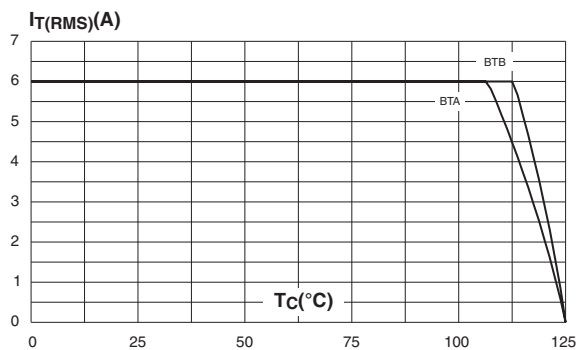

Figure 3: Relative variation of thermal impedance versus pulse duration



Figure 4: On-state characteristics (maximum values)

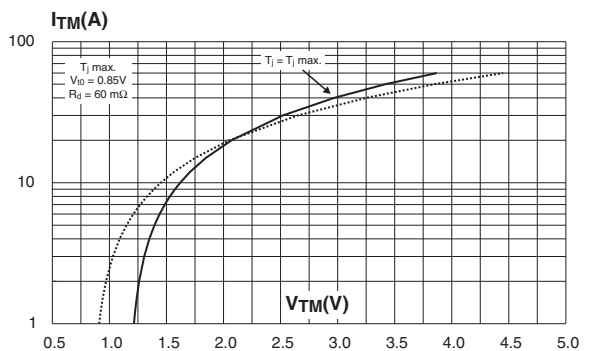

Figure 5: Surge peak on-state current versus number of cycles

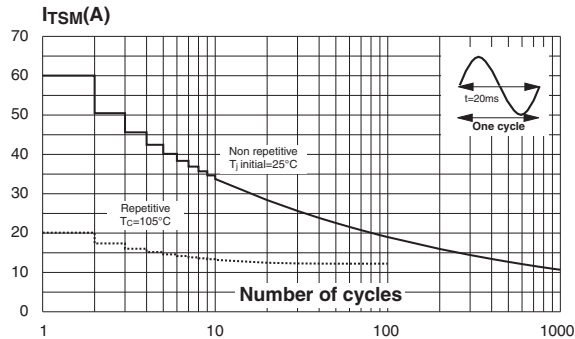

Figure 6: Non-repetitive surge peak on-state current for a sinusoidal pulse with width $t_p < 10$ ms and corresponding value of I^2t

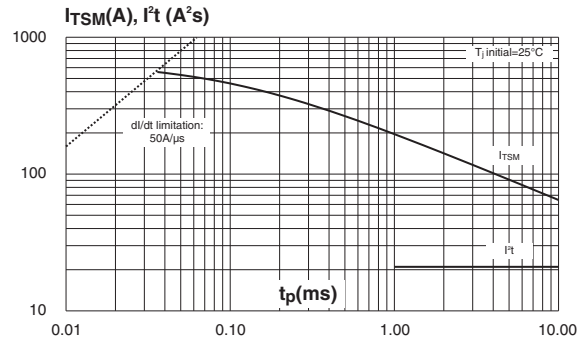

Figure 7: Relative variation of gate trigger current, holding current and latching current versus junction temperature (typical values)

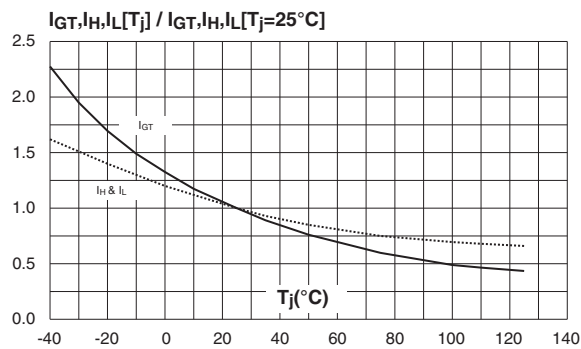

Figure 8: Relative variation of critical rate of decrease of main current versus $(dV/dt)_c$ (typical values) (Snubberless & logic level types)

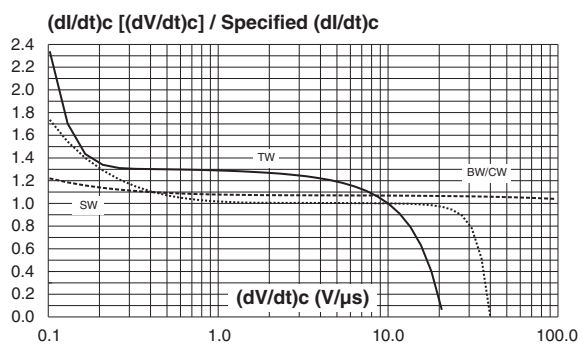

Figure 9: Relative variation of critical rate of decrease of main current versus $(dV/dt)_c$ (typical values) (Standard types)

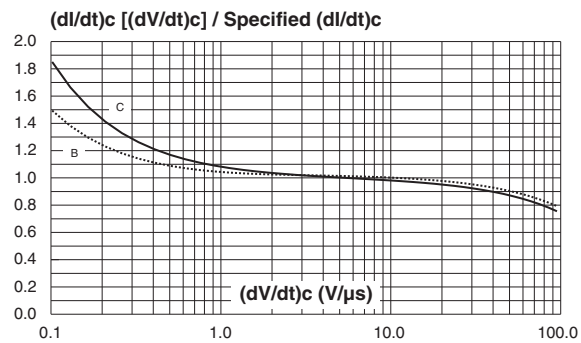

Figure 10: Relative variation of critical rate of decrease of main current versus junction temperature

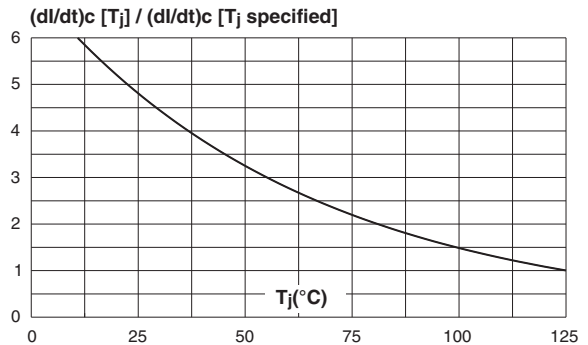

Figure 11: Ordering Information Scheme



Table 7: Product Selector

Part Number	Voltage (xxx)		Sensitivity	Type	Package
	600 V	800 V			
BTA/BTB06-xxxB	X	X	50 mA	Standard	TO-220AB
BTA/BTB06-xxxBW	X	X	50 mA	Snubberless	TO-220AB
BTA/BTB06-xxxC	X	X	25 mA	Standard	TO-220AB
BTA/BTB06-xxxCW	X	X	35 mA	Snubberless	TO-220AB
BTA/BTB06-xxxSW	X	X	10 mA	Logic level	TO-220AB
BTA/BTB06-xxxTW	X	X	5 mA	Logic Level	TO-220AB

BTB: non insulated TO-220AB package

BTA06 and BTB06 Series

Figure 12: TO-220AB (insulated and non insulated) Package Mechanical Data

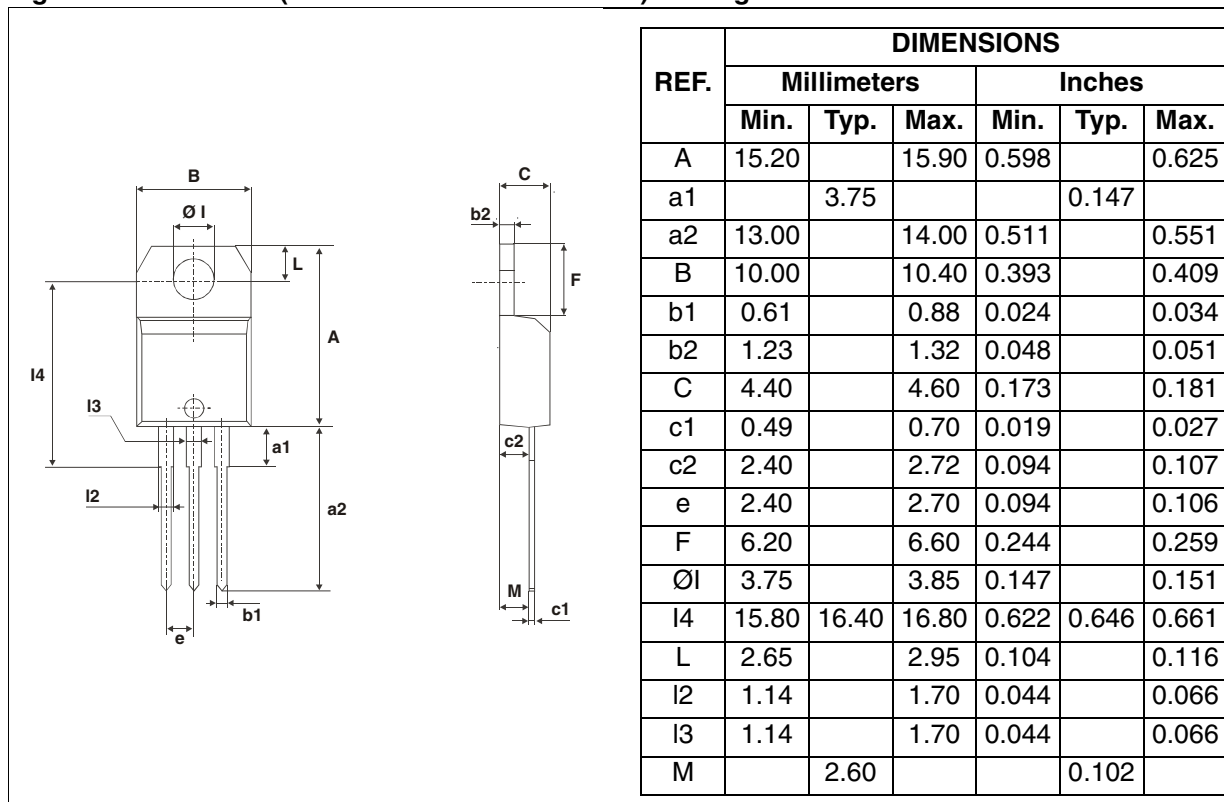

In order to meet environmental requirements, ST offers these devices in ECOPACK® packages. These packages have a Lead-free second level interconnect. The category of second level interconnect is marked on the package and on the inner box label, in compliance with JEDEC Standard JESD97. The maximum ratings related to soldering conditions are also marked on the inner box label. ECOPACK is an ST trademark. ECOPACK specifications are available at: www.st.com.

Table 8: Ordering Information

Ordering type	Marking	Package	Weight	Base qty	Delivery mode
BTA/BTB06-xxxzyzRG	BTA/BTB06-xxxzyz	TO-220AB	2.3 g	50	Tube

Note: xxx = voltage, yy = sensitivity, z = type

Table 9: Revision History

Date	Revision	Description of Changes
Apr-2002	5A	Last update.
13-Feb-2006	6	TO-220AB delivery mode changed from bulk to tube. ECOPACK statement added.

Information furnished is believed to be accurate and reliable. However, STMicroelectronics assumes no responsibility for the consequences of use of such information nor for any infringement of patents or other rights of third parties which may result from its use. No license is granted by implication or otherwise under any patent or patent rights of STMicroelectronics. Specifications mentioned in this publication are subject to change without notice. This publication supersedes and replaces all information previously supplied. STMicroelectronics products are not authorized for use as critical components in life support devices or systems without express written approval of STMicroelectronics.

The ST logo is a registered trademark of STMicroelectronics.
All other names are the property of their respective owners



© 2006 STMicroelectronics - All rights reserved

STMicroelectronics group of companies

Australia - Belgium - Brazil - Canada - China - Czech Republic - Finland - France - Germany - Hong Kong - India - Israel - Italy - Japan -
Malaysia - Malta - Morocco - Singapore - Spain - Sweden - Switzerland - United Kingdom - United States of America
www.st.com

Looking for pricing, stock, or lifecycle information?

Click below to explore more details on WIN SOURCE:

-  [View BTA06-800CRG on WIN SOURCE](#)
-  [STMicroelectronics Information](#)

Optimize Your Supply Chain with WIN SOURCE Solutions

-  Global Sourcing Solution
-  Obsolete Management
-  Cost Control Management
-  Shortage Management
-  Alternative Solution
-  Excess Inventory Management