



**THE DATASHEET OF
AU-33.000MBE-T**



SMD Oscillators- CMOS Output 3.2 x 2.5 x 1.0 mm AU Series



Features

- Ultra Small SMD seam sealed clock crystal oscillator units.
- RoHS Compliant / Pb Free.
- 32.768 KHz CXO available.

Electrical Specifications

Item / Type	AU	
Output Type	CMOS	
Output Load	15 pF , or 30 pF	
Oscillation Mode	Fundamental / 3rd Overtone	
Supply Voltage	1.8 V	2.5 V , 3.3 V
Frequency Range	1 ~ 106.25 MHz	
Frequency Stability	± 50 ppm	
Operating Temperature Range	-40 ~ + 85 °C	
Storage Temperature Range	- 55 ~ + 125 °C	
Voltage Vol (Max.) / Voh (Min.)	0.1 VDD / 0.9 VDD	
Rise (Tr) / Fall (Tf) Time	10 ns Max.	
Supply Current	4 mA Max.	6 mA Max.
Symmetry	45 ~ 55 %	
Start-up Time	10 ms Max.	
Phase Jitter (12 KHz ~ 20 MHz)	1 ps Max.	
Aging (at 25 °C)	± 3 ppm / year Max.	
Reliability Standard	AEC-Q100	

Dimensions

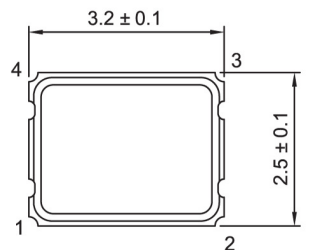

PAD FUNCTION:
1:ENABLE CONTROL
2:GND
3:OUT
4:VDD

Suggested Layout

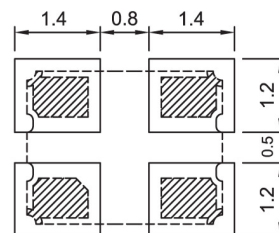
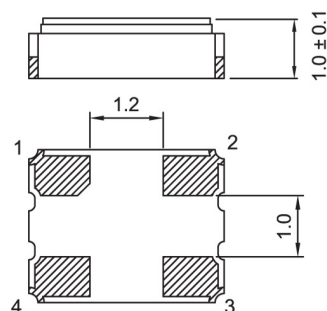

Units: mm

Remark : Specification subject to change without prior notice. Please confirm with our sales.

Looking for pricing, stock, or lifecycle information?

Click below to explore more details on WIN SOURCE:

 [View AU-33.000MBE-T on WIN SOURCE](#)

 [TXC CORPORATION](#) Information

Optimize Your Supply Chain with WIN SOURCE Solutions

-  Global Sourcing Solution
-  Obsolete Management
-  Cost Control Management
-  Shortage Management
-  Alternative Solution
-  Excess Inventory Management