



**THE DATASHEET OF  
ATV30C301J-HF**



# SMD Transient Voltage Suppressor

## ATV30C5V0-HF Thru. ATV30C441-HF

Working Peak Reverse Voltage: 5.0 to 440 Volts

Power Dissipation: 3000 Watts

RoHS Device

Halogen Free

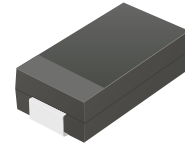

### Features

- Glass passivated chip.
- 3000W peak pulse power capability with a 10/1000 $\mu$ s waveform, repetitive rate (duty cycle):0.01%
- Low leakage.
- Uni and Bidirectional unit.
- Excellent clamping capability.
- Comply with AEC-Q101
- Very fast response time.
- UL recognized file # E349157  Range: ATV30C5V0J(B) thru. ATV30C171J(B)

### Mechanical Data

- Case: DO-214AB/SMC molded plastic.
- Epoxy: UL 94V-0 rate flame retardant
- Terminals: Solderable per MIL-STD-750, method 2026.
- Polarity: Color band denoted cathode end except bipolar.
- Weight: 0.230 gram (approx.)

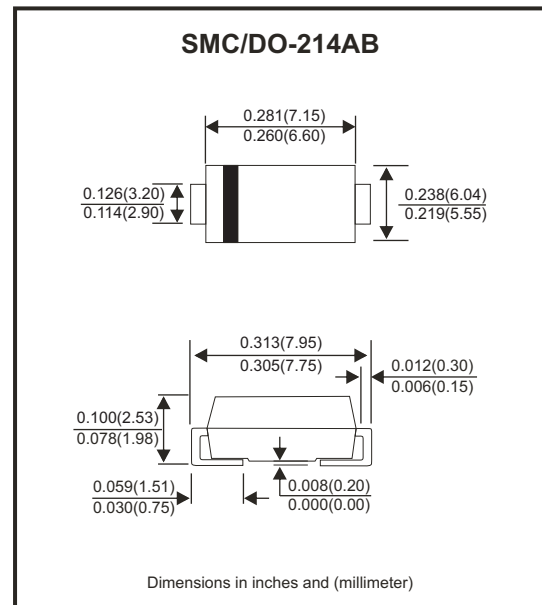

### Circuit Diagram

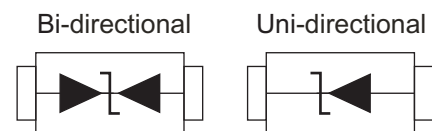

### Maximum Ratings and Electrical Characteristics

Rating at 25°C ambient temperature unless otherwise specified.  
Single phase, half wave, 60Hz, resistive or inductive load.  
For capacitive load, derate current by 20%.

Characteristics	Symbol	Value	Units
Peak power dissipation with a 10/1000 $\mu$ s waveform (Note 1)	P <sub>PP</sub>	3000	W
Peak pulse current with a 10/1000 $\mu$ s waveform (Note 1)	I <sub>PP</sub>	See Next Table	A
Power dissipation on infinite heatsink at T <sub>L</sub> =75°C	P <sub>D</sub>	6.0	W
Peak forward surge current, 8.3ms single half sine-wave unidirectional only (Note 2)	I <sub>FSM</sub>	300	A
Maximum instantaneous forward voltage at 100A for unidirectional only (Note 3)	V <sub>F</sub>	3.5/5.0	V
Operation junction and storage temperature range	T <sub>J</sub> , T <sub>STG</sub>	-55 to +150	°C

- Notes: 1. Non-repetitive current pulse, per Fig.5 and derated above T<sub>A</sub>=25°C, per Fig.1  
2. Measured on 8.3 ms single half sine-wave or equivalent square wave, duty cycle = 4 pulses per minute maximum.  
3. V<sub>F</sub><3.5V for devices of V<sub>BR</sub><200V and V<sub>F</sub><5.0V for devices of V<sub>BR</sub>>201V

Company reserves the right to improve product design , functions and reliability without notice.

REV: C

## RATING AND CHARACTERISTIC CURVES (ATV30C5V0-HF Thru. ATV30C441-HF)

Fig.1 - Pulse Derating Curve

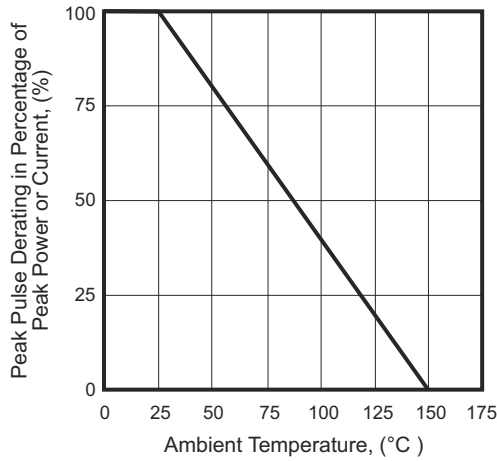

Fig.2 - Max. Non-Repetitive Surge Current

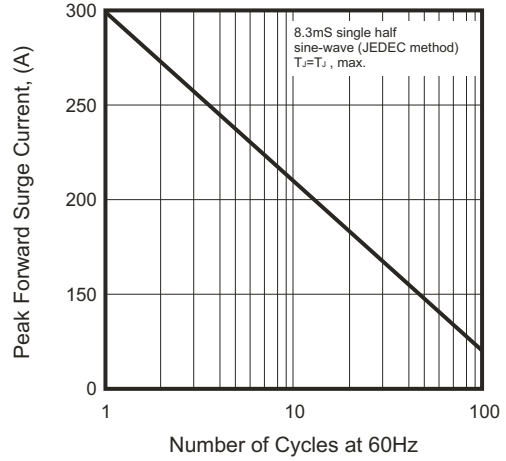

Fig.3 - Steady State Power Derating Curve

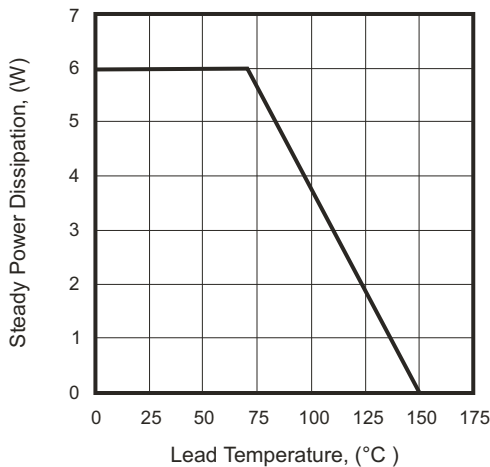

Fig.4 - Peak Pulse Power Rating Curve

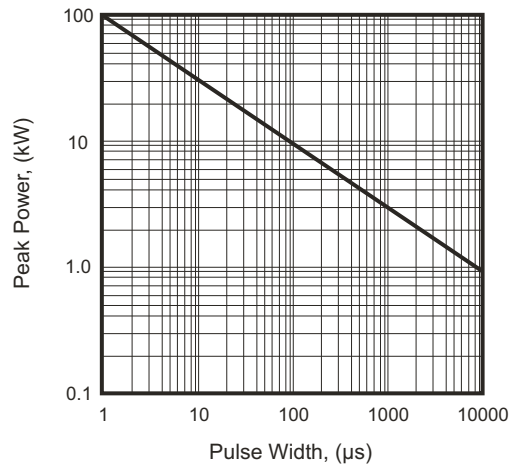

Fig.5 - Pulse Waveform

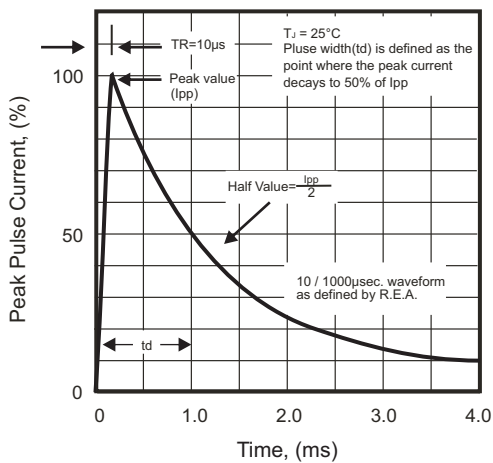
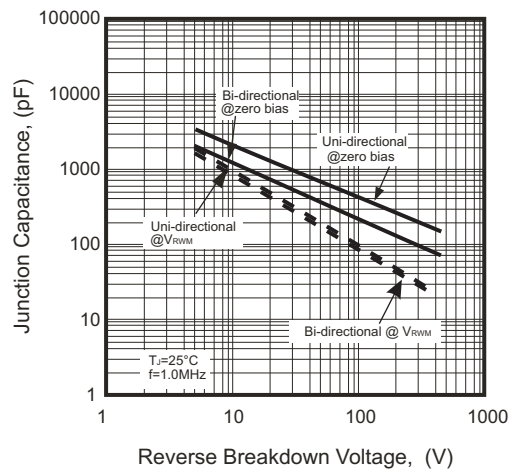

Fig.6 - Typical Junction Capacitance



# SMD Transient Voltage Suppressor



## Electrical Characteristics (ATV30C5V0-HF Thru. ATV30C441-HF)

Part No.	Breakdown voltage V <sub>BR</sub> @ I <sub>T</sub>			Maximum Reverse Leakage @V <sub>RWM</sub> I <sub>R</sub> (uA)	Working Peak Reverse Voltage V <sub>RWM</sub> (V)	Maximum Reverse Surge Current I <sub>PP</sub> (A)	Maximum Clamping Voltage @I <sub>PP</sub> V <sub>C</sub> (V)	Device Marking Code	
	Min. (V)	Max. (V)	I <sub>T</sub> (mA)					UNI	BI
ATV30C5V0J(B)-HF	6.40	7.00	50	800	5.0	326.09	9.2	RDE	DDE
ATV30C6V0J(B)-HF	6.67	7.37	50	800	6.0	291.26	10.3	RDG	DDG
ATV30C6V5J(B)-HF	7.22	7.98	50	500	6.5	267.86	11.2	RDK	DDK
ATV30C7V0J(B)-HF	7.78	8.60	50	200	7.0	250.00	12.0	PDM	DDM
ATV30C7V5J(B)-HF	8.33	9.21	5	100	7.5	232.56	12.9	PDP	DDP
ATV30C8V0J(B)-HF	8.89	9.83	5	50	8.0	220.59	13.6	PDR	DDR
ATV30C8V5J(B)-HF	9.44	10.40	5	20	8.5	208.33	14.4	PDT	DDT
ATV30C9V0J(B)-HF	10.00	11.10	5	10	9.0	194.81	15.4	PDV	DDV
ATV30C100J(B)-HF	11.10	12.30	5	5	10.0	176.47	17.0	PDX	DDX
ATV30C110J(B)-HF	12.20	13.50	5	2	11.0	164.84	18.2	PDZ	DDZ
ATV30C120J(B)-HF	13.30	14.70	5	2	12.0	150.75	19.9	PEE	DEE
ATV30C130J(B)-HF	14.40	15.90	5	2	13.0	139.53	21.5	PEG	DEG
ATV30C140J(B)-HF	15.60	17.20	5	2	14.0	129.31	23.2	PEK	DEK
ATV30C150J(B)-HF	16.70	18.50	5	2	15.0	122.95	24.4	PEM	DEM
ATV30C160J(B)-HF	17.80	19.70	5	2	16.0	115.38	26.0	PEP	DEP
ATV30C170J(B)-HF	18.90	20.90	5	2	17.0	108.70	27.6	PER	DER
ATV30C180J(B)-HF	20.00	22.10	5	2	18.0	102.74	29.2	PET	DET
ATV30C190J(B)-HF	21.10	23.30	5	2	19.0	97.47	30.8	PEB	DEB
ATV30C200J(B)-HF	22.20	24.50	5	2	20.0	92.59	32.4	PEV	DEV
ATV30C220J(B)-HF	24.40	26.90	5	2	22.0	84.51	35.5	PEX	DEX
ATV30C240J(B)-HF	26.70	29.50	5	2	24.0	77.12	38.9	PEZ	DEZ
ATV30C260J(B)-HF	28.90	31.90	5	2	26.0	71.26	42.1	PFE	DFE
ATV30C280J(B)-HF	31.10	34.40	5	2	28.0	66.08	45.4	PFG	DFG
ATV30C300J(B)-HF	33.30	36.80	5	2	30.0	61.98	48.4	PFK	DFK
ATV30C330J(B)-HF	36.70	40.60	5	2	33.0	56.29	53.3	PFM	DFM
ATV30C360J(B)-HF	40.00	44.20	5	2	36.0	51.64	58.1	PFP	DFP
ATV30C400J(B)-HF	44.40	49.10	5	2	40.0	46.51	64.5	PFR	DFR
ATV30C430J(B)-HF	47.80	52.80	5	2	43.0	43.23	69.4	PFT	DFT
ATV30C450J(B)-HF	50.00	55.30	5	2	45.0	41.27	72.7	PFV	DFV
ATV30C480J(B)-HF	53.30	58.90	5	2	48.0	38.76	77.4	PFX	DFX
ATV30C510J(B)-HF	56.70	62.70	5	2	51.0	36.41	82.4	PFZ	DFZ
ATV30C540J(B)-HF	60.00	66.30	5	2	54.0	34.44	87.1	RGE	DGE
ATV30C580J(B)-HF	64.40	71.20	5	2	58.0	32.05	93.6	PGG	DGG
ATV30C600J(B)-HF	66.70	73.70	5	2	60.0	30.99	96.8	PGK	DGK
ATV30C640J(B)-HF	71.10	78.60	5	2	64.0	29.13	103.0	PGM	DGM
ATV30C700J(B)-HF	77.80	86.00	5	2	70.0	26.55	113.0	PGP	DGP
ATV30C750J(B)-HF	83.30	92.10	5	2	75.0	24.79	121.0	PGR	DGR
ATV30C780J(B)-HF	86.70	95.80	5	2	78.0	23.81	126.0	PGT	DGT
ATV30C800J(B)-HF	88.80	97.60	5	2	80.0	23.15	129.6	PGB	DGB
ATV30C850J(B)-HF	94.40	104.00	5	2	85.0	21.90	137.0	PGV	DGV
ATV30C900J(B)-HF	100.00	111.00	5	2	90.0	20.55	146.0	PGX	DGX
ATV30C101J(B)-HF	111.00	123.00	5	2	100.0	18.52	162.0	PGZ	DGZ
ATV30C111J(B)-HF	122.00	135.00	5	2	110.0	16.95	177.0	PHE	DHE
ATV30C121J(B)-HF	133.00	147.00	5	2	120.0	15.54	193.0	PHG	DHG

Company reserves the right to improve product design , functions and reliability without notice.

REV: C

# SMD Transient Voltage Suppressor

## Electrical Characteristics (ATV30C5V0-HF Thru. ATV30C441-HF)

Part No.	Breakdown voltage V <sub>BR</sub> @ I <sub>T</sub>			Maximum Reverse Leakage @V <sub>RWM</sub> I <sub>R</sub> (uA)	Working Peak Reverse Voltage V <sub>RWM</sub> (V)	Maximum Reverse Surge Current I <sub>PP</sub> (A)	Maximum Clamping Voltage @I <sub>PP</sub> V <sub>C</sub> (V)	Device Marking Code	
	Min. (V)	Max. (V)	I <sub>T</sub> (mA)					UNI	BI
ATV30C131J(B)-HF	144.0	159.0	5	2	130.0	14.35	209.0	PHK	DHK
ATV30C141J(B)-HF	155.0	171.0	5	2	140.0	13.23	226.8	PHB	DHB
ATV30C151J(B)-HF	167.0	185.0	5	2	150.0	12.35	243.0	PHM	DHM
ATV30C161J(B)-HF	178.0	197.0	5	2	160.0	11.58	259.0	PHP	DHP
ATV30C171J(B)-HF	189.0	209.0	5	2	170.0	10.91	275.0	PHR	DHR
ATV30C181J(B)-HF	200.0	220.0	5	2	180.0	10.29	291.6	PHT	DHT
ATV30C191J(B)-HF	211.0	232.0	5	2	190.0	9.75	307.8	PHV	DHV
ATV30C201J(B)-HF	224.0	247.0	5	2	200.0	9.26	324.0	PHW	DHW
ATV30C221J(B)-HF	246.0	272.0	5	2	220.0	8.43	356.0	PHX	DHX
ATV30C251J(B)-HF	279.0	309.0	5	2	250.0	7.41	405.0	PHZ	DHZ
ATV30C301J(B)-HF	335.0	371.0	5	2	300.0	6.17	486.0	PJE	DJE
ATV30C351J(B)-HF	391.0	432.0	5	2	350.0	5.29	567.0	PJG	DJG
ATV30C401J(B)-HF	447.0	494.0	5	2	400.0	4.63	648.0	PJK	DJK
ATV30C441J(B)-HF	492.0	543.0	5	2	440.0	4.21	713.0	PJM	DJM

Note:

- 1) Suffix J denotes 5% tolerance devices.
- 2) Suffix B after part number to specify Bi-directional devices.
- 3) For Bi-Directional devices having V<sub>R</sub> of 10 volts and under, the I<sub>R</sub> limit is double.

## Reel Taping Specification

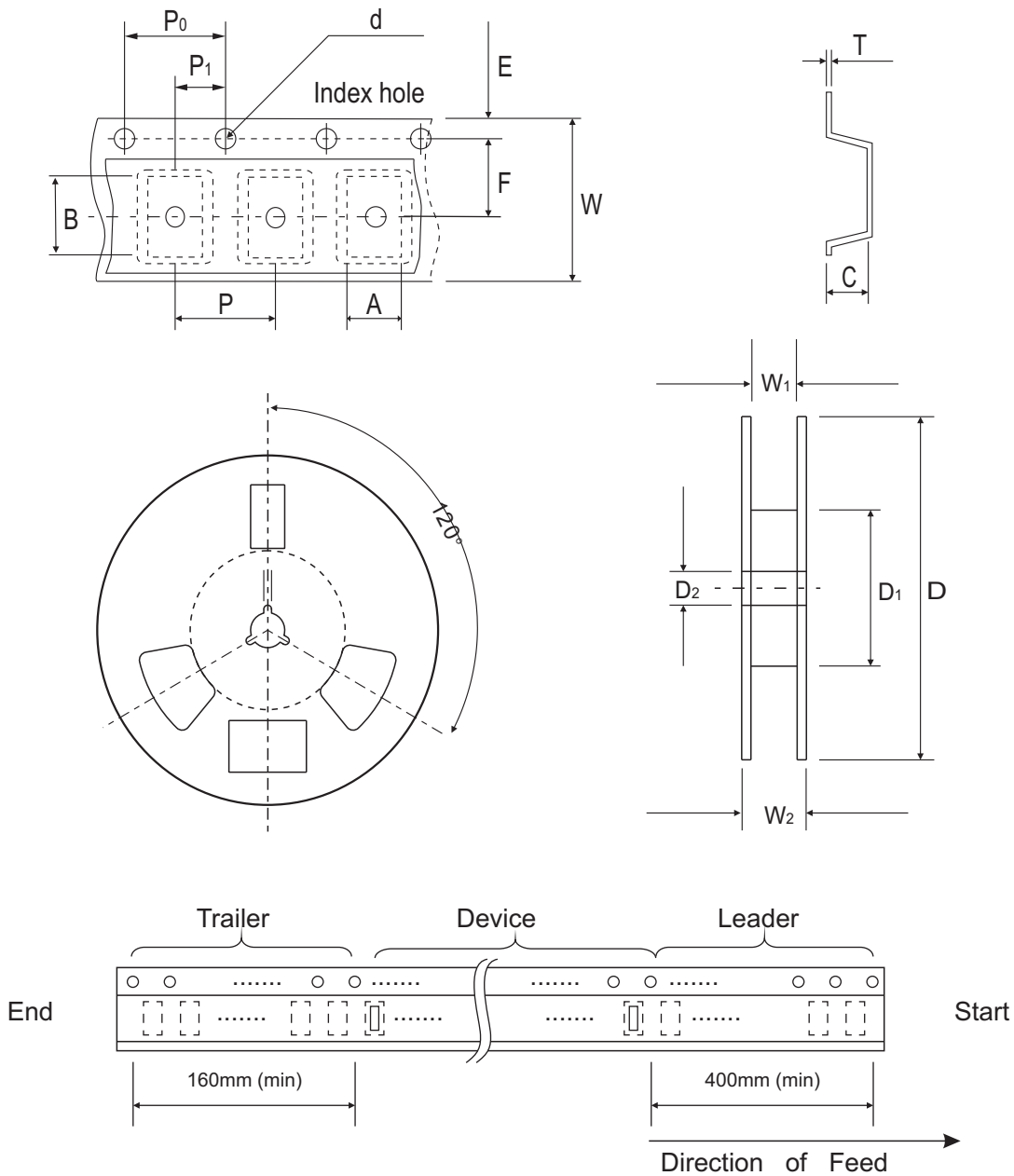

DO-214AB (SMC)	SYMBOL	A	B	C	d	T	D	D <sub>1</sub>	D <sub>2</sub>
	(mm)	See Note 1			1.55 ± 0.05	0.40 (Max.)	330.00	50.00 (Min.)	13.00 <sup>+0.50</sup> <sub>-0.20</sub>
	(inch)	See Note 1			0.061 ± 0.002	0.016 (Max.)	13.000	1.969 (Min.)	0.512 <sup>+0.020</sup> <sub>-0.008</sub>
DO-214AB (SMC)	SYMBOL	E	F	P	P <sub>0</sub>	P <sub>1</sub>	W	W <sub>1</sub>	W <sub>2</sub>
	(mm)	1.75 ± 0.10	7.50 ± 0.05	8.00 ± 0.10	4.00 ± 0.10	2.00 ± 0.05	16.00 ± 0.10	16.40 <sup>+2.00</sup> <sub>-0.00</sub>	22.40 (Max.)
	(inch)	0.069 ± 0.004	0.295 ± 0.002	0.315 ± 0.004	0.157 ± 0.004	0.079 ± 0.002	0.630 ± 0.004	0.646 <sup>+0.079</sup> <sub>-0.000</sub>	0.882 (Max.)

Notes: 1. A, B, and C the clearance between the component and the cavity must be within 0.5 mm max. for 8 mm tape and 12 mm tape, 1.0 mm max. for 16mm tape and 24 mm tape.

Company reserves the right to improve product design , functions and reliability without notice.

REV: C

## Marking Code

1. **C**: COMCHIP

2. ○: Package

○	PKG
A	SMA
B	SMB
C	SMC

3. XXX: Marking code (see Page. 3~4)

4. : Cathod Band

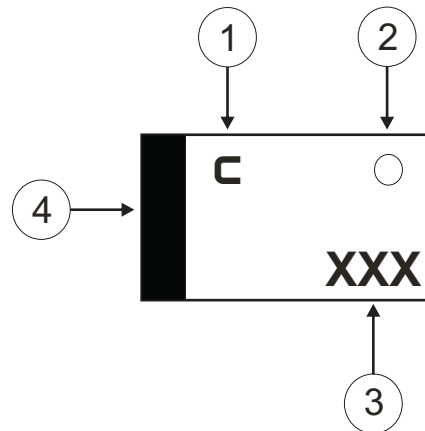

## Suggested PAD Layout

SIZE	DO-214AB(SMC)	
	(mm)	(inch)
A	8.13	0.320
B	4.69 MAX	0.185 MAX
C	1.52 MIN	0.060 MIN
D	3.20 MIN	0.126 MIN

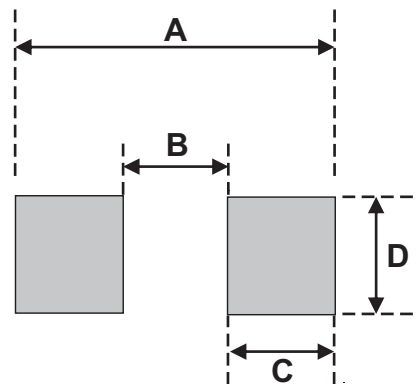



## Standard Packaging

Case Type	REEL PACK	
	REEL ( pcs )	Reel Size (inch)
DO-214AB (SMC)	3,000	13

## Looking for pricing, stock, or lifecycle information?

Click below to explore more details on WIN SOURCE:

-  [View ATV30C301J-HF on WIN SOURCE](#)
-  [Comchip Technology Information](#)

## Optimize Your Supply Chain with WIN SOURCE Solutions

-  Global Sourcing Solution
-  Obsolete Management
-  Cost Control Management
-  Shortage Management
-  Alternative Solution
-  Excess Inventory Management