



Features

- Logic Level Input
- Input Protection (ESD)
- Thermal shutdown with auto restart
- Green product (RoHS compliant)
- Overload protection
- Short circuit protection
- Overvoltage protection
- Current limitation
- Analog driving possible

Product Summary

Drain source voltage	V_{DS}	42	V
On-state resistance	$R_{DS(on)}$	50	m Ω
Nominal load current	$I_{D(Nom)}$	3	A
Clamping energy	E_{AS}	500	mJ

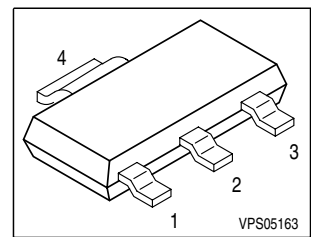

Application

- All kinds of resistive, inductive and capacitive loads in switching or linear applications
- μ C compatible power switch for 12 V DC applications
- Replaces electromechanical relays and discrete circuits

General Description

N channel vertical power FET in Smart SIPMOS[®] technology. Fully protected by embedded protection functions.

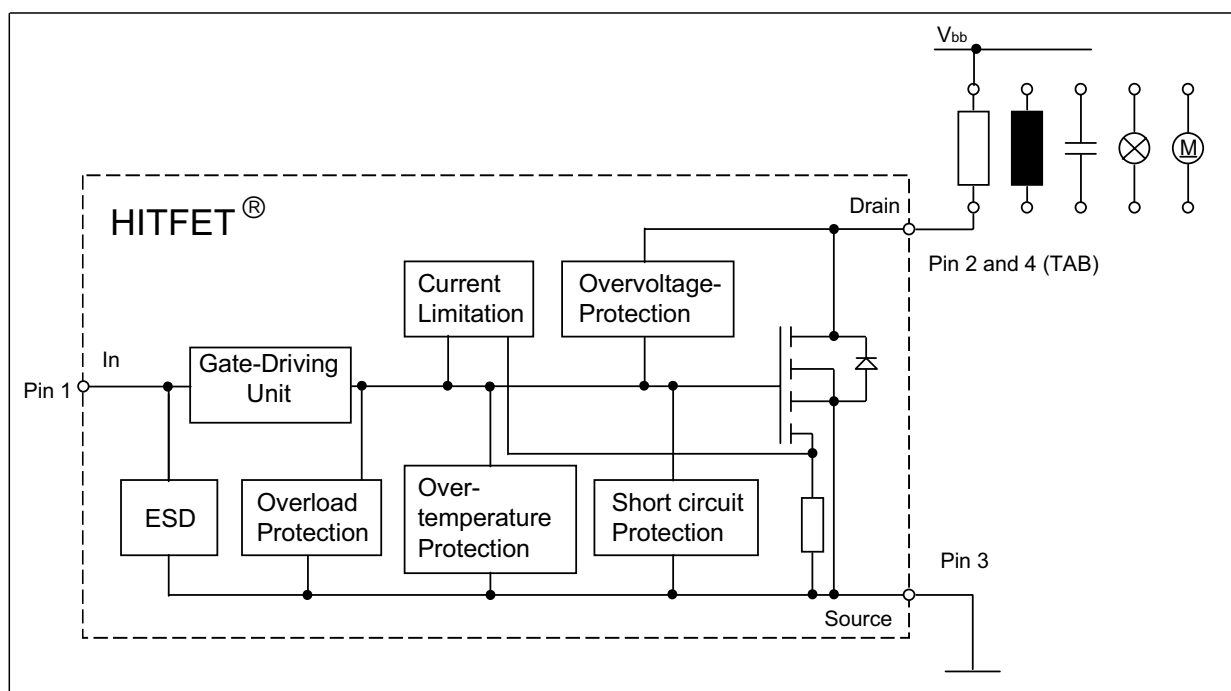

Complete product spectrum and additional information <http://www.infineon.com/hitfet>

Maximum Ratings at $T_j = 25^\circ\text{C}$, unless otherwise specified

Parameter	Symbol	Value	Unit
Drain source voltage	V_{DS}	42	V
Supply voltage for full short circuit protection	$V_{bb(SC)}$	42	
Continuous input voltage ¹⁾	V_{IN}	-0.2 ²⁾ ... +10	
Continuous input current ²⁾ -0.2V $\leq V_{IN} \leq$ 10V $V_{IN} < -0.2\text{V}$ or $V_{IN} > 10\text{V}$	I_{IN}	self limited $ I_{IN} \leq 2$	mA
Operating temperature	T_j	-40 ... +150	$^\circ\text{C}$
Storage temperature	T_{stg}	-55 ... +150	
Power dissipation ⁵⁾ $T_C = 85^\circ\text{C}$	P_{tot}	3.8	W
Unclamped single pulse inductive energy ²⁾	E_{AS}	500	mJ
Load dump protection $V_{LoadDump}^{2)3)} = V_A + V_S$ $V_{IN} = 0$ and 10 V, $t_d = 400$ ms, $R_l = 2 \Omega$, $R_L = 4.5 \Omega$, $V_A = 13.5$ V	V_{LD}	53.5	V
Electrostatic discharge voltage ²⁾ (Human Body Model) according to Jedec norm EIA/JESD22-A114-B, Section 4	V_{ESD}	2	kV

Thermal resistance

junction - ambient: @ min. footprint @ 6 cm ² cooling area ⁴⁾	R_{thJA}	125 72	K/W
junction-soldering point:	R_{thJS}	17	K/W

¹For input voltages beyond these limits I_{IN} has to be limited.

²not subject to production test, specified by design

³ $V_{Loaddump}$ is setup without the DUT connected to the generator per ISO 7637-1 and DIN 40839

⁴ Device on 50mm*50mm*1.5mm epoxy PCB FR4 with 6cm² (one layer, 70 μm thick) copper area for drain connection. PCB mounted vertical without blown air.

⁵not subject to production test, calculated by R_{thJA} and $R_{ds(on)}$

Electrical Characteristics

Parameter at $T_j = 25^\circ\text{C}$, unless otherwise specified	Symbol	Values			Unit
		min.	typ.	max.	
Characteristics					
Drain source clamp voltage $T_j = -40 \dots +150$, $I_D = 10 \text{ mA}$	$V_{DS(AZ)}$	42	-	55	V
Off-state drain current $T_j = -40 \dots +85^\circ\text{C}$, $V_{DS} = 32 \text{ V}$, $V_{IN} = 0 \text{ V}$ $T_j = 150^\circ\text{C}$	I_{DSS}	- -	1.5 5	8 15	μA
Input threshold voltage $I_D = 1.4 \text{ mA}$, $T_j = 25^\circ\text{C}$ $I_D = 1.4 \text{ mA}$, $T_j = 150^\circ\text{C}$	$V_{IN(th)}$	1.3 0.8	1.7 -	2.2 -	V
On state input current	$I_{IN(on)}$	-	10	30	μA
On-state resistance $V_{IN} = 5 \text{ V}$, $I_D = 3 \text{ A}$, $T_j = 25^\circ\text{C}$ $V_{IN} = 5 \text{ V}$, $I_D = 3 \text{ A}$, $T_j = 150^\circ\text{C}$	$R_{DS(on)}$	- -	45 75	60 100	$\text{m}\Omega$
On-state resistance $V_{IN} = 10 \text{ V}$, $I_D = 3 \text{ A}$, $T_j = 25^\circ\text{C}$ $V_{IN} = 10 \text{ V}$, $I_D = 3 \text{ A}$, $T_j = 150^\circ\text{C}$	$R_{DS(on)}$	- -	35 65	50 90	
Nominal load current ⁵⁾ $V_{DS} = 0.5 \text{ V}$, $T_j < 150^\circ\text{C}$, $V_{IN} = 10 \text{ V}$, $T_A = 85^\circ\text{C}$	$I_{D(Nom)}$	3	4	-	A
Current limit (active if $V_{DS} > 2.5 \text{ V}$) ¹⁾ $V_{IN} = 10 \text{ V}$, $V_{DS} = 12 \text{ V}$, $t_m = 200 \mu\text{s}$	$I_{D(lim)}$	18	24	30	

¹⁾Device switched on into existing short circuit (see diagram Determination of $I_{D(lim)}$). If the device is in on condition and a short circuit occurs, these values might be exceeded for max. 50 μs .

⁵⁾not subject to production test, calculated by R_{thJA} and $R_{ds(on)}$

Electrical Characteristics

Parameter at $T_j = 25^\circ\text{C}$, unless otherwise specified	Symbol	Values			Unit
		min.	typ.	max.	

Dynamic Characteristics

Turn-on time V_{IN} to 90% I_D : $R_L = 4.7 \Omega$, $V_{IN} = 0$ to 10 V, $V_{bb} = 12$ V	t_{on}	-	60	100	μs
Turn-off time V_{IN} to 10% I_D : $R_L = 4.7 \Omega$, $V_{IN} = 10$ to 0 V, $V_{bb} = 12$ V	t_{off}	-	60	100	
Slew rate on 70 to 50% V_{bb} : $R_L = 4.7 \Omega$, $V_{IN} = 0$ to 10 V, $V_{bb} = 12$ V	$-dV_{DS}/dt_{on}$	-	0.3	1.5	V/ μs
Slew rate off 50 to 70% V_{bb} : $R_L = 4.7 \Omega$, $V_{IN} = 10$ to 0 V, $V_{bb} = 12$ V	dV_{DS}/dt_{off}	-	0.7	1.5	

Protection Functions¹⁾

Thermal overload trip temperature	T_{jt}	150	175	-	$^\circ\text{C}$
Thermal hysteresis ²⁾	ΔT_{jt}	-	10	-	K
Input current protection mode $T_j = 150^\circ\text{C}$	$I_{IN(Prot)}$	-	130	300	μA
Unclamped single pulse inductive energy ²⁾ $I_D = 3$ A, $T_j = 25^\circ\text{C}$, $V_{bb} = 12$ V	E_{AS}	500	-	-	mJ

Inverse Diode

Inverse diode forward voltage $I_F = 15$ A, $t_m = 250 \mu\text{s}$, $V_{IN} = 0$ V, $t_P = 300 \mu\text{s}$	V_{SD}	-	1	1.5	V
---	----------	---	---	-----	---

¹⁾Integrated protection functions are designed to prevent IC destruction under fault conditions described in the data sheet. Fault conditions are considered as "outside" normal operating range. Protection functions are not designed for continuous repetitive operation.

²⁾not subject to production test, specified by design

Block diagram

Terms

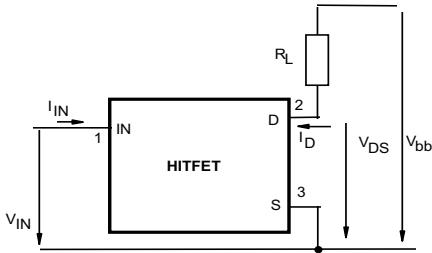

Inductive and overvoltage output clamp

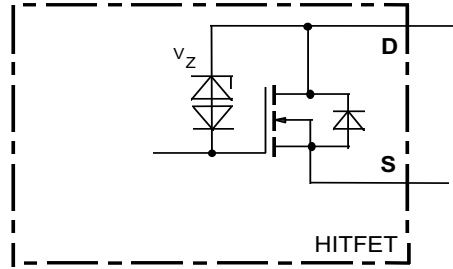

Input circuit (ESD protection)

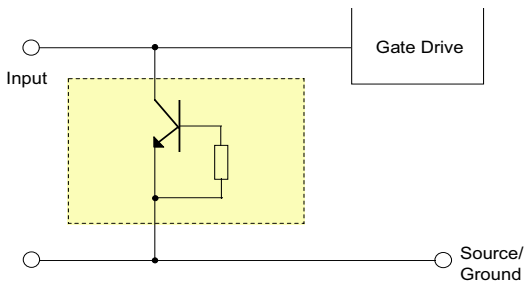

Short circuit behaviour

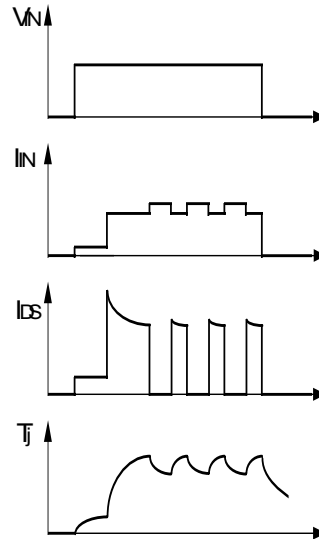

1 Maximum allowable power dissipation

$P_{tot} = f(T_S)$ resp.

$P_{tot} = f(T_A) @ R_{thJA} = 72 \text{ K/W}$

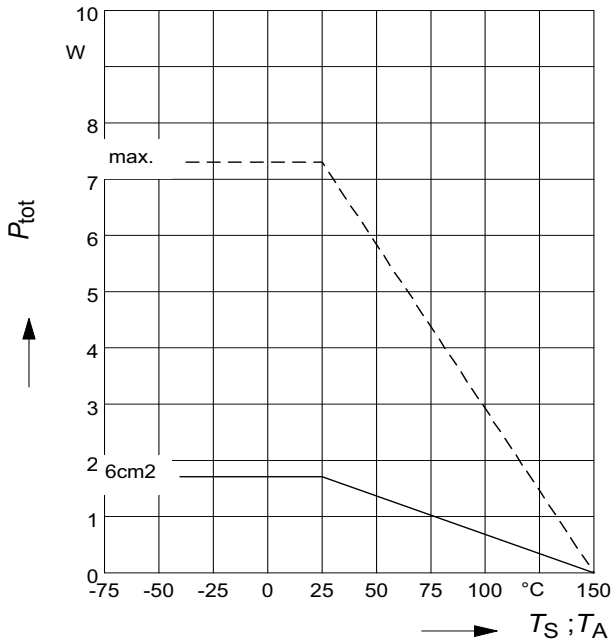

2 On-state resistance

$R_{ON} = f(T_j); I_D = 3A; V_{IN} = 10V$

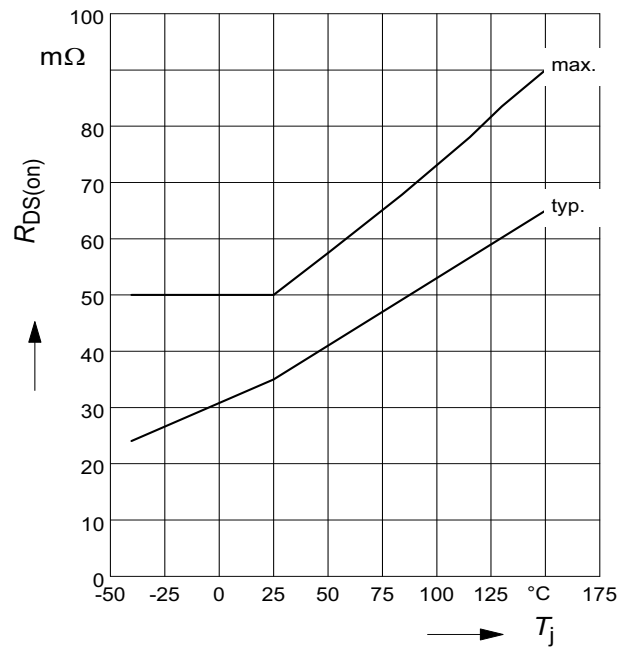

3 On-state resistance

$R_{ON} = f(T_j); I_D = 3A; V_{IN} = 5V$

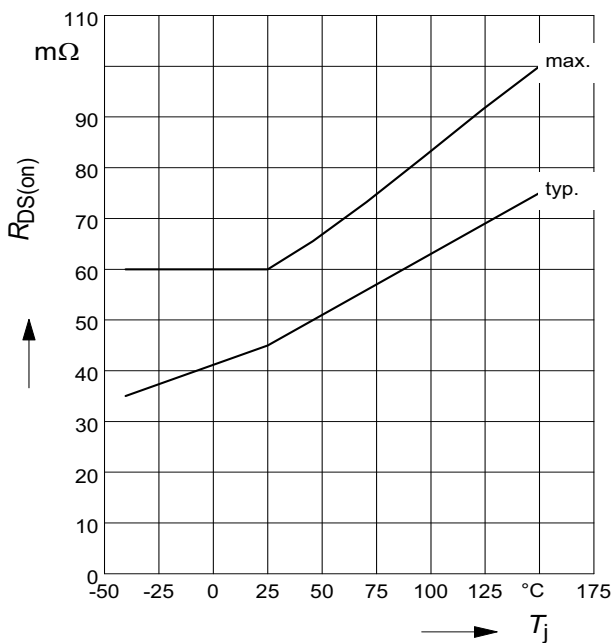

4 Typ. input threshold voltage

$V_{IN(th)} = f(T_j); I_D = 0.7 \text{ mA}; V_{DS} = 12V$

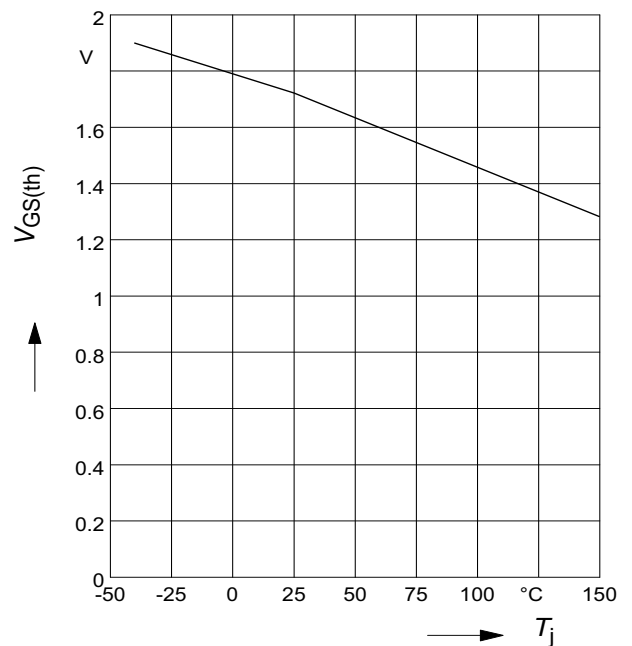

5 Typ. transfer characteristics

$I_D = f(V_{IN})$; $V_{DS} = 12V$; $T_{Jstart} = 25^\circ C$

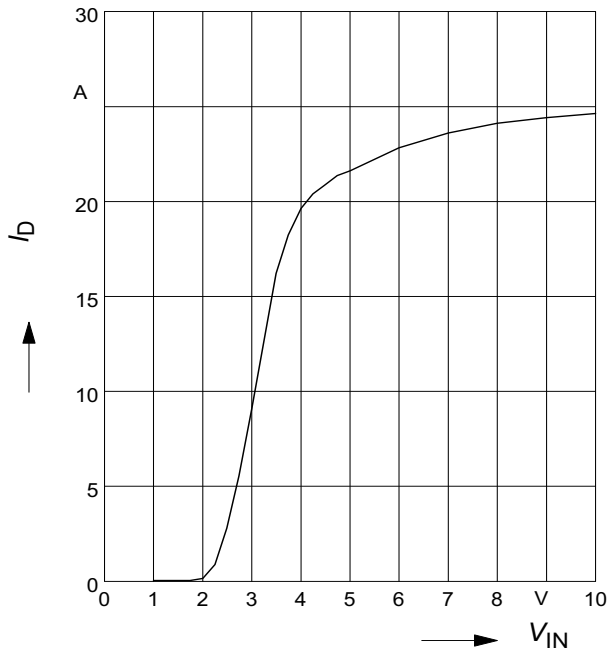

6 Typ. short circuit current

$I_{D(lim)} = f(T_j)$; $V_{DS} = 12V$

Parameter: V_{IN}

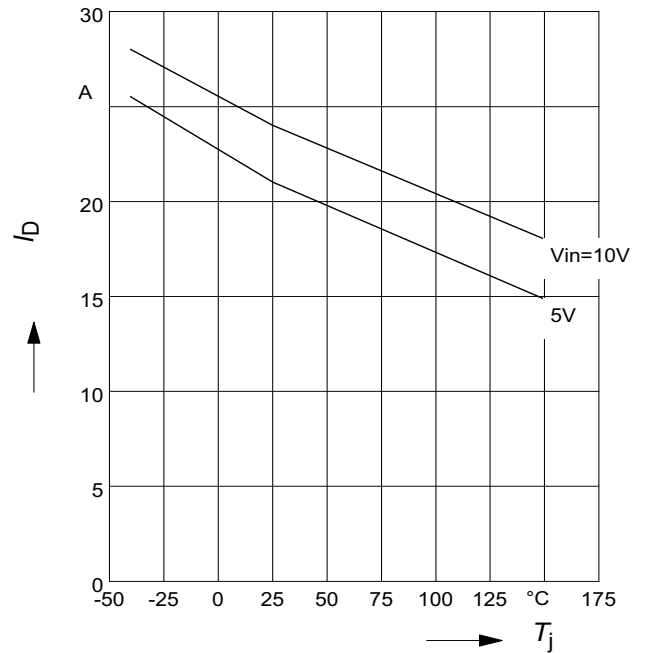

7 Typ. output characteristics

$I_D = f(V_{DS})$; $T_{Jstart} = 25^\circ C$

Parameter: V_{IN}

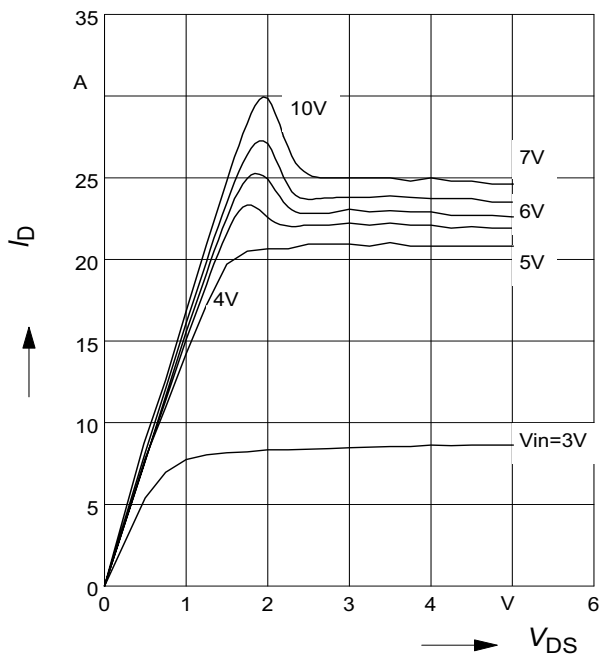

8 Off-state drain current

$I_{DSS} = f(T_j)$

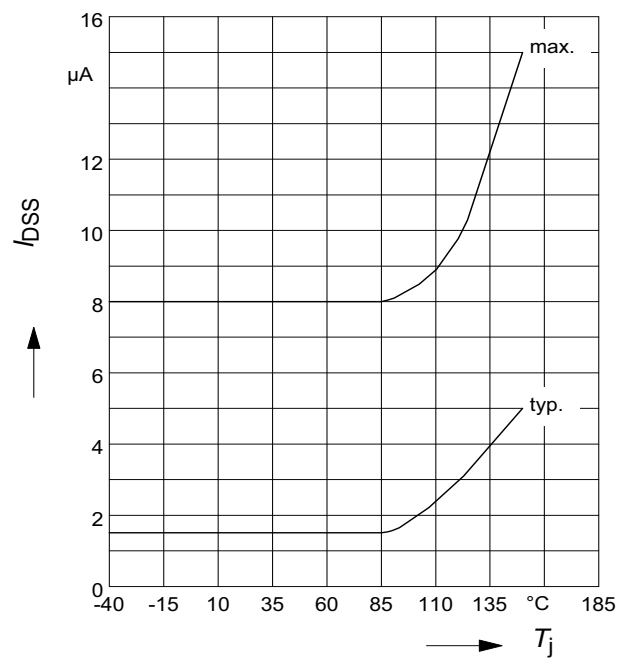

9 Typ. overload current

$I_{D(lim)} = f(t)$, $V_{bb}=12\text{ V}$, no heatsink

Parameter: T_{jstart}

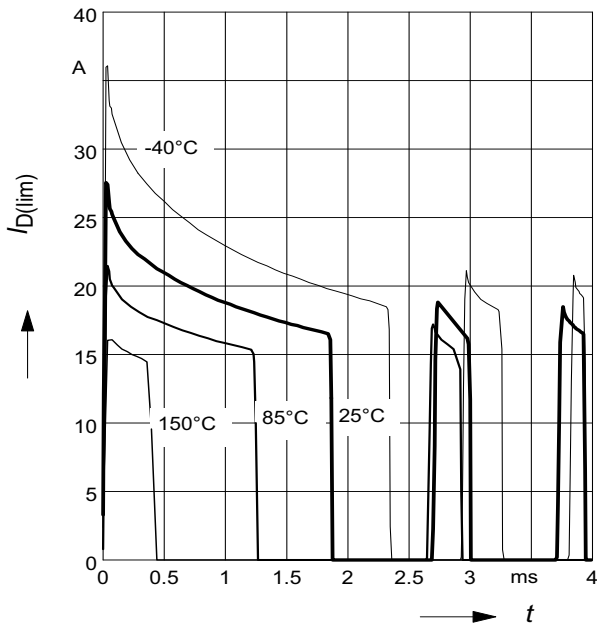

10 Typ. transient thermal impedance

$Z_{thJA}=f(t_p)$ @ 6 cm^2 cooling area

Parameter: $D=t_p/T$

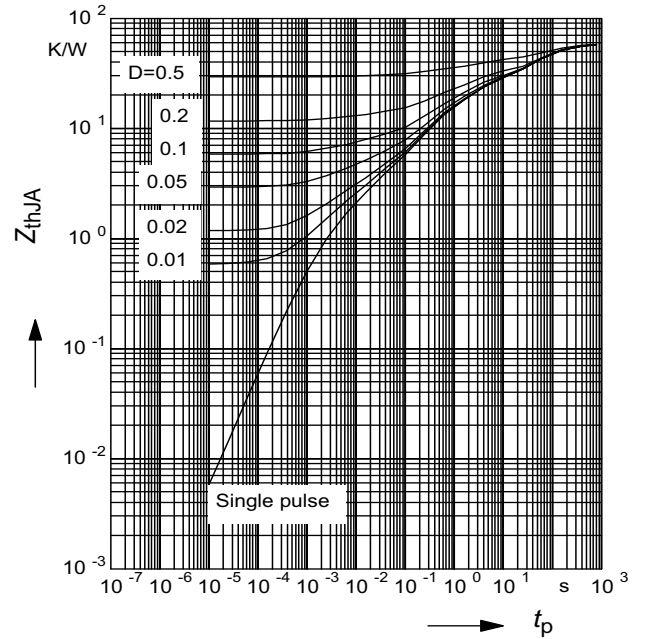

11 Determination of $I_{D(lim)}$

$I_{D(lim)} = f(t)$; $t_m = 200\mu\text{s}$

Parameter: T_{jstart}

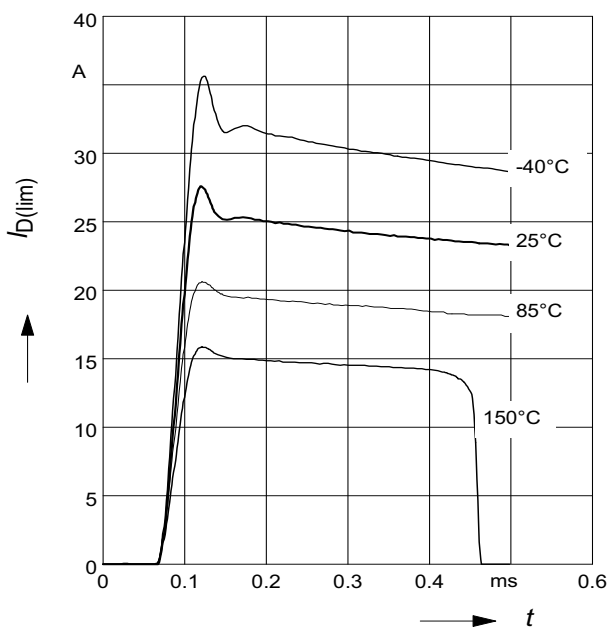

1 Package Outlines

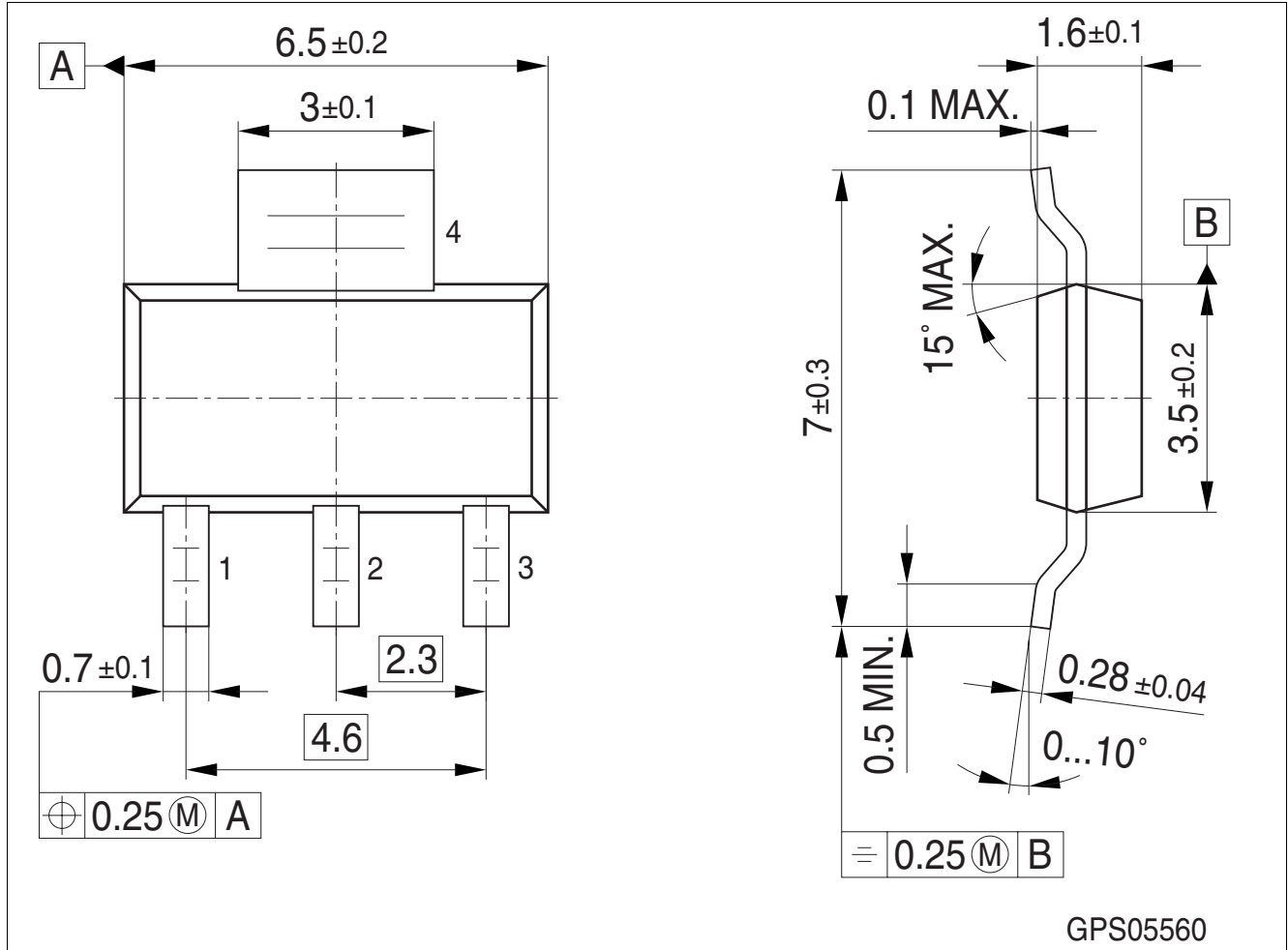

Figure 1 PG-SOT223-4 (Plastic Green Small Outline Transistor Package)

Green Product (RoHS compliant)

To meet the world-wide customer requirements for environmentally friendly products and to be compliant with government regulations the device is available as a green product. Green products are RoHS-Compliant (i.e. Pb-free finish on leads and suitable for Pb-free soldering according to IPC/JEDEC J-STD-020).

Please specify the package needed (e.g. green package) when placing an order

You can find all of our packages, sorts of packing and others in our Infineon Internet Page "Products": <http://www.infineon.com/products>.

Dimensions in mm

2 Revision History

Version	Date	Changes
Rev. 1.3	2008-04-14	Package information updated to SOT223-4
Rev. 1.2	2007-02-15	released automotive green version Package parameter (humidity and climatic) removed in Maximum ratings AEC icon added RoHS icon added Green product (RoHS-compliant) added to the feature list Package information updated to green Green explanation added
Rev. 1.1	2004-03-05	released production version

Edition 2008-04-14

**Published by
Infineon Technologies AG
81726 Munich, Germany**

**© Infineon Technologies AG 2008.
All Rights Reserved.**

Legal Disclaimer

The information given in this document shall in no event be regarded as a guarantee of conditions or characteristics ("Beschaffenhheitsgarantie"). With respect to any examples or hints given herein, any typical values stated herein and/or any information regarding the application of the device, Infineon Technologies hereby disclaims any and all warranties and liabilities of any kind, including without limitation warranties of non-infringement of intellectual property rights of any third party.

Information

For further information on technology, delivery terms and conditions and prices please contact your nearest Infineon Technologies Office (www.infineon.com).



Warnings

Due to technical requirements components may contain dangerous substances. For information on the types in question please contact your nearest Infineon Technologies Office.

Infineon Technologies Components may only be used in life-support devices or systems with the express written approval of Infineon Technologies, if a failure of such components can reasonably be expected to cause the failure of that life-support device or system, or to affect the safety or effectiveness of that device or system. Life support devices or systems are intended to be implanted in the human body, or to support and/or maintain and sustain and/or protect human life. If they fail, it is reasonable to assume that the health of the user or other persons may be endangered.

Looking for pricing, stock, or lifecycle information?

Click below to explore more details on WIN SOURCE:

-  [View BSP78HUMA1 on WIN SOURCE](#)
-  [Infineon Technologies Information](#)

Optimize Your Supply Chain with WIN SOURCE Solutions

-  Global Sourcing Solution
-  Obsolete Management
-  Cost Control Management
-  Shortage Management
-  Alternative Solution
-  Excess Inventory Management