



**THE DATASHEET OF
AS16AM10N-A**





Automation for a Changing World

Delta Compact Modular Mid-range PLC AS Series



www.deltaww.com



Flexible, Smart, Friendly - The Best Choice for a Controller of Automated Equipment

AS Series

The AS Series Compact Modular Mid-range PLC is a high performance multi-purpose controller designed for all kinds of automated equipment. It features Delta's self-developed 32-bit SoC CPUs for enhanced execution speed (40k steps/ms) and supports up to 32 extension modules or up to 1,024 inputs/outputs. The AS series provides accurate positioning control for up to 8 axes via CANopen motion network and 6 axes via pulse control (200 kHz). It is widely used in diverse automated equipment such as electronics manufacturing, labeling, food packaging, and textile machines.

The AS Series Controller is equipped with CANopen and EtherNet/IP network communication for high-speed data transmission. The professional yet simple editing software ISPSoft delivers quick hardware and network configuration with built-in function blocks for different industries. It also provides multi-layer password protection for enhanced system security.

The AS Series adopts a rackless design and patented DIN rail clips for fast vertical module installation. The simple shape and dark gray exterior of the AS series help resist stains and dirt in harsh industrial environments.





High Efficiency Computing

- Advanced CPU performance
- Optimized execution efficiency
- Optimized I/O update rate
- Permanent data backup, no battery required



Accurate Axis Control

- Delta CANopen positioning control
- Simple control instructions
- High-speed pulse positioning control
- High-speed counter



Simple Installation

- Easy installation process
- Convenient grounding protection
- Screwless installation procedure
- Loose-proof clip-type terminal block



Industrial Network Solution

- EtherNet/IP solution
- Remote I/O solution
- Serial communication solution



Programming and Diagnosis Functions

- Modular programming structure
- Convenient editing environment
- Easy hardware configuration and parameter setting
- Complete setting tools
- Multiple password protection



Models and Specifications

- Model name explanation
- CPU
- AS Series I/O modules
- High-density modules and accessories
- Dimensions
- Ordering information

High Efficiency Computing



Delta's self-developed AS Series CPU provides 32-bit high-performance computing. As the core of a high-efficiency controller, it helps increase productivity and adaptability to demanding equipment.



Advanced CPU Performance

■ High speed execution up to 40k steps/ms

(Condition: 40 % LD instruction/60% MOV instruction)

- Max. number of inputs/outputs: 1,024
- Program capacity: 128k steps
- Data registers: 60k words
- Max. extension ability: 32 modules

LD instruction 25 ns

MOV instruction 0.15 μ s

Floating point operation instruction 1.6 μ s

Trigonometric function instruction 3.5 μ s



Optimized Execution Efficiency

General Scanning Method

Standard simplex scanning which sequentially goes through instructions by fixed schedule operation (e.g. I/O update).

It significantly affects overall execution speed.

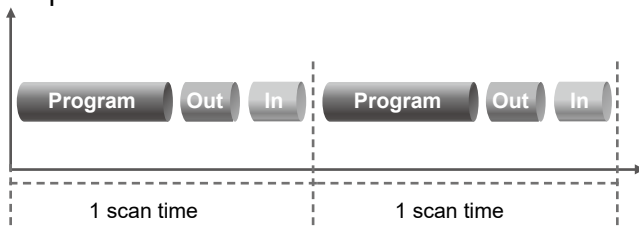

AS Series Scanning Method

Fixed schedule operations will be automatically processed by CPU background program when scanning starts. It significantly enhances execution speed.

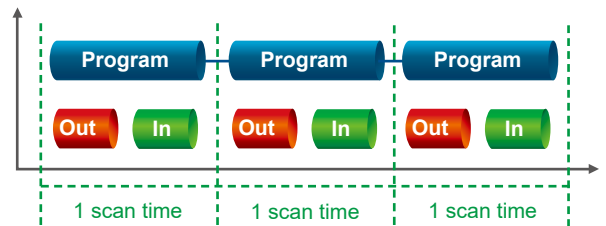

Optimized I/O updates

Common in the industry: PLC module bus update via serial communication

- General serial communication: the signal is sequentially sent from the 1st module to the last module. The more modules the longer I/O update time it takes.

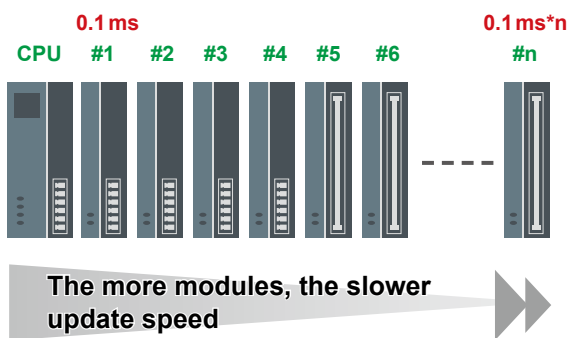

AS Series: PLC module bus update via parallel communication

- Industrial communication: the signal is sent via parallel communication. The I/O update time is not significantly prolonged even with more modules.

Industrial communication bus greatly enhances stability and speed.

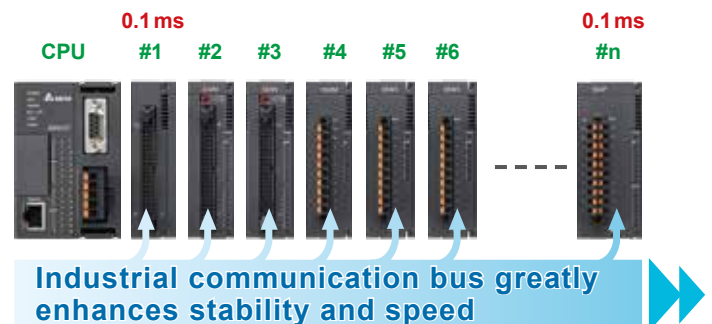

Note: The real updating performance will be different by different extension modules.

Permanent data backup, no battery required

Non-volatile memory material for data backup

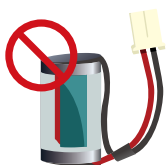

	PLC power off
PLC programs	permanent backup
Latched area	permanent backup

Lithium button battery for Real Time Clock (RTC) function



	PLC power off
RTC	keeps accurate time

Accurate Axis Control - Positioning Control Solution

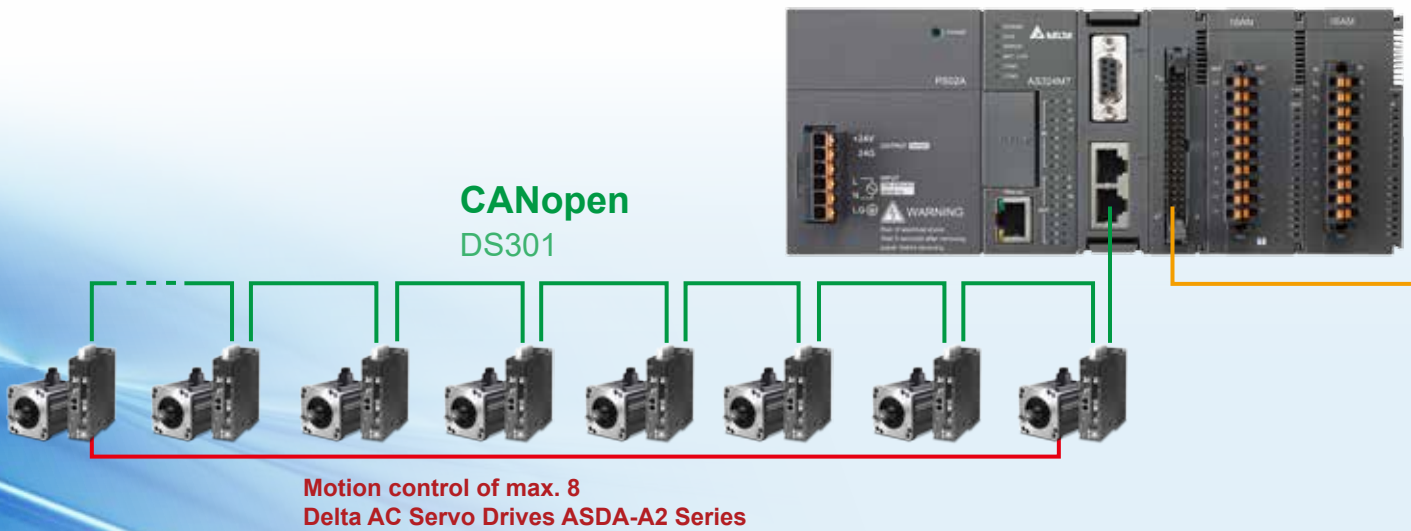

Positioning control - Delta's CANopen Control

- Delivers up to 8-axis CANopen positioning control with AS-FCOPM communication card
- Fast positioning configuration in one initialization instruction without building CANopen data exchange table
- Batch download programmable servo drive parameters avoids risk of loss
- Axis control by instructions provides easy maintenance and high PLC program readability

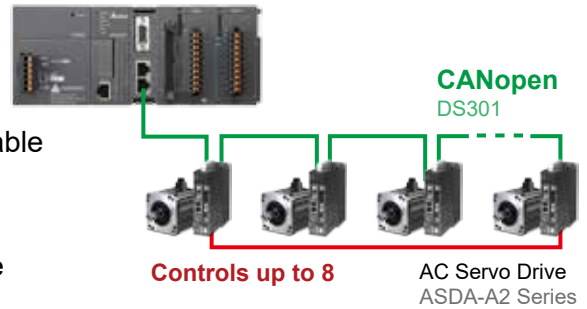

Simple control instructions for AC Servo Drive ASDA-A2 Series

- Initialization: INITC
- Relative positioning: DRVIC
- Read and write parameter: COPRW
- Acceleration and deceleration: CASD
- Constant speed control: PLSVC
- Absolute positioning: DRVAC
- Start/Stop: ASDON
- Homing: ZRNC

ASDA-A2 back and forth motion control in 4 steps

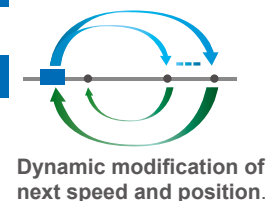
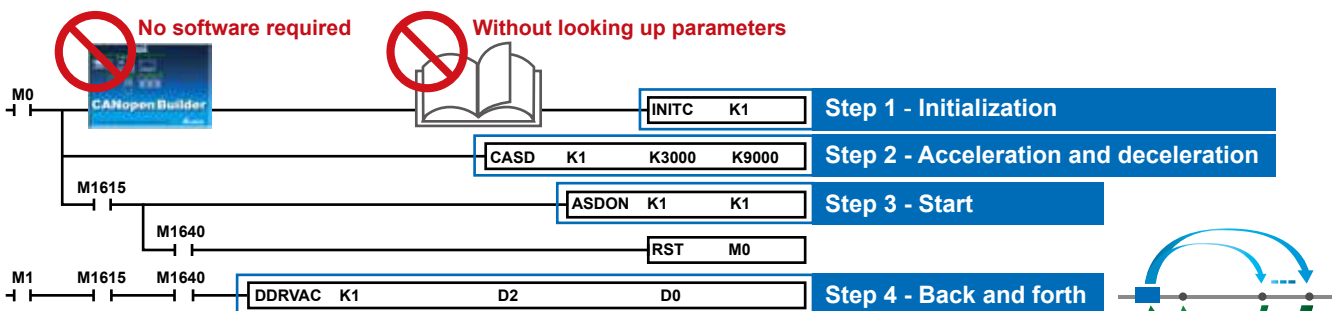

Pulse 



Motion control of max. 6
Delta AC Servo Drives ASDA-B2 Series

Positioning control - high-speed pulse

- AS332T-A/AS332P-A transistor CPU: 6 axes (or 12 channels) 200 kHz
- AS324MT-A differential CPU: 2 axes 4 MHz + 4 axes 200 kHz
- Supports positioning planning table for fast positioning planning and path simulation
- Choose any given 2 axes for linear and arc interpolation

* Note: Please refer to the product specification section (P.23) for more information on CPU models

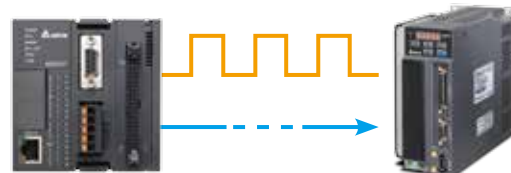

AC Servo Drive
ASDA-B2 Series

High-speed counter

- Real-time high precision monitoring:
AS332T-A/AS332P-A transistor CPU: 6 channels 200 kHz
AS324MT-A differential CPU: 2 channels 4 MHz/4 channels 200 kHz
- Up to 16 external input interrupts
- High-speed counter setting tools

* Note: Please refer to the product specification section (P.23) for more information on CPU models

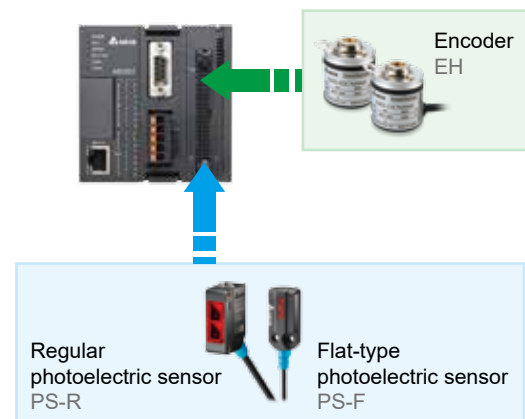
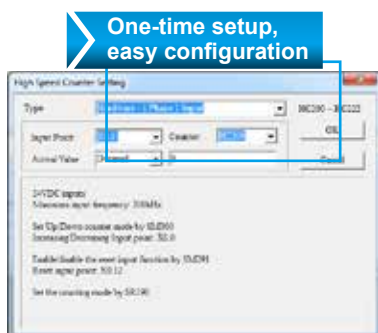

Simple Installation



■ Easy installation design

- Space-saving design suitable for installation in control panels

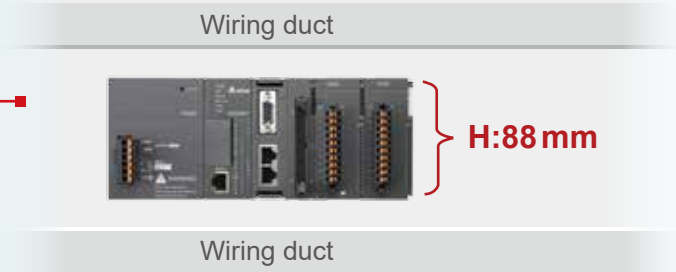
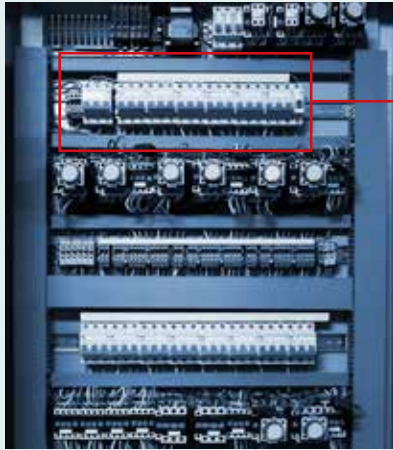

■ Rackless Din-rail installation

- Delta patented design

▶ Robust slot and clip interlocking design



■ Fast disassembly

- Release the clip ring to easily take out the module from the front without moving adjacent modules



■ Simple installation process

- Press the clip rings and push the module to the desired position until hearing a "click" to finish installation

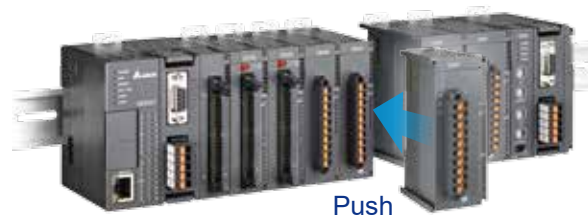

■ Convenient grounding protection

- Install on Din-rail: CPU module and expansion modules can be installed directly on Din-rail without backplane
- Install with screw: pull out the installation clip ring and directly install it on the panel
- Both methods are equipped with ground protection

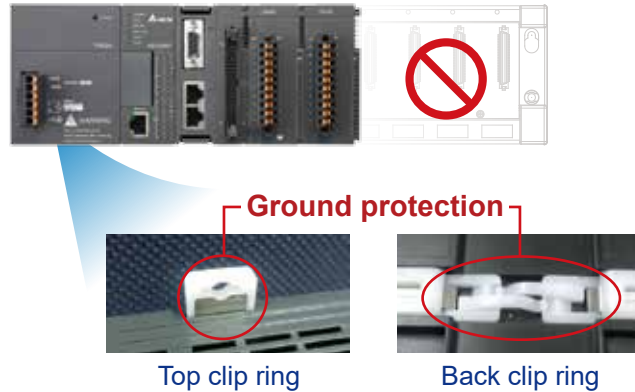

■ Screwless and time-saving installation

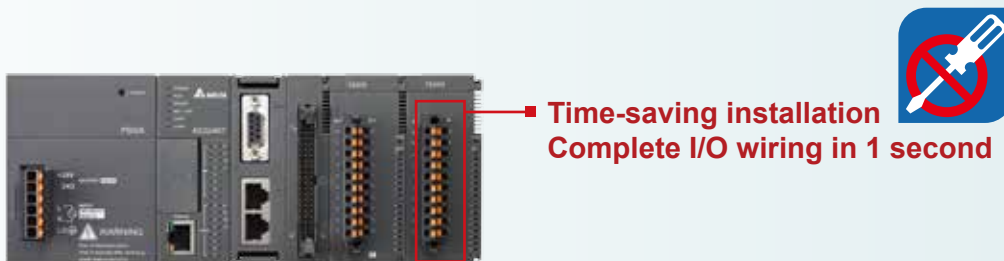

■ Robust Loose-proof spring clamp terminal block

- In commonly used spring clamp terminal blocks, the clamping force is determined by the spring material, which decreases with the aging of the spring.

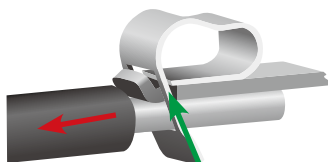

The green arrow is the clamping force, and the red arrow is the pull-out force.

- The AS Series adopts the full-covered spring clamp design that enhances the clamping force. When the wire is pulled-out (red arrow) and the spring moves up (green arrow), a downward force is generated (blue arrow) to clamp the wire.

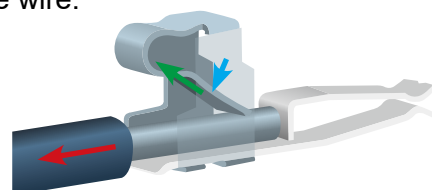

Industrial Network Solution

EtherNet/IP Solution

The open industrial Ethernet communication protocol for real-time control and data collection

EtherNet/IP[®]

- Max. connectable slave stations: 32
- Max. data transmission: 500 bytes/connection
- Performance: slave station data update in 1 scan time

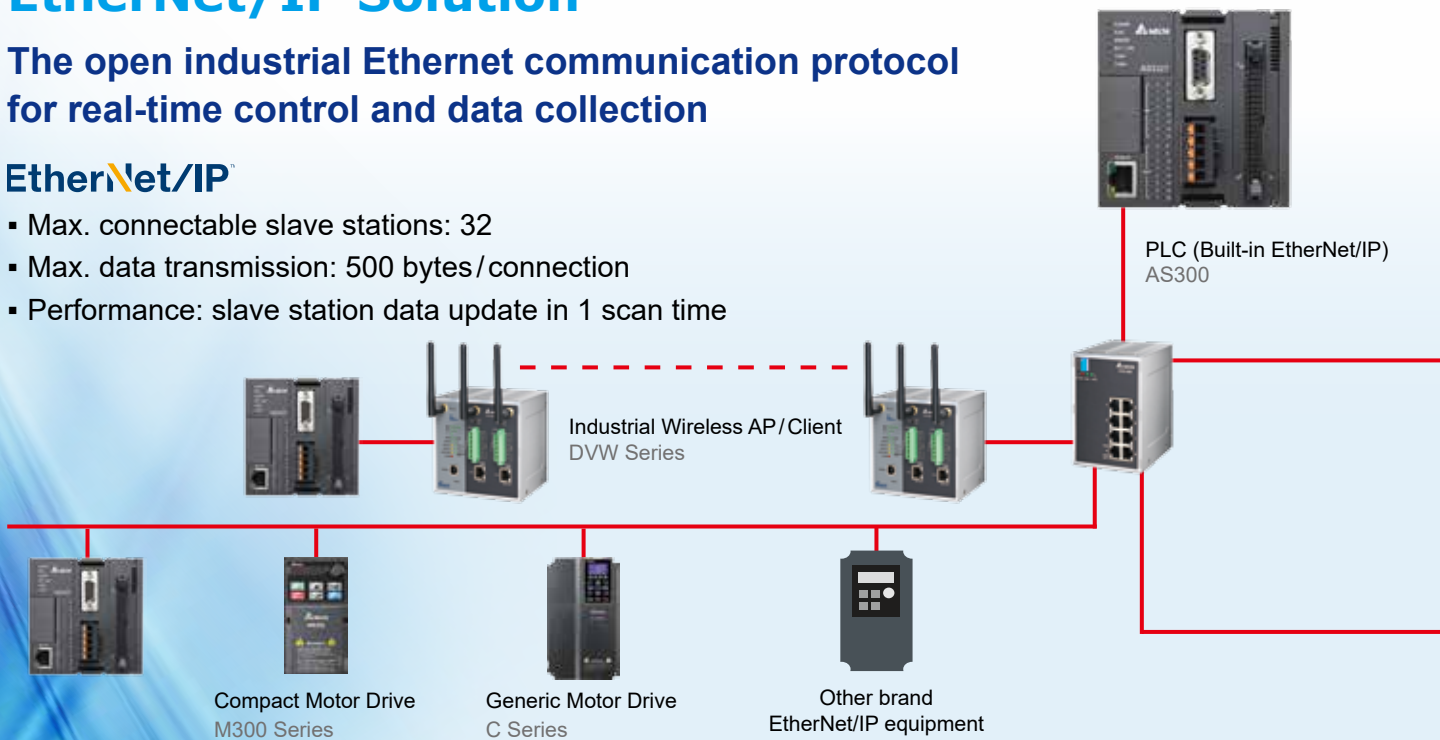

Flexible network system configuration

- Supports star, linear network topology for fast expansion and management on production lines
- Compatible with IT network. No independent network or IT technician required
- Combines with Delta IES solution to construct IoT for more automation applications and industrial 4.0 upgrades

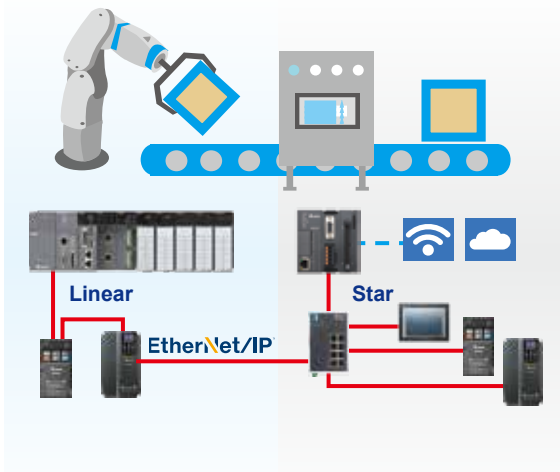

One cable, one network

- Complete Delta EtherNet/IP solution connects different equipment via Ethernet cable and simplify cable preparation
- Replaces traditional 3-layer industrial network structure with seamless connection via 100MB high-speed network
- Complete industrial network diagnosis for shortened debug time

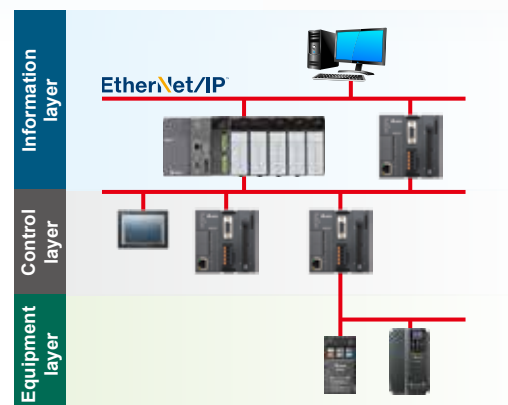

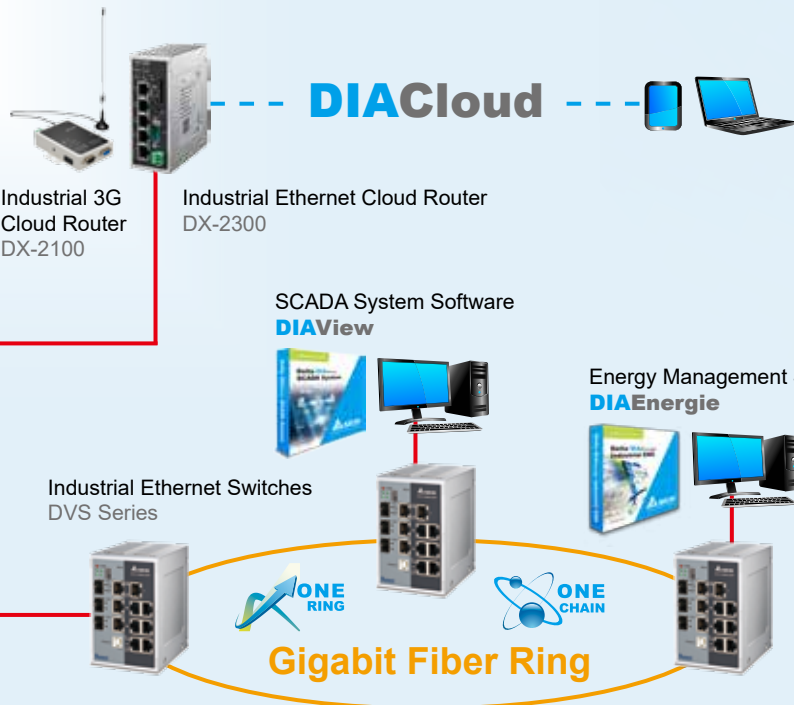

IoT & Industrial Ethernet

- DIACloud platform connection
- Redundancy ring recovery time < 20 ms
- Industrial class EMC testing

Software integration

- Consistent data exchange interfaces shortens learning time with fast system configuration
- Provides Delta equipment parameter list for quick parameter matching without looking into detailed manual
- EDS File provides quick connection with EtherNet/IP products of other brands

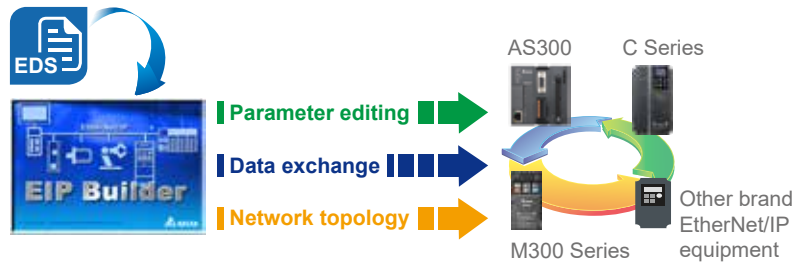

Accurate data update

- Provides real-time cyclic and acyclic data transmission and define data priority between equipment
- Establishes multiple CIP links and define different register priority with one piece of equipment
- Executes data update based on user RPI. Updates all slave station data in one scan time
- 70% better stability compared with traditional Modbus TCP

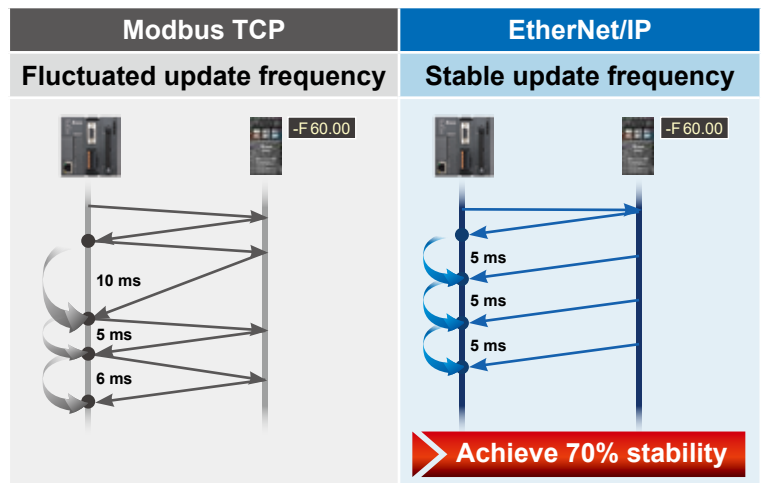

Remote I/O Solution

CANopen Remote I/O

- Max quantity of RIO stations: 15 stations
- Max quantity of IO modules (CPU right side + RIO (SCM) right side): 32 modules
 - Max DIO points: 1,024 points
 - Max quantity of AIO modules: 16 modules
 - Max quantity of communication modules: 4 modules (Only installed on CPU right side)
- Max quantity of IO modules installed on RIO (SCM) right side: 8 modules
- AS-FCOPM can only be installed in slot 2 of the CPU and SCM
 - When a CPU is installed as AS-FCOPM in slot 2, then slot 1 can be used to install another function card except AS-FCOPM
 - When SCM is working in RIO (RTU) mode, then slot 1 is disabled

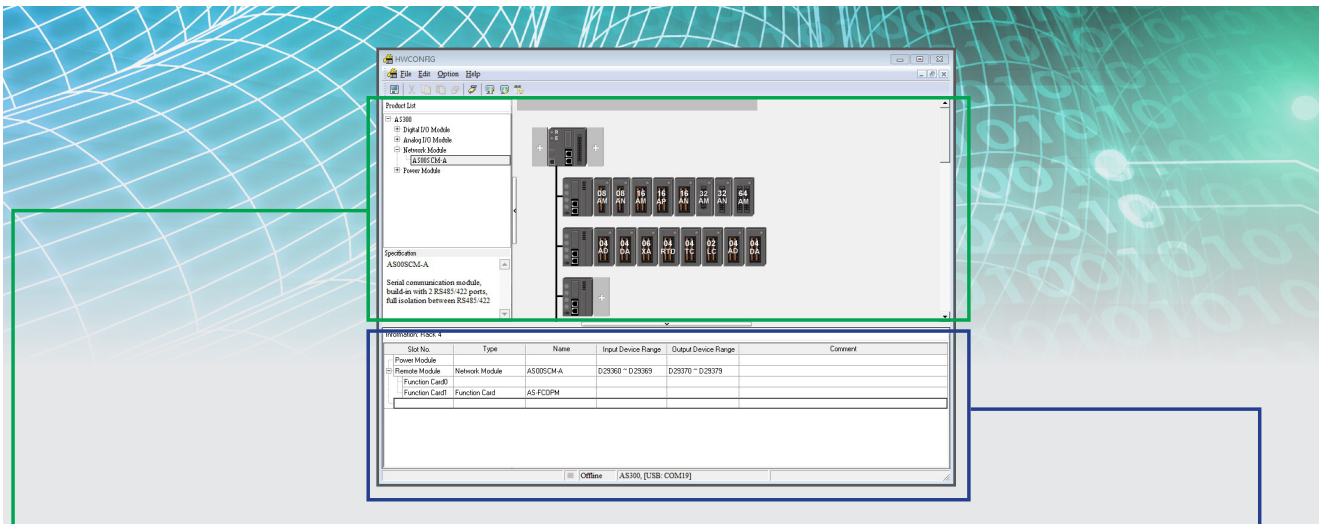
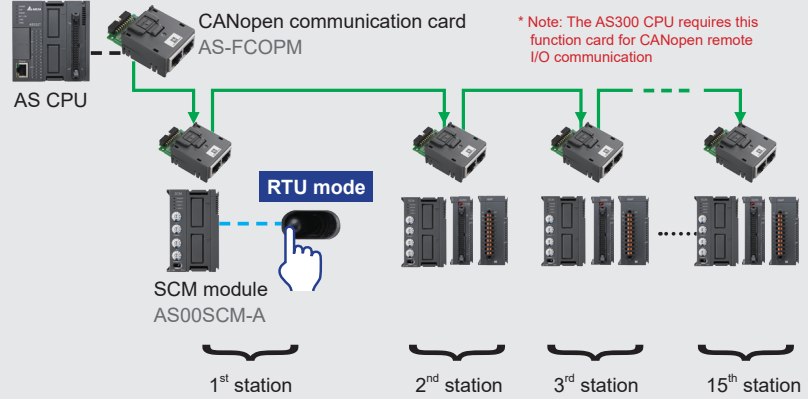

Hardware Configuration

- Hardware parameter complete planning

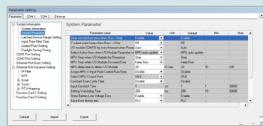

Visualized I/O Structure

- Direct I/O planning

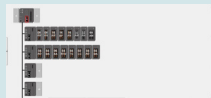

I/O Product List

- Product description and specification



I/O Without Planning

- Auto-mapping with I/O addresses in CPU (X, Y, and D)

DIO	Type	Name	Input Device Range	Output Device Range	Comment
Remote Module	Network Module	AS00SCM-A	D2900 ~ D2909	D29010 ~ D29019	
Function Card	Function Card	AS-FCOPM			
Module Information	Digital I/O Module	AS09M10N	X1.0 ~ X1.15		
Module Information	Digital I/O Module	AS09M01T		Y1.0 ~ Y1.15	
Module Information	Digital I/O Module	AS16M10N	X2.0 ~ X2.15		
Module Information	Digital I/O Module	AS16M01T		Y2.0 ~ Y2.15	
Module Information	Digital I/O Module	AS16M10N	X4.0 ~ X4.15		

AIO	Type	Name	Input Device Range	Output Device Range	Comment
Remote Module	Network Module	AS00SCM-A	D29100 ~ D29109	D291010 ~ D291019	
Function Card	Function Card	AS-FCOPM			
Module Information	Analog I/O Module	AS04M0.A	D25000 ~ D25019		D No.=00-010000-00-01-00-02-00-03-00-04
Module Information	Analog I/O Module	AS04M0.A		D29200 ~ D29209	D No.=00-010000-00-01-00-02-00-03-00-04
Module Information	Analog I/O Module	AS09M0.A	D29240 ~ D29249		D No.=00-010000-00-01-00-02-00-03-00-04
Module Information	Analog I/O Module	AS09M0.A		D29250 ~ D29259	D No.=00-010000-00-01-00-02-00-03-00-04
Module Information	Analog I/O Module	AS04TC.A	D29300 ~ D29309		D No.=00-010000-00-01-00-02-00-03-00-04
Module Information	Analog I/O Module	AS04TC.A		D29310 ~ D29319	D No.=00-010000-00-01-00-02-00-03-00-04

Serial Communication Solution

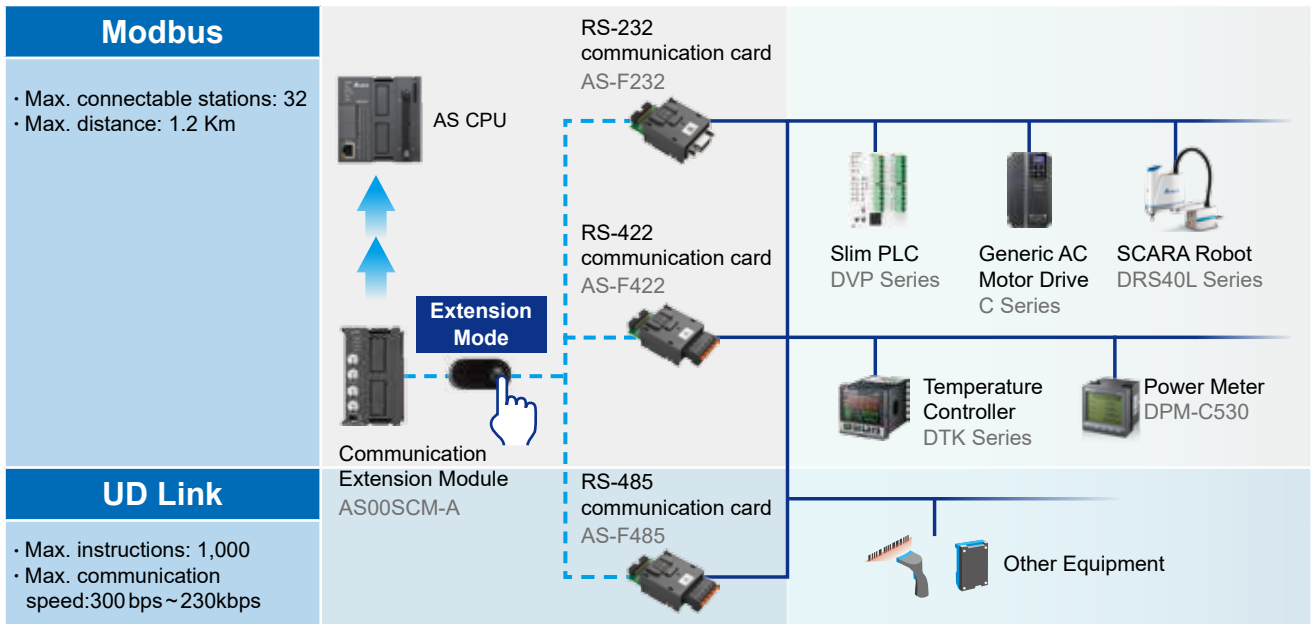

■ Modbus Mode

- Easy data exchange configuration



Real-time history log diagnosis

- AS00SCM stores 2k bytes history log. SCMSOft directly displays the log for real-time communication status monitoring with no additional monitoring software required

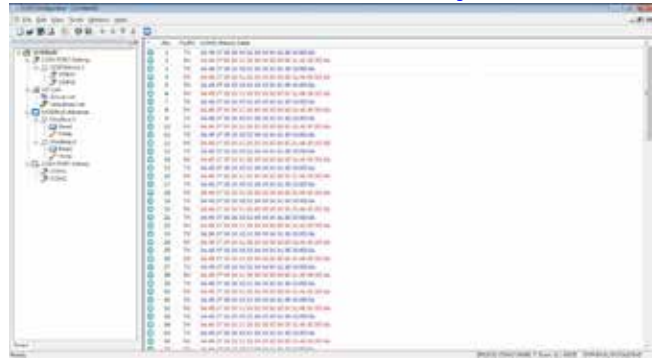

UD Link Mode (User-defined)

- Easy connection to end equipment of special communication protocols

Traditional programming structure

Instruction receiving, accessing, editing, transmitting, sequence control

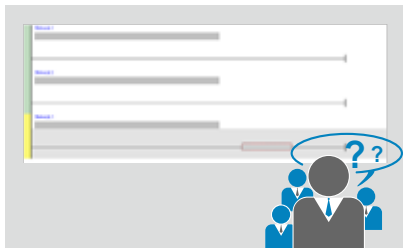

Connection to end equipment of special communication protocols

- Editing the transmitting/receiving packets via SCMSOft. Format exchange and checksum calculation via AS00SCM
- Packet content auto-combination for logic control in PLC, reducing PLC program complexity
- Max. 1,000 transmitting/receiving packets

Packet No.	RX Packet Name
1	RX Packet1
2	RX Packet2
3	RX Packet3

Packet No.	TX Packet Name
1	TX Packet1
2	TX Packet2
3	TX Packet3

No.	Class	Format	Segment View
1	Message Constant	ASCII	"abcd"
2	Address Variable	Null	(R/D Register [4], 4)
3	Message Constant	ASCII	"efgh"

Instruction execution sequence planning

Command No.	Command Type	Send Packet	Recv Packet	Success	Fail	Retry	Repeat	Send Wait
1	Send & Receive	TX Packet1	RX Packet1	Goto : 1	Goto : 1	0	2	0
2	Send & Receive	TX Packet2	RX Packet2	Goto : 2	Goto : 1	0	3	0
3	Send & Receive	TX Packet21	RX Packet3	Goto : 3	Goto : 1	0	4	0
4	Send & Receive	TX Packet25	RX Packet4	Goto : 4	Goto : 1	0	5	0
5	Send & Receive	TX Packet28	RX Packet5	Goto : 5	Goto : 1	0	6	0

User-defined communication format editing

Programming and Diagnosis Functions

ISPSoft IEC Programming Software

Easy operation greatly enhances efficiency

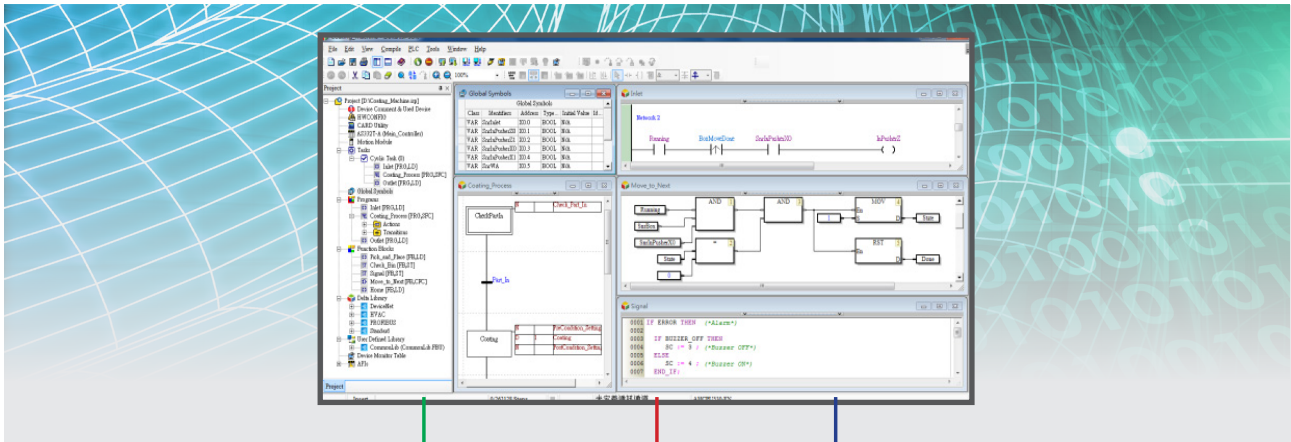

Data Tracer/Logger

- Data log and time-sequential analysis

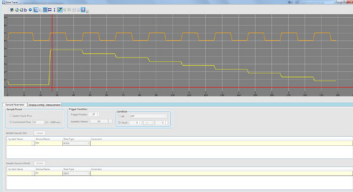

Positioning Planning Tool

- Table-structured position planning

No.	Axis	Position	Speed	Accel.	Decel.	Time	Completion	Status
1	Axis 1	Position	Speed	Accel.	Decel.	Time	Completion	No alarm
2	Axis 1	Position	Speed	Accel.	Decel.	Time	Completion	No alarm
3	Axis 1	Position	Speed	Accel.	Decel.	Time	Completion	No alarm

CARD Utility

- Data backup tool

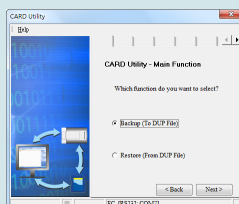

COMMGR

- Communication interface manager

Name	Description	Status
Device1	Ethernet, Bluetooth Device (Personal Area Network), Local	OK



HWCONFIG

- Hardware configuration and parameter setting

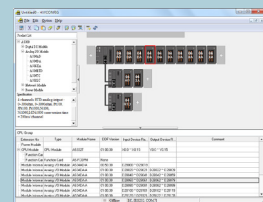

EIP Builder

- EtherNet/IP network configuration

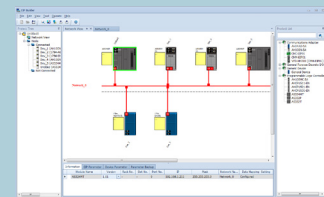

CANopen Builder

- CANopen network configuration

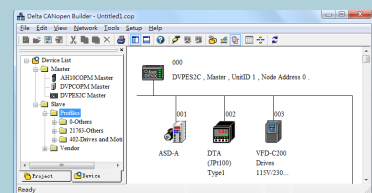

Modular Program Structure

Traditional program structure

Errors are often found in large-scale programs under a traditional structure. It's hard to debug with increased maintenance cost.

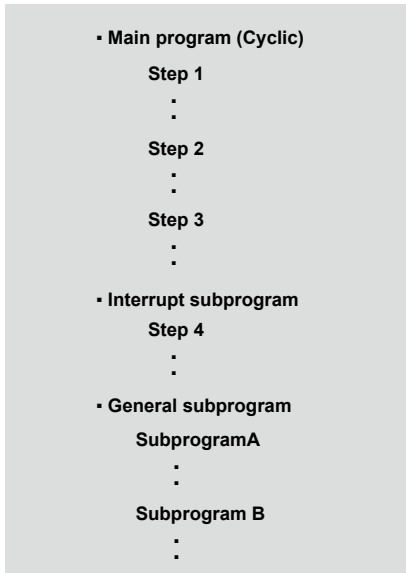

Modular program structure

Programming organization unit (POU) enables easy management in large-scale programs with high development efficiency.

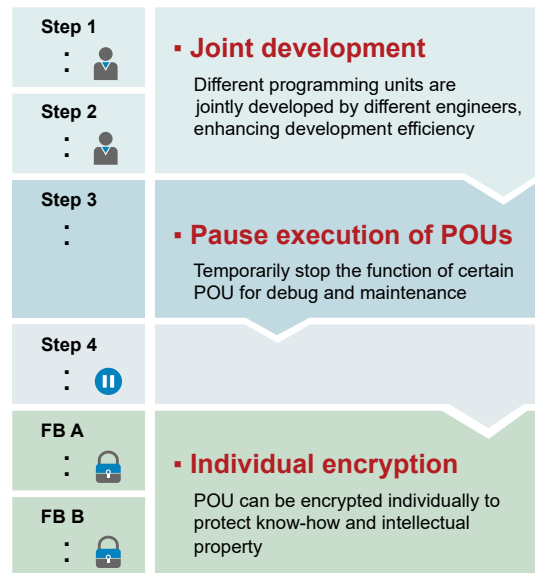

Modular Program Structure

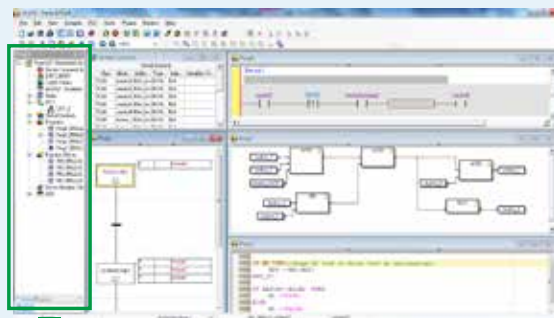

Display panel of task manager

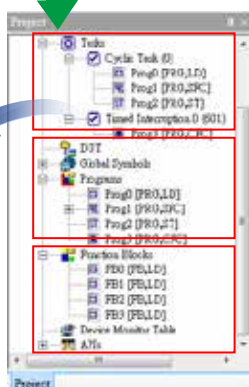

Task manager

Plan the execution sequence of POUs and define the nature of the tasks (cyclical or interruptive)

POU management

Manage all POUs via project tree and support POU import/export for joint development or other uses

User library

Built-in variety of Delta developed FBs. Users can add frequently used FBs to the library for future use.

Convenient Programming

- **User-defined data type**

In addition to basic data types, users can define structures and enumerations for flexible programming

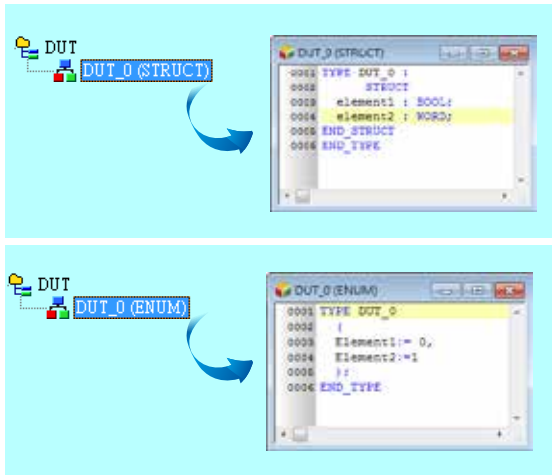

- **On-line programming / update**

Supports program editing in monitoring mode and program updates during equipment operation for convenient debugging and maintenance



- **Debugging mode**

Supports breakpoints, single step execution and other functions to enhance debugging efficiency

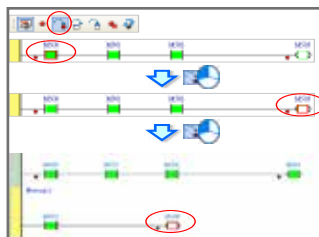

Various Programming Languages

- **Support multiple programming languages in the same project**

- **Ladder Diagram (LD)**

ISPSOft provides a programming interface with the widely used LD language for faster programming

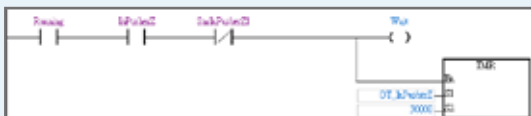

- **Structured Text (ST)**

Similar programming method to advanced programming language C or PASCAL. ST provides more convenient editing for complicated expression

```

0001 (* Calculate the total rate *)
0002 CASE IF : Rate and (Not Err) : THEN
0003   Rate := Rate + 1;
0004 END CASE
0005
0006 *Note: * Rate := 0;
0007 END ST
    
```

- **Continuous Function Chart (CFC)**

CFC provides more advanced applications than FBD. It supports data feedback, direct display of data stream and execution sequence for motion control and sequence-centered application



Note: ISPSOft V3.01 supports CFC language

- **Sequential Function Chart (SFC)**

Direct and easy expression for the steps in flow charts for applications that require process control

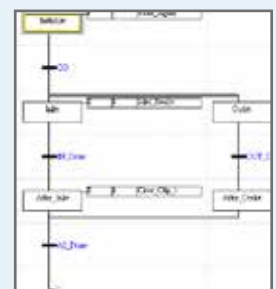

Easy Hardware Configuration and Parameter Setting

HWCONFIG

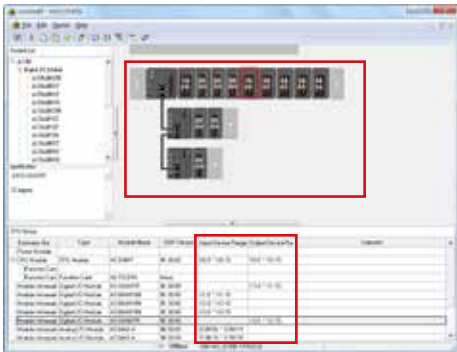

- **Graphic panel for module configuration**
Easy configuration based on connecting equipment scanning for quick setup

- **I/O listing**
Direct display for corresponding device addresses after configuration



- **Parameter setting**
Fast parameter setting on controller and modules without manual reference or programming

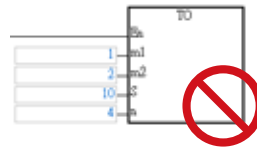

Note: Fill the table to configure module parameters quickly.
From/To instruction is not required for module initialization.

- **Module configuration method**

- **Smart module configuration**

Supports an advanced planning tool for a variety of network modules

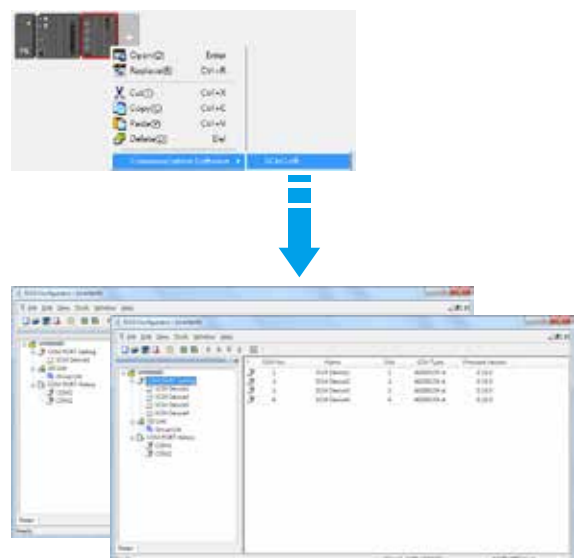
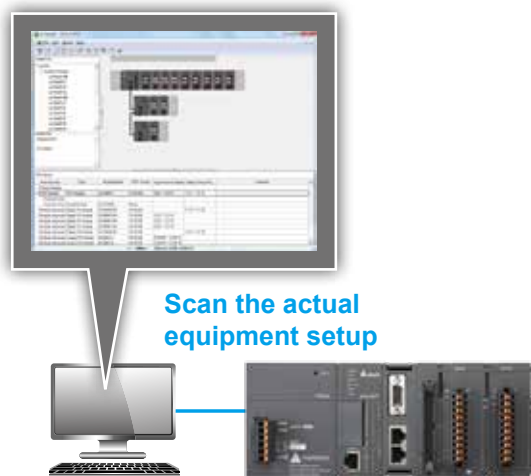

Complete Diagnosis Tools for Quick and Effective System Monitoring

Data Logger/Tracer

- Real-time
- Stable
- Precise

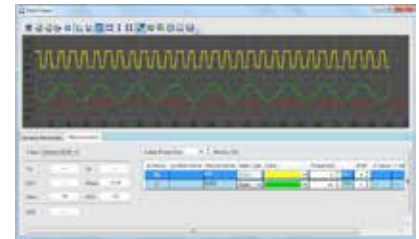

- **Real-time monitoring:**
High-speed tracer for fast sampling within 1 scanning cycle
- **Stable logging:**
Long-time data logger savings of up to 32,768 data records, which can be transferred to SD card
- **Precise data capture:**
Supports a variety of sampling intervals and trigger modes
- **Convenient comparison:**
Multiple data logs in various data formats can be recorded at the same time
- **Efficient data analysis:**
Supports trend display, scaling, arrangement, merge and measurement

Real-time Module Monitoring

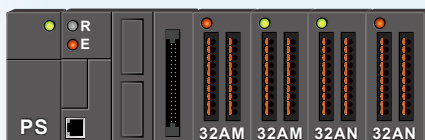

- **Visualized monitoring**
Direct monitoring interface provides real-time status on modules via LED indicators
- **Module comparison**
Real-time inspection of actual module settings to ensure consistency
- **Error logs**
Immediate inquiry for error messages and logs of abnormal modules
- **Module information**
Provides model name and version of current modules



Convenient Software Wizards for Effortless Planning

Position planning table

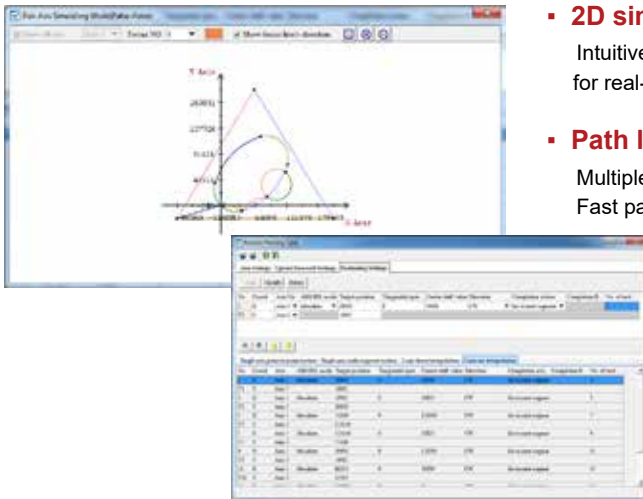

- **2D simulation**
Intuitive 2D track simulation without complicated calculation for real-time path planning
- **Path list**
Multiple combinations for positioning modes and tracks
Fast path planning via table-structured planning
- **Axis parameter setting**
Intuitive configuration interface for easy axis parameter setting without manual reference

High-speed counter setting tool

Counter index will display corresponding contact point, device and counter specification once the counting mode is chosen. Fast planning without manual reference for enhanced development efficiency.

One-time setting

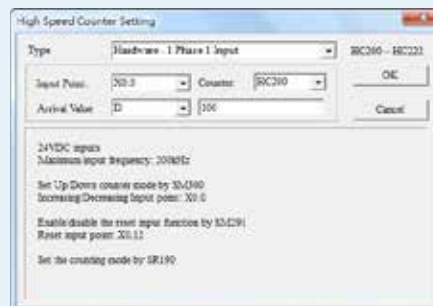

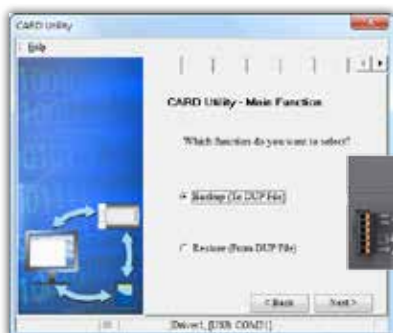

Data backup tool - CARD Utility

Friendly guidance interface for easy data backup and restore on programs, parameters and devices



Various backup and restore methods for flexible management and operation



-  Data backup to PC
-  Data backup to SD card

Multiple Security Protection for Programs and Data

- **Security: provides 6 types of program protection for data safety**

- 16-digit password protection on main program
- 16-digit password protection on FBs
- Access denial mechanism on error login
- Data upload protection function
- Verification between Project (Programming ID) and CPU (PLC ID)

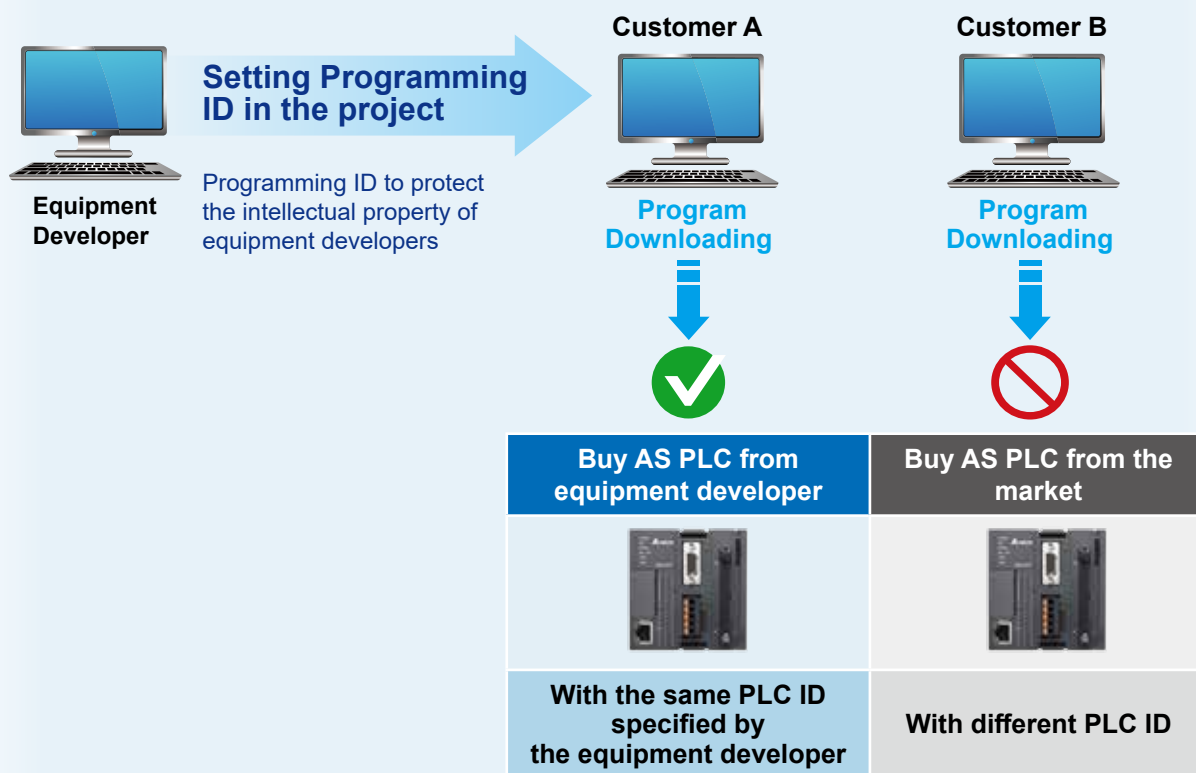

- Prevention of direct copy from IC



Model Name Explanation

CPU Module

AS332T-A

AS	3	32		T		-	A
Series	Model	IO Pts.		Output type			Type
	3: 300 2: 200	00: None 18: 18 Pts. 20: 20 Pts.	24: 24 Pts. 28: 28 Pts. 32: 32 Pts.	N: None T: NPN P: PNP	R: Relay MT: NPN+Diff.		[300 CPU] A: HDC terminal B: EU terminal [200 CPU] A: Basic

Digital I/O Module

AS08AM10N-A

AS	08	AM	1	0	N	-	A
Series	IO Pts.	Classification	Function		Output type		Type
	08: 8 Pts. 16: 16 Pts. 32: 32 Pts. 64: 64 Pts.	AM: Digital input AN: Digital output AP: Digital input/output	0: No input 1: DC input (24V)	0: No output 1: 0.5A transistor/2A relay output 2: 0.1A transistor output	N: No output T: NPN P: PNP R: Relay		A: Basic

Analog I/O Module

AS04AD-A

AS	04	AD	-	A
Series	IO Channels	Classification		Type
	04: 4-channel 06: 6-channel 08: 8-channel	AD: Analog input DA: Analog output XA: Analog input/output		A: Voltage/Current B: Voltage C: Current

Motion Module

AS02PU-A

AS	02	PU	-	A
Series	IO Channels	Classification		Type
	02: 2-channel 04: 4-channel	PU: Pulse-train output		A: Basic

Temperature & Load Cell Module

AS04RTD-A

AS	04	RTD	-	A
Series	IO Channels	Classification		Type
	02: 2-channel 04: 4-channel 06: 6-channel 08: 8-channel	RTD: Platinum resistance thermometer TC: Thermocouple LC: Load cell		A: Basic

Communication Module

AS00SCM-A

AS	00	SCM	-	A
Series	Function	Classification		Function
	00: Basement 01: Basic	SCM: Serial DENT: DeviceNet		A: Basic

Function Card

AS-F232

AS	-	F	232
Series		Classification	Function
		F: Function card	232: RS-232 422: RS-422 485: RS-485 COPM: CANopen 2AD: 2-channel analog input 2DA: 2-channel analog output EN02: Ethernet PFN02: PROFINET

Power Supply Module

AS-PS02

AS	-	PS	02
Series		Classification	Function
		PS: Power supply	02: AC Input (100~240V) 02A: AC Input (100~240V) + DC Output (24V, 0.5A)

Product Models and Specifications

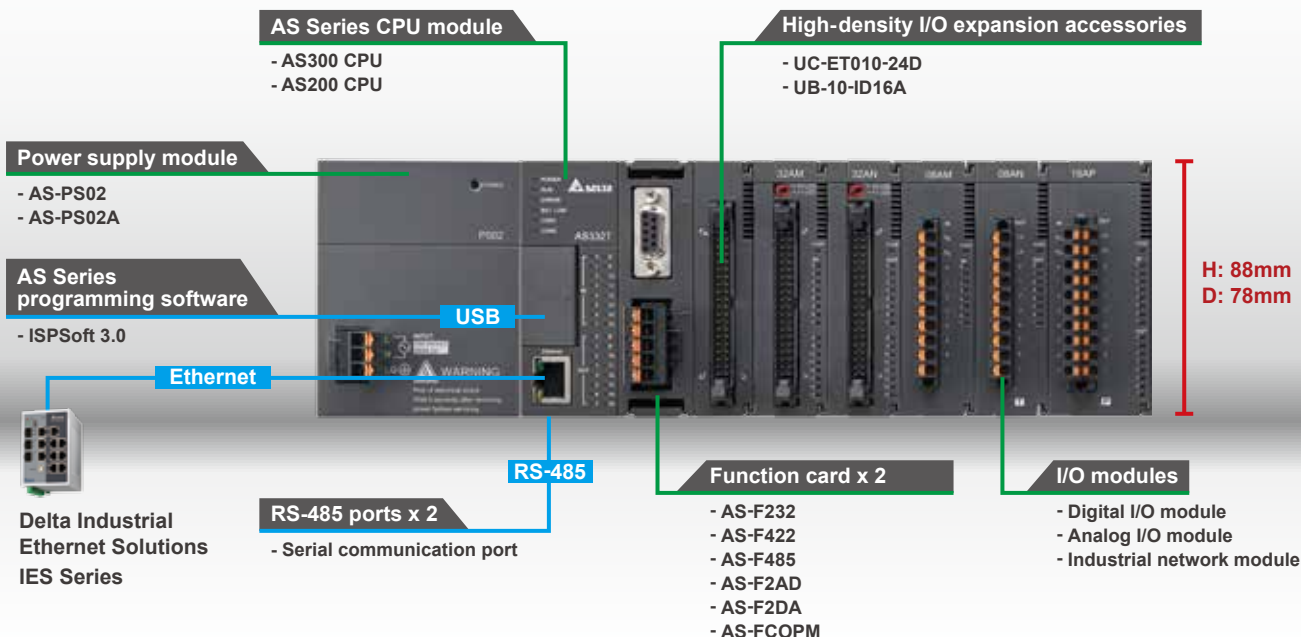

CPU Module

AS300 CPU



*1: Needs CANopen function card

AS300 Series CPU standard specification				
Program capacity 128k steps	Basic instruction 25ns	I/O capability: 1,024 Expansion modules: 32		
USB/RS-485 x 2/EtherNet	Micro SD Card	Function card x 2	EtherNet/IP Modbus CANopen remote I/O ^(*)	CANopen DS301 Position Control ^(*)
Model	Built-in I/O	High speed output	High speed input	
AS332T-A AS332P-A	16DI/16DO	6 axes 200 kHz pulse output	6 channels 200 kHz high-speed counters	
AS324MT-A (Differential)	12DI/12DO	2 axes + 4 axes 200 kHz pulse output	2 channels + 4 channels 200 kHz high-speed counters	
AS320T-B AS320P-B	8DI/12DO	6 axes 200 kHz pulse output	4 channels 200 kHz high-speed counters	
AS300N-A	-	-	-	

AS200 CPU



AS200 Series CPU standard specification				
Program capacity 64k steps	Basic instruction 25ns	I/O capability: 1,024 Expansion modules: 32		
USB/RS-485 x 2/EtherNet/CANopen	Micro SD Card	EtherNet/IP, Modbus CANopen remote I/O	CANopen DS301 Position Control	
Model	Built-in I/O	High speed output	High speed input	
AS228T-A AS228P-A AS228R-A	16DI/12DO	6 axes 200 kHz pulse output	4 channels 200 kHz high-speed counters	
AS218TX-A AS218PX-A AS218RX-A	8DI/6DO 2AI/2AO	3 axes 200 kHz pulse output	4 channels 200 kHz high-speed counters	

Power Supply AS-PS02		Power Supply AS-PS02A	
	Input 100V _{AC} ~ 240V _{AC} 24V _{DC} , 2A (for internal bus)		Input 100V _{AC} ~ 240V _{AC} 24V _{DC} , 1.5A (for internal bus) 24V _{DC} , 0.5A (for external I/O)

Product Specifications

Model		AS332T-A AS332P-A	AS324MT-A	AS320T-B AS320P-B	AS300N-A	AS228T-A AS228P-A AS228R-A	AS218TX-A AS218PX-A AS218RX-A
Programming Languages		Ladder Diagram (LD), Structured Text (ST), Continuous Function Chart (CFC), Sequential Function Chart (SFC)					
Instruction Processing Speed	LD Instruction	25 ns					
	MOV Instruction	0.15 μs					
	Elementary Arithmetic for Integer	0.92 μs ~ 1.02 μs					
	Elementary Arithmetic for Floating Point	1.69 ~ 1.85 μs					
Program Capacity		128k steps			64k steps		
Memory Capacity	Data (D)	64k words (including 30k user-defined, 30k software configuration and 4k special registers)					
	Extension (FR)	64k words (user parameter storage)					
Function Card		The CPUs support up to 2 function cards				-	
Max. Extension Modules		32 modules (max. 16 analog modules/4 communication modules)					
Max. Number of Inputs/Outputs		1,024 points (input & output)					
CPU Built-in Inputs/Outputs		16DI/16DO	12DI/12DO	8DI/12DO	-	16DI/12DO	8DI/6DO, 2AI/2AO
CPU Built-in Differential Inputs/Outputs		-	4 Inputs + 4 Outputs	-			
Inputs/Outputs	X	1,024 inputs (X0.0 ~ X63.15)					
	Y	1,024 outputs (Y0.0 ~ Y63.15)					
Bit Devices	M	8,192 bits (M0 ~ M8191)					
	S	2,048 bits (S0 ~ S2047)					
Timer	T	512 (T0 ~ T511)					
16-bit Counter	C	512 (C0 ~ C511)					
32-bit Counter	HC	256 (HC0 ~ HC255)					
Pulse Output		Open collector: 6 axes, 200 kHz	Open collector: 4 axes, 200 kHz Differential: 2 axes, 4 MHz	Open collector: 6 axes, 200 kHz	-	Open collector: 6 axes, 200 kHz	Open collector: 3 axes, 200 kHz
High-Speed Counter		General: 6 CHs, 200 kHz	General: 4 CHs, 200 kHz Differential: 2 CHs, 4 MHz	General: 4 CHs, 200 kHz	-	General: 4 CHs, 200 kHz	General: 4 CHs, 200 kHz
DO Type		AS332T-A: NPN AS332P-A: PNP	Diff./NPN	AS320T-B: NPN AS320P-B: PNP	-	AS228T-A: NPN AS228P-A: PNP AS228R-A: Relay	AS218TX-A: NPN AS218PX-A: PNP AS218RX-A: Relay
Built-in Communication Port		USB, Ethernet, RS-485 x2				USB, Ethernet, RS-485 x2, CANopen	
Communication Protocol		Modbus, Modbus TCP, EtherNet/IP, CANopen (requires a CANopen function card)				Modbus, Modbus TCP, EtherNet/IP, CANopen	
Ethernet Connection Resource		Modbus (Client/Server): 32/32 EtherNet/IP (CIP): 32				Modbus (Client/Server): 16/16 EtherNet/IP (CIP): 16	

Product Specifications

Model		AS332T-A AS332P-A	AS324MT-A	AS320T-B AS320P-B	AS300N-A	AS228T-A AS228P-A AS228R-A	AS218TX-A AS218PX-A AS218RX-A
Data Backup (Without Battery)	Program	Flash ROM, rewritable up to 100,000 times					
	Latched Area	MRAM, no rewriting limit					
CANopen DS301	Connectable Salve Stations	Max. 64 points					
	PDO Data Capacity (Host)	Max. 2,000 bytes (Read & Write)					
	PDO Data Capacity (Slave)	Max. 8 PDO (Read & Write); Max. 8 bytes for each PDO					
Real-time Clock (RTC)		General Lithium button battery (CR1620)					
Self-Diagnosis Function		diagnoses CPU errors, built-in memory errors, and more					
Rated Input Current	AS-PS02/AS-PS02A	110 V _{AC} ~ 240 V _{AC} (±10%)					
	CPU	24 V _{DC} (±10%)					
	Extension modules						

Electrical and Environmental Specifications

Item	Specifications	
Internal Power Consumption	CPU	150 mA
	Extension Module	Digital relay output <150 mA, Other modules < 80 mA
Operating Temperature	-20 ~ 60 °C	
Storage Temperature	-40 ~ 80 °C	
Operating Humidity	5 ~ 95%, non-condensing	
Storage Humidity	5 ~ 95%, non-condensing	
Vibration	IEC 61131-2, IEC 60068-2-6 (TEST Fc); 5 Hz ≤ f ≤ 8.4 Hz, constant amplitude 3.5 mm; 8.4 Hz ≤ f ≤ 150 Hz, constant acceleration 1g	
Shock	IEC 61131-2, IEC 60068-2-27 (TEST Ea); 15g peak, 11 ms duration, half-sine	
Operating Environment	Non-corrosive gas	
Installation	Inside of the control panel	
Pollution Degree	2	
Protection Rating	IP20	

Ethernet Specifications

Item		AS300 Series	AS200 Series	Note	
Protocol		Modbus TCP, EtherNet/IP, SMTP, HTTP		Supports all protocols at the same time	
Modbus TCP	Connection (Server)	32	16		
	Connection (Client)	32	16		
	RTU-EN01 Connection	4	4		
Socket	TCP Connection	4	2		
	UDP Connection	4	2		
SMTP	E-mail Connection	4	2		
Operation Mode		Scanner/Adapter			
EtherNet/IP	CIP_IO Connection	CIP Connection	32 (Client+Server)	16 (Client+Server)	Shared with IO Connection
		TCP Connection	16 (Client+Server)	8 (Client+Server)	Shared with IO Connection
		Requested Packet Interval (RPI)	5 ms ~ 1,000 ms		Default: 20 ms
		Max. Performance	3,000 pps		
		Max. Capacity per Connection	500 bytes		
	CIP_Explicit Message	Class 3 (Connected Type)	32 (Servers), shared with UCMM	16 (Servers), shared with UCMM	Shared with IO Connection
		UCMM (Non-Connected Type)	32 (Clients + Servers), shared with Class 3	16 (Clients + Servers), shared with Class 3	Shared with IO Connection
		Supported CIP Objects	Identity, Message Router, Assembly, Connection Manager, Port, TCP/IP interface, Ethernet link, Vendor specific		
	CIP_Produced TAG	Max. CIP Connections	32 (Servers)	16 (Servers)	Shared with IO Connection
		Max. Capacity	400 bytes		
Requested Packet Interval (RPI)		5 ms ~ 1000ms			
CIP_Consumed TAG	Max. CIP Connections	32 (Clients + Servers)	16 (Clients + Servers)	Shared with IO Connection	
	Max. capacity	400 bytes			
	Requested Packet Interval (RPI)	5 ms ~ 1000ms			
AS00SCM (RTU) + AS-FEN02 Connection Nodes		15	8	AS RTU Mode	

Please visit Delta's official website for selection

AS Series I/O Modules

Digital I/O Modules (Input)



Rated input voltage
5~24 V_{DC}

Response time
1 ms

Filter function
1~20 ms

Screwless removable
terminal block
8 / 16 inputs

8 inputs

Faster wiring
terminal block

AS08AM10N-A

16 inputs

Faster wiring
terminal block

AS16AM10N-A

32 inputs

High-density
MIL terminal block

AS32AM10N-A

64 inputs

High-density
MIL terminal block

AS64AM10N-A

Digital I/O Modules (Output)



NPN (Sink)
or PNP (Source)
module

Response time
1 ms (Transistor)
10 ms (Relay)

Screwless removable
terminal block
8 / 16 outputs

8 outputs

Faster wiring
terminal block
Transistor output
NPN (Sink)

AS08AN01T-A

8 outputs

Faster wiring
terminal block
Relay output

AS08AN01R-A

8 outputs

Faster wiring
terminal block
Transistor output
PNP (Source)

AS08AN01P-A

32 outputs

High-density
MIL terminal block
Transistor output
NPN (Sink)

AS32AN02T-A



16 outputs

Faster wiring
terminal block
Transistor output
NPN (Sink)

AS16AN01T-A

16 outputs

Faster wiring
terminal block
Relay output

AS16AN01R-A

16 outputs

Faster wiring
terminal block
Transistor output
PNP (Source)

AS16AN01P-A

64 outputs

High-density
MIL terminal block
Transistor output
NPN (Sink)

AS64AN02T-A

■ Digital I/O Modules (Mixed)



NPN (Sink) or PNP (Source) module	
Rated input voltage 5~24 V _{DC}	Filter function 1~20 ms
Screwless removable terminal block	
Response time 1 ms (Transistor) 10 ms (Relay)	

16 inputs / outputs	16 inputs / outputs	16 inputs / outputs
Faster wiring terminal block 8 inputs/8 transistor outputs NPN (Sink)	Faster wiring terminal block 8 inputs 8 relay outputs	Faster wiring terminal block 8 inputs/8 transistor outputs PNP (Source)
AS16AP11T-A	AS16AP11R-A	AS16AP11P-A

■ Analog I/O Modules



4 channels	8 channels	8 channels	4 channels	6 channels
Analog input	Analog input	Analog input	Analog output	Analog input/output
AS04AD-A	AS08AD-B New	AS08AD-C New	AS04DA-A	AS06XA-A
Conversion time 2 ms/channel	50/60Hz filter		A: Voltage and current B: Voltage C: Current	Resolution AI: 16-bit AO: 12-bit
Accuracy ±0.2%	4/6/8 CH		Module monitoring/configuration	Differential inputs

■ Load Cell Module



Functions		
50/60 Hz filter	High-speed dynamic measurement	2 channels of independent sampling
Accuracy 0.4% full range	2 CH	Connectable to 4-wire/6-wire load cell sensor
full range		
Filter function	Multiple-point calibration	Online monitoring / configuration

2 channels
AS02LC-A

■ Pulse Unit Modules





Input: 200 kHz
Output: 200 kHz
Open Collector/Diff.
2/4 CH
Support Motion APIs

2 channels	4 channels
Differential	Open Collector
AS02PU-A New	AS04PU-A New

AS Series I/O Modules

■ Temperature Measurement Modules

		Conversion time 200 ms/channel		Resolution 0.1°C/0.1°F		Wire breaking detection	
4 channels PT, NI temperature sensor AS04RTD-A		6 channels PT, NI temperature sensor AS06RTD-A New		Overall accuracy ±0.1%	50/60 Hz filter	Module monitoring/configuration	
						4/6 CH	
Pt100/Ni100/Pt1000/Ni1000/JPt100/LG-Ni1000/Cu50/Cu100, resistor 0~300Ω, 0~3,000Ω							



		Conversion time 200 ms/channel		Resolution 0.1°C/0.1°F		Disconnection detection	
4 channels TC temperature sensor AS04TC-A		8 channels TC temperature sensor AS08TC-A New		Overall accuracy ±0.5%	50/60 Hz filter	Module monitoring/configuration	
						4/8 CH	
J, K, R, S, T, E, N, B type thermocouple; ±100 mV							





■ Communication Modules

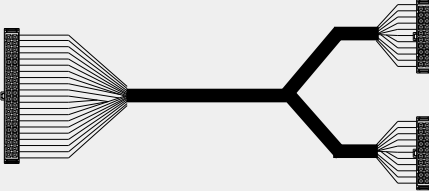

		COM port	RS-232C	RS-422	RS-485	CANopen
2 COM ports AS00SCM-A		Function	Selectable COM ports; supporting standard Modbus protocol and user-defined protocol			Delta communication protocol
		Software	SCMSOft	Data exchange table for quick setup		Real-time monitoring on communication status

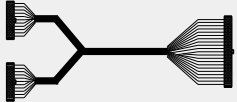
		COM port	DeviceNet			
DeviceNet AS01DNET-A New		Function	DeviceNet protocol (master/slave) and support RTU mode			
		Software	DeviceNet Builder			



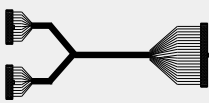

Accessory Selection for High-density Modules

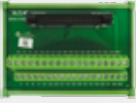

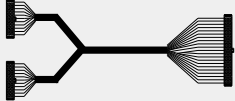
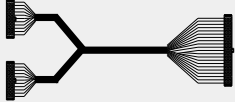

Model Name		
AS332T-A AS332P-A AS324MT-A	UC-ET010-24D (1M) UC-ET020-24D (2M) UC-ET030-24D (3M)	UB-10-ID16A
		
		UB-10-ID16A (NPN/PNP) UB-10-OR16A (NPN to Relay) UB-10-OR16B (PNP to Relay)
		

Model Name				
UB-10-ID16A	UC-ET010-24D (1M) UC-ET020-24D (2M) UC-ET030-24D (3M)	AS32AM10N-A	UC-ET010-24B (1M) UC-ET020-24B (2M) UC-ET030-24B (3M)	UB-10-ID32A
				

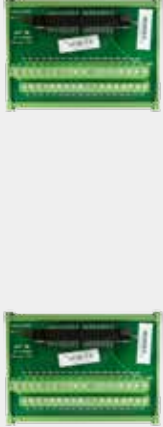
Model Name					
UB-10-ID16A or UB-10-OR16A (Relay)	UC-ET010-24D (1M) UC-ET020-24D (2M) UC-ET030-24D (3M)	AS32AN02T-A	UC-ET010-24B (1M) UC-ET020-24B (2M) UC-ET030-24B (3M)	UB-10-OT32A	
					

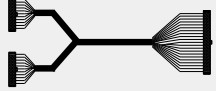
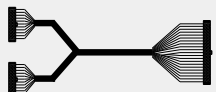
Accessory Selection for High-density Modules

Model Name				
UB-10-ID16A	UC-ET010-24D (1M) UC-ET020-24D (2M) UC-ET030-24D (3M)	AS64AM10N-A	UC-ET010-24B (1M) UC-ET020-24B (2M) UC-ET030-24B (3M)	UB-10-ID32A
	 		 	

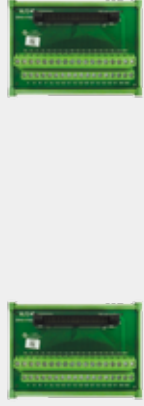
Model Name				
UB-10-ID16A or UB-10-OR16A (Relay)	UC-ET010-24D (1M) UC-ET020-24D (2M) UC-ET030-24D (3M)	AS64AN02T-A	UC-ET010-24B (1M) UC-ET020-24B (2M) UC-ET030-24B (3M)	UB-10-OT32A
	 		 	

Dimensions

CPU Modules

Dimensions are in mm

AS332T-A, AS332P-A, AS324MT-A

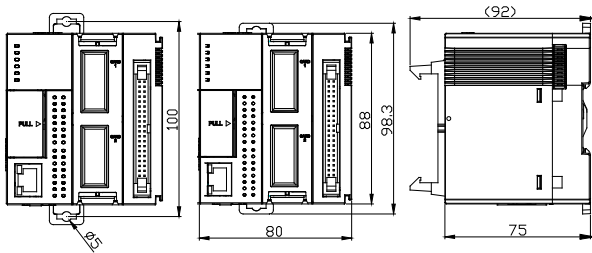

AS300N-A **New**

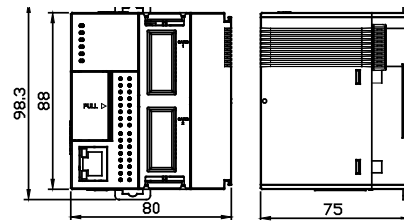

AS320T-B **New**, AS320P-B **New**

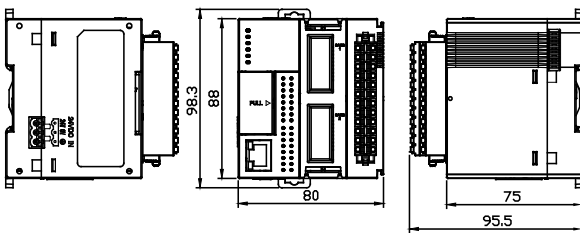

AS228T-A **New**, AS228P-A **New**, AS228R-A **New**
AS218TX-A **New**, AS218PX-A **New**, AS218RX-A **New**

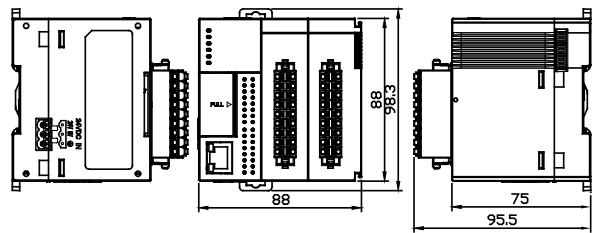

Digital I/O Modules

Dimensions are in mm

AS08AM10N-A, AS08AN01R-A,
AS08AN01T-A, AS08AN01P-A

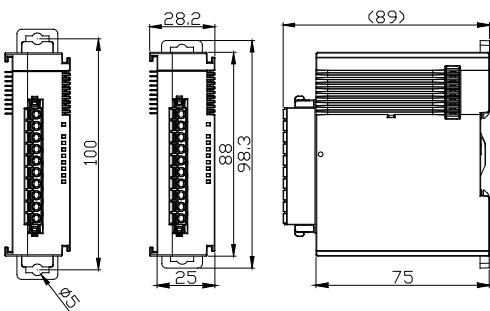

AS16AM10N-A, AS16AN01R-A, AS16AN01T-A,
AS16AN01P-A, AS16AP11R-A, AS16AP11T-A,
AS16AP11P-A

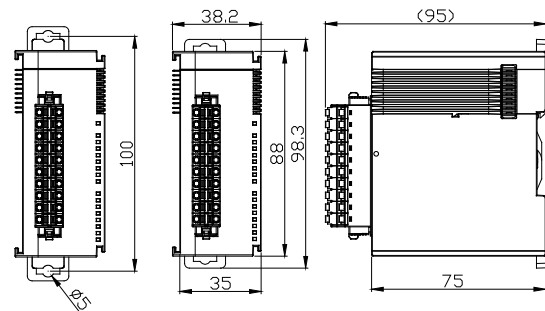

AS32AM10N-A, AS32AN02T-A

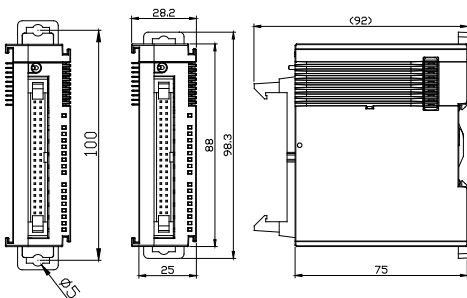

AS64AM10N-A, AS64AN02T-A

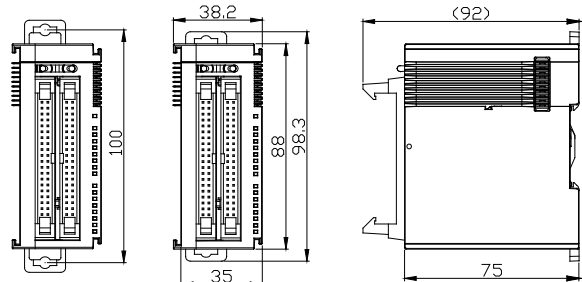

Dimensions

Power Supply Modules

Dimensions are in mm

AS-PS02, AS-PS02A

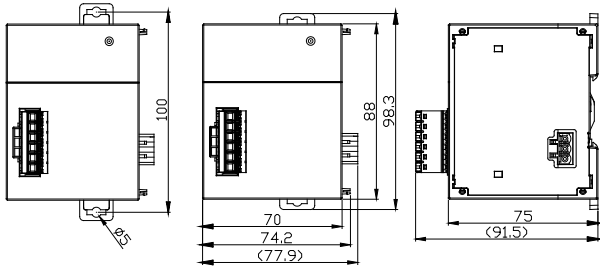

Pulse Unit Module

Dimensions are in mm

AS02PU-A **New**, AS04PU-A **New**

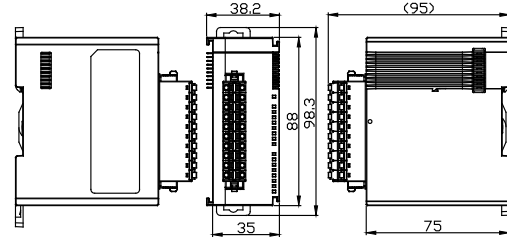

Communication Modules

Dimensions are in mm

AS00SCM-A

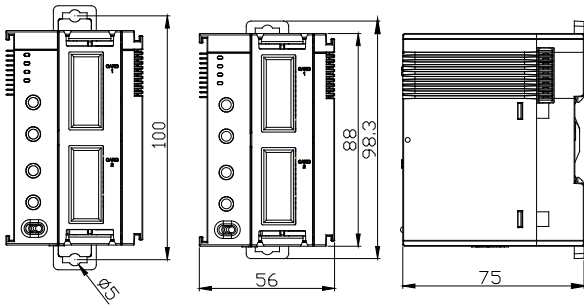

AS01DNET-A **New**

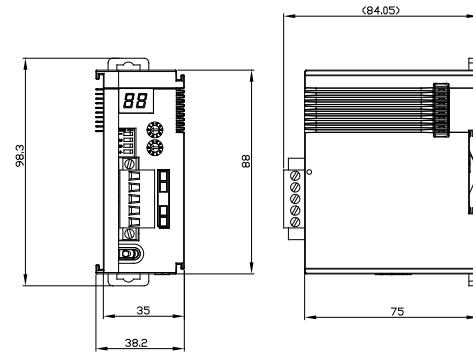

Analog Modules

Dimensions are in mm

AS02LC-A, AS04AD-A, AS04DA-A, S04TC-A,
AS04RTD-A, AS06XA-A, AS08AD-B **New**, AS08AD-C **New**,
AS06RTD-A **New**, AS08TC-A **New**

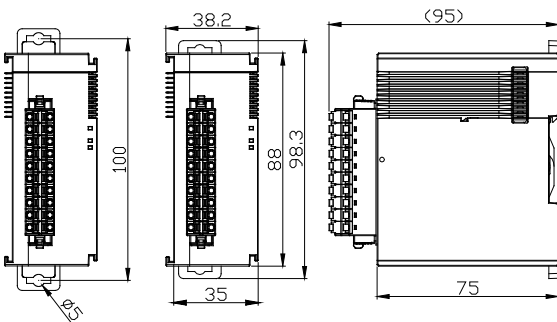

Connector Converter

Dimensions are in mm

UB-10-IO32D **New**

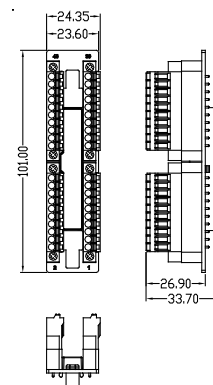

Function Cards

Dimensions are in mm

AS-F232

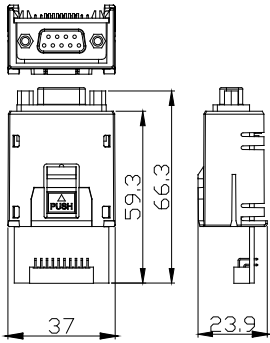

AS-FCOPM

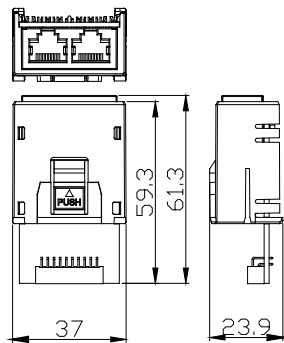

AS-F2AD, AS-F2DA,
AS-F422, AS-F485

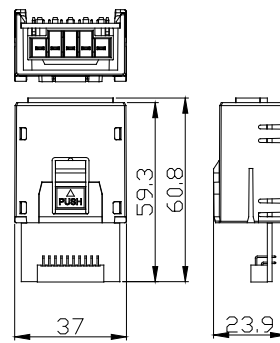

AS-FEN02 **New**
AS-PPFN02 **New**

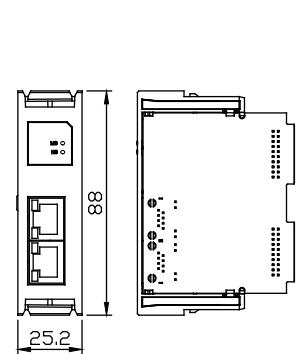

Installation Notes

Dimensions are in mm

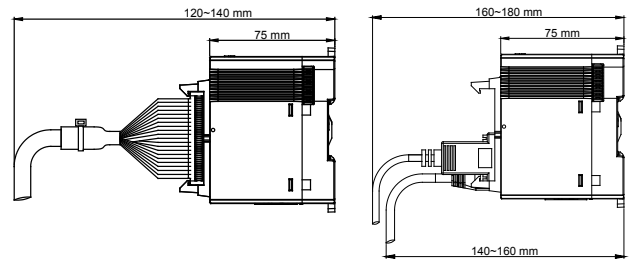
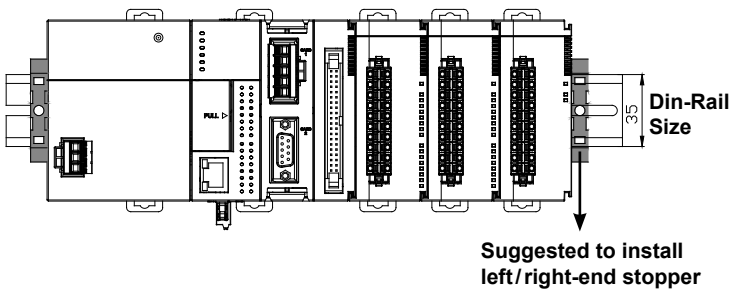

Cable (MIL)

Dimensions are in mm

UC-ET010-24D (1 M), UC-ET020-24D (2 M),
UC-ET030-24D (3 M)

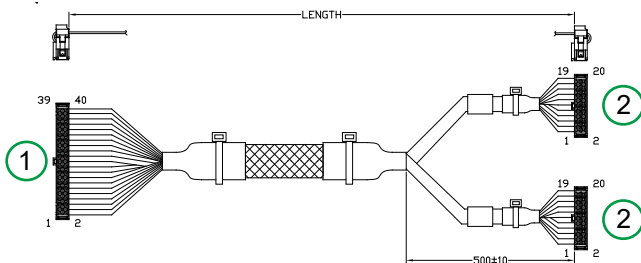

UC-ET010-24B (1 M), UC-ET020-24B (2 M),
UC-ET030-24B (3 M)

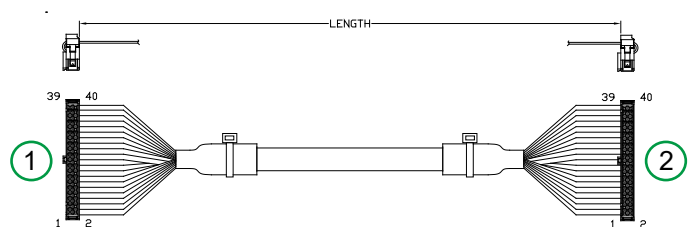

Serial	Name	Description
①	40-pin terminal	Connect to modules
②	20-pin terminal	Connect to external terminal modules UB-10-ID16A or UB-10-OR16A or UB-10-OR16B

Serial	Name	Description
①	40-pin terminal	Connect to modules
②	40-pin terminal	Connect to external terminal modules UB-10-ID32A or UB-10-OT32A

Dimensions

External Terminal Modules

Dimensions are in mm

UB-10-OR16A, UB-10-OR16B

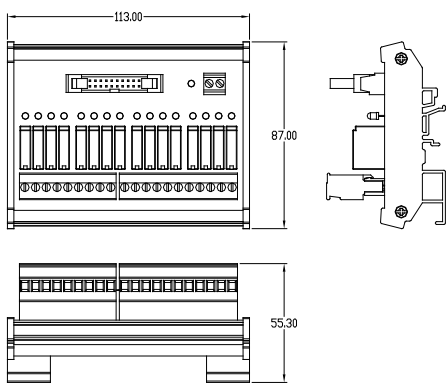

UB-10-OT32A

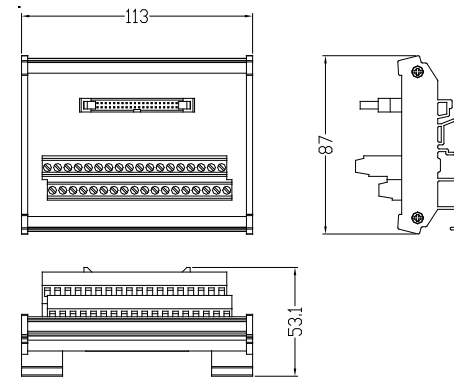

UB-10-ID16A

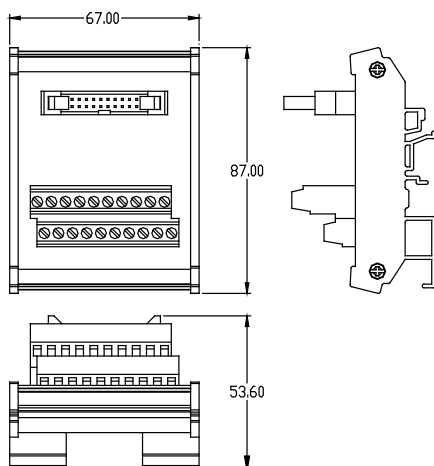

UB-10-ID32A

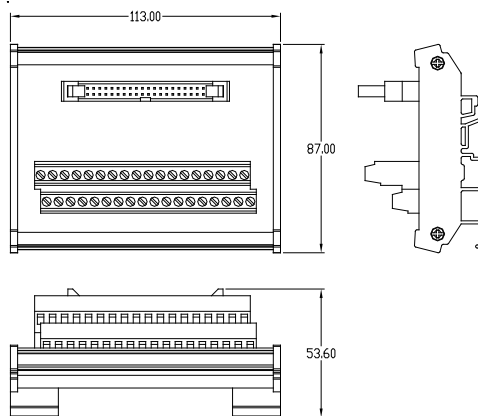

Auxiliary Connected Power Module

Dimensions are in mm

AS-ATXB

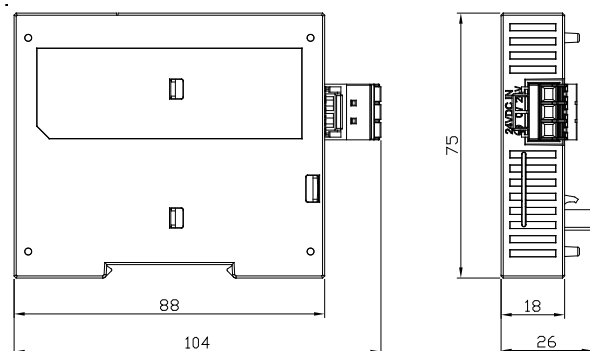

Ordering Information

■ CPU Module

Name	Model	Instruction Speed/Performance	Memory / CPU Clock	Max. Inputs & Outputs/Extension Module (Max. Extension Racks)	Memory Card	Certification
CPU	All models	LD: 25 ns MOV: 0.15 μs	RAM: 2 MB ROM: 4 MB CPU clock: 400 MHz	1,024 inputs & outputs/32 modules (Max. 15 extension racks)	Micro SD Max. 32GB	CE/UL
		40k steps/1ms (LD 40%, MOV 60%)				

Name	Model	Program Capacity	Built-in I/O	DO Type	Terminal Block	High-Speed Counter	Pulse-train Output	Built-in Communication	Function Card Slot
CPU	AS332T-A	128k steps	16DI/16DO	NPN	MIL	6 CHs, 200 kHz	6 Axes, 200 kHz (12 CHs, 200 kHz)	USB RS-485*2 Ethernet	2
	AS332P-A			PNP					
	AS324MT-A		12DI/12DO	Diff./NPN		2 CHs, 4 MHz (Diff.) 4 CHs, 200 kHz	2 Axes, 4 MHz (Diff.) 4 Axes, 200 kHz		
	AS320T-B New		8DI/12DO	NPN	EU	4 CHs, 200 kHz	6 Axes, 200 kHz (12 CHs, 200 kHz)		
	AS320P-B New			PNP					
	AS300N-A New		-	-	-	-	-		
	AS228T-A New	64k steps	16DI/12DO	NPN	EU	4 CHs, 200 kHz	6 Axes, 200 kHz (12 CHs, 200 kHz)	USB RS-485*2 Ethernet CANopen	-
	AS228P-A New			PNP					
	AS228R-A New			Relay					
	AS218TX-A New		8DI/6DO 2AI/2AO ⁽¹⁾	NPN		4 CHs, 200 kHz	3 Axes, 200 kHz (6 CHs, 200 kHz)		
	AS218PX-A New			PNP					
	AS218RX-A New			Relay					

Note: The specifications of the built-in AIO are the same as AS-F2AD/AS-F2DA function cards.

■ Software

Product Name	License	Descriptions	Supported Device
ISPSoft [V3]	Free	PLC programming software	AS Series, AH Series, DVP Series
COMMGR [V1]	Free	Communication management software	AS Series, AH Series, DVP Series
DCISoft [V1]	Free	Ethernet configuration software	AH series Ethernet/serial communication modules, AS series SCM module, DVP series built-in Ethernet PLCs, DVP series Ethernet/serial communication modules, IFD series Ethernet modules
	Free	SCM serial communication module planning software	AS Series, AH Series, DVP Series SCM communication modules
CANopen Builder [V5]	Free	CANopen configuration software/motion control programming software	AS Series, AH Series, DVP Series built-in CANopen communication modules
EIP Builder [V1]	Free	EtherNet/IP configuration software	AS Series, AH Series, DVP Series built-in Ethernet communication modules
Delta OPC [V2] (HASP-20-OPC01)	Hardware License (USB)	Delta OPC Server	AS Series, AH Series,

■ Power Supply Module

Name	Model	Input	Output	Certification
Power Supply Module	AS-PS02	100~240 V _{AC}	24 V _{DC} , 2A (for modules on the rack)	CE/UL
	AS-PS02A		24 V _{DC} , 1.5A (for modules on the rack) 24 V _{DC} , 0.5A (for external I/O)	

Ordering Information

■ Communication Module

Name	Model	Communication Card Installation	Power Consumption (Internal)	Specifications	Certification
Communication Extension Module	AS00SCM-A	2	0.6W	<ul style="list-style-type: none"> Serial communication: RS-232/RS-422/RS-485 Provide CANopen communication interface for extension racks 	CE/UL
DeviceNet Communication Module	AS01DNET-A <small>New</small>	-	0.8W	<ul style="list-style-type: none"> DeviceNet protocol Supports master/slave modes Supports RTU function 	

■ Digital I/O Module

Name	Model	I/O	Signals	Terminal Block Type	Power Consumption (Internal)	Certification
Input Module	AS08AM10N-A	8	24 V _{DC} 5 mA	Removable terminal block	0.72 W	CE/UL
	AS16AM10N-A	16			0.72 W	
	AS32AM10N-A	32		MIL	0.48 W	
	AS64AM10N-A	64			0.72 W	

Name	Model	I/O	Signals	Terminal Block Type	Power Consumption (Internal)	Specifications	Certification
Output Module	AS08AN01R-A	8	240 V _{AC} 24 V _{DC}	Removable terminal block	1.7 W	Relay	CE/UL
	AS16AN01R-A	16			3.4 W	Relay	
	AS08AN01T-A	8	5~30 V _{DC} 0.5A		0.72 W	Transistor NPN (Sink)	
	AS08AN01P-A	8			1.4 W	Transistor PNP (Source)	
	AS16AN01T-A	16			1.4 W	Transistor NPN (Sink)	
	AS16AN01P-A	16			1.4 W	Transistor PNP (Source)	
	AS32AN02T-A	32	5~30 V _{DC} 0.1A	MIL	0.72 W	Transistor NPN (Sink)	
	AS64AN02T-A	64			1.44 W	Transistor NPN (Sink)	

Name	Model	I/O	Signals		Terminal Block Type	Power Consumption (Internal)	Specifications	Certification
			Input	Output				
Input/Output Module	AS16AP11R-A	16 (8 in/8 out)	24 V _{DC} 5 mA	240 V _{AC} 24 V _{DC} 2A	Removable terminal block	1.9W	Relay	CE/UL
	AS16AP11T-A	16 (8 in/8 out)		5~30 V _{DC} 0.5A		0.7 W	Transistor NPN (Sink)	
	AS16AP11P-A	16 (8 in/8 out)				0.7 W	Transistor PNP (Source)	

■ Analog I/O Module

Name	Model	Channel	Mode	Terminal Block Type	Power Consumption (Internal)	Specifications	Certification
Analog Input Module	AS04AD-A	4	1~5V 0~5V -5~5V 0~10V -10~10V 4~20mA 0~20mA -20~20mA	Removable terminal block	1.2W/2.5W	<ul style="list-style-type: none"> • Hardware resolution: 16-bit • Single channel on/off setting to enhance overall conversion efficiency • Conversion time: 2ms/channel • Wire break detection at 1~5V, 4~20mA modes 	CE/UL
	New AS08AD-B	8	1~5V 0~5V -5~5V 0~10V -10~10V				
	New AS08AD-C		4~20mA 0~20mA -20~20mA				
Analog Output Module	AS04DA-A	4	0~10V -10~10V 4~20mA 0~20mA		1.2W/3W	<ul style="list-style-type: none"> • Hardware resolution: 12-bit • Single channel on/off setting • Conversion time: 250µs/channel 	
Analog Input/Output Module	AS06XA-A	Input: 4 Output: 2	<ul style="list-style-type: none"> • Input: 1~5V, 0~5V, -5~5V, 0~10V, -10~10V, 4~20mA, 0~20mA, -20~20mA • Output: 0~10V, -10~10V, 4~20mA, 0~20mA 		1.2W/2.5W	<ul style="list-style-type: none"> • Input resolution: 16-bit • Output resolution: 12-bit • Single channel on/off setting to enhance overall conversion efficiency • Conversion time: 2ms/channel • Wire break detection at 1~5V, 4~20mA modes 	

Ordering Information

■ Temperature Measurement Module

Name	Model	Channel	Mode	Terminal Block Type	Power Consumption (Internal)	Specifications	Certification
RTD Temperature Measurement Module	AS04RTD-A	4	Pt100 Ni100 Pt1000 Ni1000 JPt100	Removable terminal block	2W/1W	<ul style="list-style-type: none"> Resolution 0.1°C/0.1°F Conversion time: 200 ms/channel Overall accuracy RTD: ±0.1% TC: ±0.5% Wire break detection Module monitoring, setting 	CE/UL
	New AS06RTD-A	6	LG-Ni1000 Cu50 Cu100 Input Impedance 0~300Ω 0~3,000Ω				
Thermocouple Temperature Measurement Module	AS04TC-A	4	J,K,R,S, T,E,N,B -100~+100mV				
	New AS08TC-A	8					

■ Load Cell Module

Name	Model	Channel	Mode	Terminal Block Type	Power Consumption (Internal)	Specifications	Certification
Load Cell Module	AS02LC-A	2	0~1 0~2 0~4 0~6 0~20 0~40 0~80 mV/V	Removable terminal block	0.75W/3W	<ul style="list-style-type: none"> Resolution: 24-bit for hardware (ADC), 32-bit for data output 4-wire/6-wire load cell sensor Selectable signal input ranges LCSofT software configuration High-speed dynamic measurement 50/60Hz active filtering 	CE/UL

■ Pulse Unit Module

Name	Model	Channel	Power Consumption (Internal)	Specifications	Certification
Pulse Unit Module	New AS02PU-A ^(*)	2	1.5 W	<ul style="list-style-type: none"> Differential 200 kHz Supports motion APIs 	CE/UL
	New AS04PU-A ^(*)	4	1.5 W	<ul style="list-style-type: none"> Open collector 200 kHz Supports motion APIs 	

Note 1: Please contact our distributors for release date

■ Function Cards

Name	Model	Channel	Specifications	Certification
Communication Card	AS-F232	1	Serial COM, RS-232 interface, slave/host mode	CE
	AS-F422	1	Serial COM, RS-422 interface, slave/host mode	
	AS-F485	1	Serial COM, RS-485 interface, slave/host mode	
	AS-FCOPM	1	<ul style="list-style-type: none"> CANopen port, support DS301, AS Series remote control or Delta servo motor control Built-in switchable terminal resistor (120 Ω) 	
	New AS-FEN02	1	Ethernet port, RJ45 x2 (Switch function), supports EtherNet/IP (Adapter mode)/Modbus TCP	
	New AS-FPFN02 ^(*)	1	PROFINET port, RJ45 x2 (Switch function), supports PROFINET (Slave mode)	
Analog I/O Card	AS-F2AD	2	2-channel analog input 0~10 V (12-bit resolution), 4~20 mA (11-bit resolution), conversion time: 3 ms/channel	
	AS-F2DA	2	2-channel analog Output 0~10 V, 4~20 mA (12-bit resolution), conversion time: 2 ms/channel	

Note 1: Please contact our distributors for release date

Ordering Information

■ Accessories

Name	Model	Descriptions	Specifications		Applicable Module
			Length	Connector/ Terminal Block Type	
I/O Cable	UC-ET010-24B	I/O cable for connecting I/O modules and external terminal modules	1 m	I/O extension cable (MIL connector IDC40 to IDC40) (Shielded)	AS32AM,AS64AM, AS32AN,AS64AN
	UC-ET010-24D		1 m	I/O extension cable (MIL connector IDC40 to IDC20 x2) (Shielded)	AS332T,AS332P, AS324MT,AS32AM, AS64AM,AS32AN, AS64AN
	UC-ET020-24B		2 m	I/O extension cable (MIL connector IDC40 to IDC40) (Shielded)	AS32AM,AS64AM, AS32AN,AS64AN
	UC-ET020-24D		2 m	I/O extension cable (MIL connector IDC40 to IDC20 x2) (Shielded)	AS332T,AS332P, AS324MT,AS32AM, AS64AM,AS32AN, AS64AN
	UC-ET030-24B		3 m	I/O extension cable (MIL connector IDC40 to IDC40) (Shielded)	AS32AM,AS64AM, AS32AN,AS64AN
	UC-ET030-24D		3 m	I/O extension cable (MIL connector IDC40 to IDC20 x2) (Shielded)	AS332T,AS332P, AS324MT,AS32AM, AS64AM,AS32AN, AS64AN
Cables	UC-DN01Z-01A ^(*)	CANopen / DeviceNet cables	305.0 m	Thick / Trunk Cable	AS200 CPU, AS01DNET-A TAP-CN01, TAP-CN02, TAP-CN03
	UC-DN01Z-02A ^(*)		305.0 m	Thin / Drop Cable	
	UC-CMC003-01A	CANopen / DeviceNet / DMCNET cables	0.3 m	RJ45	AS-FCOPM TAP-CN03
	UC-CMC005-01A		0.5 m	RJ45	
	UC-CMC010-01A		1.0 m	RJ45	
	UC-CMC015-01A		1.5 m	RJ45	
	UC-CMC020-01A		2.0 m	RJ45	
	UC-CMC030-01A		3.0 m	RJ45	
	UC-CMC050-01A		5.0 m	RJ45	
	UC-CMC100-01A		10.0 m	RJ45	
	UC-CMC200-01A		20.0 m	RJ45	

Note:

- Ordering unit: meter
- Not available in Taiwan

■ Accessories

Name	Model	Descriptions	Specifications		Applicable Module
			Length	Connector/ Terminal Block Type	
External terminal module	UB-10-ID16A	External terminal module of digital module	--	16 inputs or outputs (MIL connector, 20Pin)	AS332T, AS332P, AS324MT, AS32AM, 64AM, AS32AN, AS64AN
	UB-10-ID32A			32 inputs (MIL connector, 40Pin)	AS32AM, AS64AM
	UB-10-OT32A			32 transistor outputs (MIL connector, for NPN output)	AS32AN, AS64AN
	UB-10-OR16A			16 relay outputs (MIL connector, for NPN output)	AS332T, AS32AN02T, AS64AN02T
	UB-10-OR16B			16 relay outputs (MIL connector, for PNP output)	AS332P
	UB-10-IO32D			Connector converter (MIL→Spring)	AS332T, AS332P, AS324MT, AS32AM, AS32AN
Terminal resistors	TAP-TR01	CANopen/DeviceNet terminal resistors (RJ45)			
Distribution box	TAP-CP01	CANopen/DeviceNet distribution Box	--	Power distribution box	
	TAP-CN01		--	1 for 2	
	TAP-CN02		--	1 for 4	
	TAP-CN03		--	1 for 4 (RJ45)	
Auxiliary Connected Power Module	AS-ATXB	Move the CPU power connector from left side to bottom side			
PLC programming cable	UC-PRG015-01A	Communication cable for PLC to PC	1.5 m	PLC (mini USB)	All AS series CPU modules
	UC-PRG030-01A		3 m	PLC (mini USB)	
	UC-PRG030-20A	Communication cable for PLC/HMI (RJ45) to PC	3 m	PLC/HMI (RJ45)	

■ Starter Kit

Name	Model	Specifications
Delta PLC starter kit	UT-AS332-C	AS332T-A CPU, power module and other accessories



Smarter. Greener. Together.

Industrial Automation Headquarters

Delta Electronics, Inc.

Taoyuan Technology Center
No.18, Xinglong Rd., Taoyuan District,
Taoyuan City 33068, Taiwan
TEL: 886-3-362-6301 / FAX: 886-3-371-6301

Asia

Delta Electronics (Shanghai) Co., Ltd.

No.182 Minyu Rd., Pudong Shanghai, P.R.C.
Post code : 201209
TEL: 86-21-6872-3988 / FAX: 86-21-6872-3996
Customer Service: 400-820-9595

Delta Electronics (Japan), Inc.

Tokyo Office
Industrial Automation Sales Department
2-1-14 Shibadaimon, Minato-ku
Tokyo, Japan 105-0012
TEL: 81-3-5733-1155 / FAX: 81-3-5733-1255

Delta Electronics (Korea), Inc.

Seoul Office
1511, 219, Gasan Digital 1-Ro., Geumcheon-gu,
Seoul, 08501 South Korea
TEL: 82-2-515-5305 / FAX: 82-2-515-5302

Delta Energy Systems (Singapore) Pte Ltd.

4 Kaki Bukit Avenue 1, #05-04, Singapore 417939
TEL: 65-6747-5155 / FAX: 65-6744-9228

Delta Electronics (India) Pvt. Ltd.

Plot No.43, Sector 35, HSIIDC Gurgaon,
PIN 122001, Haryana, India
TEL: 91-124-4874900 / FAX : 91-124-4874945

Delta Electronics (Thailand) PCL.

909 Soi 9, Moo 4, Bangpoo Industrial Estate (E.P.Z),
Pattana 1 Rd., T.Phraksa, A.Muang,
Samutprakarn 10280, Thailand
TEL: 66-2709-2800 / FAX : 662-709-2827

Delta Energy Systems (Australia) Pty Ltd.

Unit 20-21/45 Normanby Rd., Notting Hill Vic 3168, Australia
TEL: 61-3-9543-3720

Americas

Delta Electronics (Americas) Ltd.

Raleigh Office
P.O. Box 12173, 5101 Davis Drive,
Research Triangle Park, NC 27709, U.S.A.
TEL: 1-919-767-3813 / FAX: 1-919-767-3969

Delta Greentech (Brasil) S/A

São Paulo Office
Rua Itapeva, 26 – 3º Andar - Bela Vista
CEP: 01332-000 – São Paulo – SP - Brasil
TEL: 55-11-3530-8642 / 55-11-3530-8640

Delta Electronics International Mexico S.A. de C.V.

Mexico Office
Vía Dr. Gustavo Baz No. 2160, Colonia La Loma,
54060 Tlalnepanitla Estado de Mexico
TEL: 52-55-2628-3015 #3050/3052

EMEA

Headquarters: Delta Electronics (Netherlands) B.V.

Sales: Sales.IA.EMEA@deltaww.com
Marketing: Marketing.IA.EMEA@deltaww.com
Technical Support: iatechnicalsupport@deltaww.com
Customer Support: Customer-Support@deltaww.com
Service: Service.IA.emea@deltaww.com
TEL: +31(0)40 800 3800

BENELUX: Delta Electronics (Netherlands) B.V.

De Witbogt 20, 5652 AG Eindhoven, The Netherlands
Mail: Sales.IA.Benelux@deltaww.com
TEL: +31(0)40 800 3800

DACH: Delta Electronics (Netherlands) B.V.

Coesterweg 45, D-59494 Soest, Germany
Mail: Sales.IA.DACH@deltaww.com
TEL: +49(0)2921 987 0

France: Delta Electronics (France) S.A.

ZI du bois Challand 2, 15 rue des Pyrénées,
Lisses, 91090 Evry Cedex, France
Mail: Sales.IA.FR@deltaww.com
TEL: +33(0)1 69 77 82 60

Iberia: Delta Electronics Solutions (Spain) S.L.U

Ctra. De Villaverde a Vallecas, 265 1º Dcha Ed.
Hormigueras – P.I. de Vallecas 28031 Madrid
TEL: +34(0)91 223 74 20

C/Llull, 321-329 (Edifici CINC) | 22@Barcelona, 08019 Barcelona

Mail: Sales.IA.Iberia@deltaww.com
TEL: +34 93 303 00 60

Italy: Delta Electronics (Italy) S.r.l.

Ufficio di Milano Via Senigallia 18/2 20161 Milano (MI)
Piazza Grazioli 18 00186 Roma Italy
Mail: Sales.IA.Italy@deltaww.com
TEL: +39 02 64672538

Russia: Delta Energy System LLC

Vereyskaya Plaza II, office 112 Vereyskaya str.
17 121357 Moscow Russia
Mail: Sales.IA.RU@deltaww.com
TEL: +7 495 644 3240

Turkey: Delta Greentech Elektronik San. Ltd. Sti. (Turkey)

Şerifali Mah. Hendem Cad. Kule Sok. No:16-A
34775 Ümraniye – İstanbul
Mail: Sales.IA.Turkey@deltaww.com
TEL: + 90 216 499 9910

GCC: Delta Energy Systems AG (Dubai BR)



P.O. Box 185668, Gate 7, 3rd Floor, Hamarain Centre
Dubai, United Arab Emirates
Mail: Sales.IA.MEA@deltaww.com
TEL: +971(0)4 2690148

Egypt + North Africa: Delta Electronics







511 Cairo Business Plaza, North 90 street,
New Cairo, Cairo, Egypt
Mail: Sales.IA.MEA@deltaww.com

Looking for pricing, stock, or lifecycle information?

Click below to explore more details on WIN SOURCE:

-  [View AS16AM10N-A on WIN SOURCE](#)
-  [Delta Electronics Information](#)

Optimize Your Supply Chain with WIN SOURCE Solutions

-  Global Sourcing Solution
-  Obsolete Management
-  Cost Control Management
-  Shortage Management
-  Alternative Solution
-  Excess Inventory Management