



# THE DATASHEET OF ARM21011DM



**Series: ARMADILLO**

**Description:** Vehicular Multiband Antenna with Direct Mount

**PART NUMBER: ARMXXXXDM**



**Features:**

- Low profile, only 1.8” tall
- Up to 6-lead Configuration
  - LTE(2x) MIMO
  - WiFi(3x) MIMO-|2.4/5.x GHz
  - GPS/GNSS (1x)
- Frequency of Operation:
  - 698-960MHz,1710-2690MHz
  - 2400-2500MHz,5150-5925MHz
  - 1559-1606MHz

**Applications:**

- Telematics, Navigation
- First Responders(Police, Fire, Ambulance/EMS)
- Energy, Utility, Construction
- Fleet Management
- DSRC(Dedicated Short Range Communications)
- Available Configurations:
  - Black, White
  - Direct, Magnetic, Adhes.Mount

Issue: 2034

In the effort to improve our products, we reserve the right to make changes judged to be necessary.

CONFIDENTIAL AND PROPRIETARY INFORMATION

This document contains confidential and proprietary information of Pulse Electronics, Inc. (Pulse) and is protected by copyright, trade secret and other state and federal laws. Its receipt or possession does not convey any rights to reproduce, disclose its contents, or to manufacture, use or sell anything it may describe. Reproduction, disclosure or use without specific written authorization of Pulse is strictly forbidden.

For more information:

Pulse Worldwide Headquarters  
15255 Innovation Drive #100  
San Diego, CA 92128  
USA  
Tel:1-858-674-8100

Pulse/Larsen Antennas  
18110 SE 34<sup>th</sup> St Bldg 2 Suite 250  
Vancouver, WA 98683  
USA  
Tel: 1-360-944-7551

Europe Headquarters  
Pulse GmbH & Do, KG  
Zeppelinstrasse 15  
Herrenberg, Germany  
Tel: 49 7032 7806 0

Pulse (Suzhou) Wireless Products Co, Inc.  
99 Huo Ju Road(#29 Bldg,4<sup>th</sup> Phase  
Suzhou New District  
Jiangsu Province, Suzhou 215009 PR China  
Tel: 86 512 6807 9998



Series: ARMADILLO

Description: Vehicular Multiband Antenna with Direct Mount

PART NUMBER: ARMXXXXDM

This document covers all product variants of the following product family

Product	Total Cable Leads	LTE Cable Leads	WiFi Cable Leads	GPS Cable Leads	Housing Color	Cable Length	Mounting
ARM62311DM	6	2 (with SMA Male)	3 (with RP-SMA Male)	1 (with SMA Male)	Black	17 FT or 5181mm	1. Direct Mount; 7/8" Hole Required 2. Mounting Surface thickness < 0.25"
ARM62312DM	6	2 (with SMA Male)	3 (with RP-SMA Male)	1 (with SMA Male)	White		
ARM52211DM	5	2 (with SMA Male)	2 (with RP-SMA Male)	1 (with SMA Male)	Black		
ARM52212DM	5	2 (with SMA Male)	2 (with RP-SMA Male)	1 (with SMA Male)	White		
ARM42111DM	4	2 (with SMA Male)	1 (with RP-SMA Male)	1 (with SMA Male)	Black		
ARM42112DM	4	2 (with SMA Male)	1 (with RP-SMA Male)	1 (with SMA Male)	White		
ARM32011DM	3	2 (with SMA Male)	0	1 (with SMA Male)	Black		
ARM32012DM	3	2 (with SMA Male)	0	1 (with SMA Male)	White		
ARM21011DM	2	1 (with SMA Male)	0	1 (with SMA Male)	Black		
ARM21012DM	2	1 (with SMA Male)	0	1 (with SMA Male)	White		
ARM21011DMTT	2	1 (with TNC Male)	0	1 (with TNC Male)	Black		
ARM22001DM	2	2 (with SMA Male)	0	0	Black		

Issue: 2034

In the effort to improve our products, we reserve the right to make changes judged to be necessary.

CONFIDENTIAL AND PROPRIETARY INFORMATION

This document contains confidential and proprietary information of Pulse Electronics, Inc. (Pulse) and is protected by copyright, trade secret and other state and federal laws. Its receipt or possession does not convey any rights to reproduce, disclose its contents, or to manufacture, use or sell anything it may describe. Reproduction, disclosure or use without specific written authorization of Pulse is strictly forbidden.

For more information:

Pulse Worldwide Headquarters  
15255 Innovation Drive #100  
San Diego, CA 92128  
USA  
Tel: 1-858-674-8100

Pulse/Larsen Antennas  
18110 SE 34<sup>th</sup> St Bldg 2 Suite 250  
Vancouver, WA 98683  
USA  
Tel: 1-360-944-7551

Europe Headquarters  
Pulse GmbH & Do, KG  
Zeppelinstrasse 15  
Herrenberg, Germany  
Tel: 49 7032 7806 0

Pulse (Suzhou) Wireless Products Co, Inc.  
99 Huo Ju Road(#29 Bldg,4<sup>th</sup> Phase  
Suzhou New District  
Jiangsu Province, Suzhou 215009 PR China  
Tel: 86 512 6807 9998



**Description:** Vehicular Multiband Antenna with Direct Mount

**Series:** ARMADILLO

**PART NUMBER:** ARMXXXXDM

This document covers all product variants of the following product family

Product Numbering

Vehicular Multiband Antenna with Direct Mount



<b>1</b>	Product ID: ARMADILLO
<b>2</b>	Total Number of Cable leads
<b>3</b>	Total Number of LTE Cable Leads
<b>4</b>	Total Number of WiFi Cable Leads
<b>5</b>	Total Number of GPS Cable Leads
<b>6</b>	The Color of the Plastic Housing 1=Black; 2= White
<b>7</b>	Mounting: Direct Mount; 7/8" Hole Required

Issue: 2034

In the effort to improve our products, we reserve the right to make changes judged to be necessary.

CONFIDENTIAL AND PROPRIETARY INFORMATION

This document contains confidential and proprietary information of Pulse Electronics, Inc. (Pulse) and is protected by copyright, trade secret and other state and federal laws. Its receipt or possession does not convey any rights to reproduce, disclose its contents, or to manufacture, use or sell anything it may describe. Reproduction, disclosure or use without specific written authorization of Pulse is strictly forbidden.

For more information:

Pulse Worldwide Headquarters  
15255 Innovation Drive #100  
San Diego, CA 92128  
USA  
Tel: 1-858-674-8100

Pulse/Larsen Antennas  
18110 SE 34<sup>th</sup> St Bldg 2 Suite 250  
Vancouver, WA 98683  
USA  
Tel: 1-360-944-7551

Europe Headquarters  
Pulse GmbH & Do, KG  
Zeppelinstrasse 15  
Herrenberg, Germany  
Tel: 49 7032 7806 0

Pulse (Suzhou) Wireless Products Co, Inc.  
99 Huo Ju Road(#29 Bldg,4<sup>th</sup> Phase  
Suzhou New District  
Jiangsu Province, Suzhou 215009 PR China  
Tel: 86 512 6807 9998



**Description:** Vehicular Multiband Antenna with Direct Mount

**Series:** ARMADILLO

**PART NUMBER:** ARMXXXXDM

**ELECTRICAL SPECIFICATIONS**

Frequency	698-960MHz, 1710-2690MHz 2400-2500MHz, 5150-5925MHz
Nominal Impedance	50 Ω
VSWR*	
698-960MHz	<2.5
1710-2690MHz	<2.5
2400-2500MHz	<2
5150-5925MHz	<2
Isolation*	
698-960MHz, 1710-2690MHz	-8dB
2400-2500MHz, 5150-5925MHz	-12dB
Average Peak Gain**	
698-960MHz;	4.9dBi
1710-2690MHz	5.3dBi
2400-2500MHz	4.6dBi
5150-5925MHz	6.6dBi
Polarization	Vertical

\*Test on 500mm ground plane with 17ft(5.2m) LMR195 cable

\*\*Test on 500mm ground plane with 1ft(304.8) LMR195 cable

**Description:** Vehicular Multiband Antenna with Direct Mount

**Series:** ARMADILLO

**PART NUMBER:** ARMXXXXDM

**ELECTRICAL SPECIFICATIONS**

GPS Antenna	
Frequency	1561.098±2.046MHz/ 1575.42±1.023MHz/ 1602.5625±4MHz
Nominal Impedance	50 Ω
VSWR	<2
Gain (Radiating Element)	1 dBic±1 dB
Gain (LNA Gain)	30 dB± 2 dB
Polarization	RHCP
Out of Band Rejection	
698 MHz	>70 dB
960 MHz	>65 dB
1710 MHz	>60 dB
2170 MHz	>65 dB
2400 MHz	>65 dB
2700 MHz	>65 dB
Noise Figure	<2.4 dB
Operating Voltage	3.3 – 5 Vdc
Current Consumption	<15mA

**Description:** Vehicular Multiband Antenna with Direct Mount

**Series:** ARMADILLO

**PART NUMBER:** ARMXXXXDM

**MECHANICAL SPECIFICATIONS**

Overall Length	202.3mm X 88.5mm X 45mm
Weight	1.15 Kg
Antenna Color / Material	Black or White
Connector type	Refer to Page 2
Cable type	Refer to Page 2
Cable length	Refer to Page 2

**ENVIRONMENTAL SPECIFICATIONS**

Operating Temperature	-40 ~ +85° C
Storage Temperature	-40 ~ +85° C
Ingress Protection	IP67
RoHS Compliant	Yes

**OTHER SPECIFICATIONS**

Total cable assembly loss for 5.2m (17') LMR-195 @850MHz	2.1dB
Total cable assembly loss for 5.2m (17') LMR-100 @1575MHz	5.9dB
Total cable assembly loss for 5.2m (17') LMR-195 @1930MHz	3.2dB
Total cable assembly loss for 5.2m (17') LMR-195 @2450MHz	3.6dB
Total cable assembly loss for 5.2m (17') LMR-195 @2500MHz	3.7dB
Total cable assembly loss for 5.2m (17') LMR-195 @5350MHz	5.5dB

**Description:** Vehicular Multiband Antenna with Direct Mount

**Series:** ARMADILLO

**PART NUMBER:** ARMXXXXDM

**MECHANICAL DRAWING**

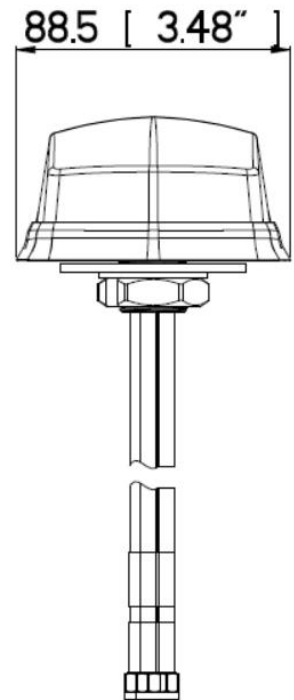
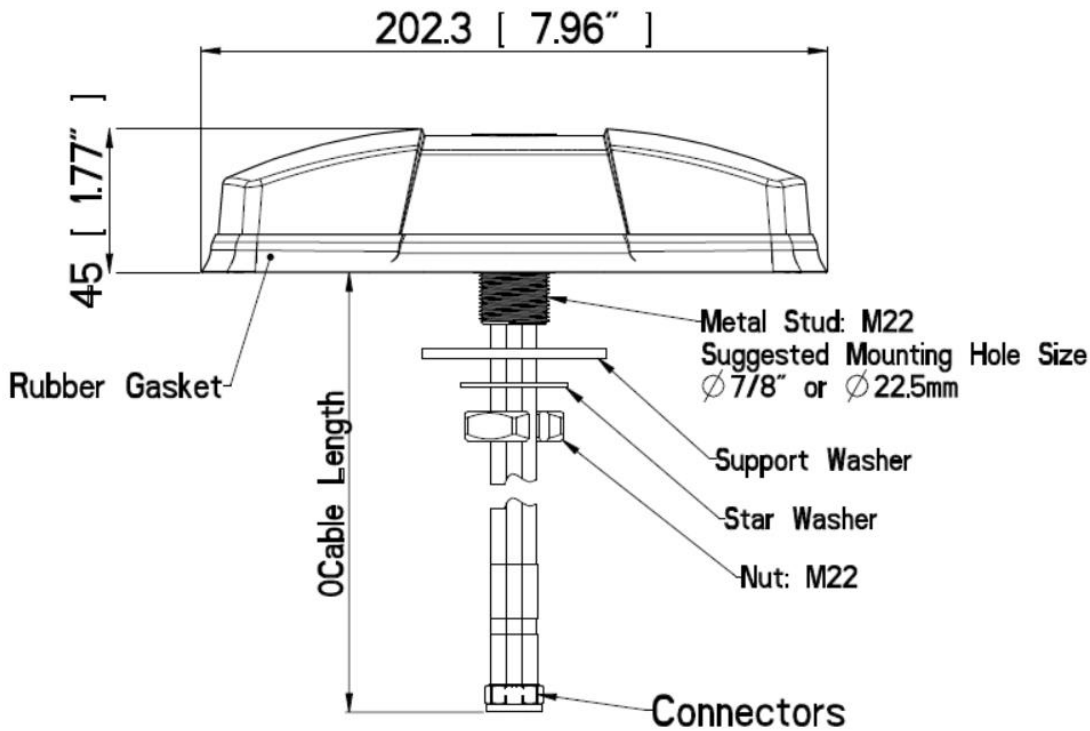
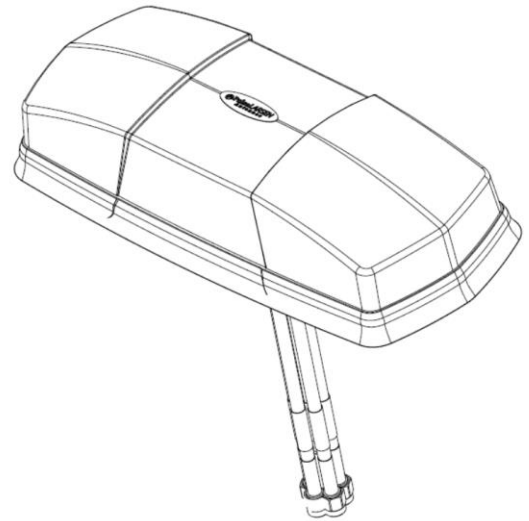
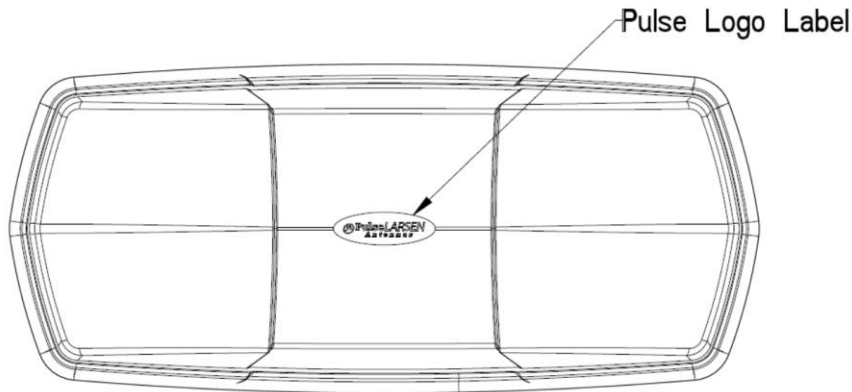

Issue: 2034

In the effort to improve our products, we reserve the right to make changes judged to be necessary.  
CONFIDENTIAL AND PROPRIETARY INFORMATION

This document contains confidential and proprietary information of Pulse Electronics, Inc. (Pulse) and is protected by copyright, trade secret and other state and federal laws. Its receipt or possession does not convey any rights to reproduce, disclose its contents, or to manufacture, use or sell anything it may describe. Reproduction, disclosure or use without specific written authorization of Pulse is strictly forbidden.

**Series: ARMADILLO**

**Description:** Vehicular Multiband Antenna with Direct Mount

**PART NUMBER: ARMXXXXDM**

**MECHANICAL DRAWING**

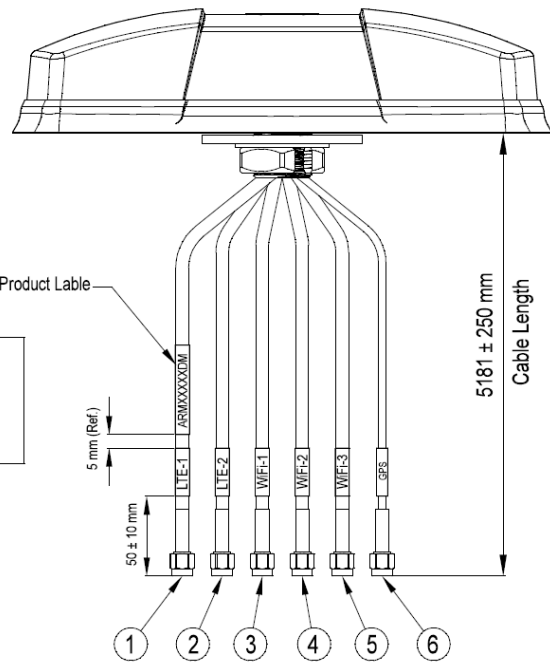

ARM62311DM		CABLE	CABLE LENGTH	CONNECTOR
1	LTE-1 Cable Assy	LMR-195 *	5181 mm / 204" / 17 FT	SMA Male
2	LTE-2 Cable Assy			
3	WiFi-1 Cable Assy			
4	WiFi-2 Cable Assy	LMR-195*		RP-SMA Male
5	WiFi-3 Cable Assy			
6	GPS Cable Assy	LMR-100*		SMA Male

\* or equivalent

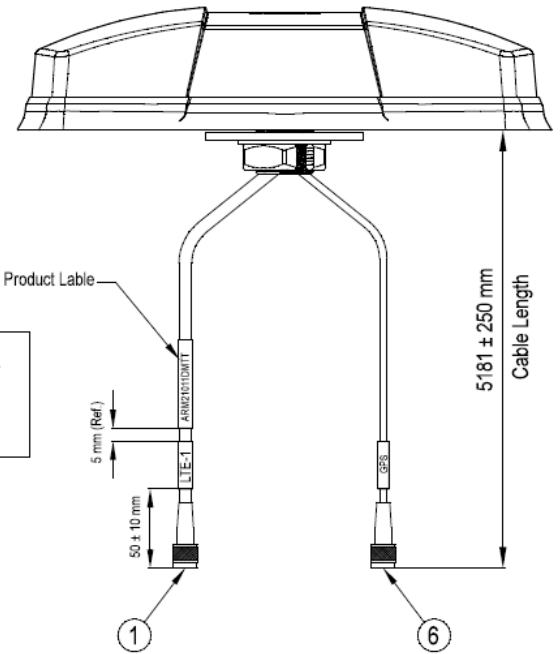

ARM21011DMTT		CABLE	CABLE LENGTH	CONNECTOR
1	LTE-1 Cable Assy	LMR-195 *	5181 mm / 204" / 17 FT	TNC Male
2				
3				
4				
5				
6	GPS Cable Assy	LMR-100*		TNC Male

\* or equivalent

Issue: 2034

In the effort to improve our products, we reserve the right to make changes judged to be necessary.

CONFIDENTIAL AND PROPRIETARY INFORMATION

This document contains confidential and proprietary information of Pulse Electronics, Inc. (Pulse) and is protected by copyright, trade secret and other state and federal laws. Its receipt or possession does not convey any rights to reproduce, disclose its contents, or to manufacture, use or sell anything it may describe. Reproduction, disclosure or use without specific written authorization of Pulse is strictly forbidden.

Series: ARMADILLO

**Description:** Vehicular Multiband Antenna with Direct Mount

**PART NUMBER:** ARMXXXXDM

### TEST SETUP

Antenna tested on a  $\varnothing 500\text{mm}$  ground plane.

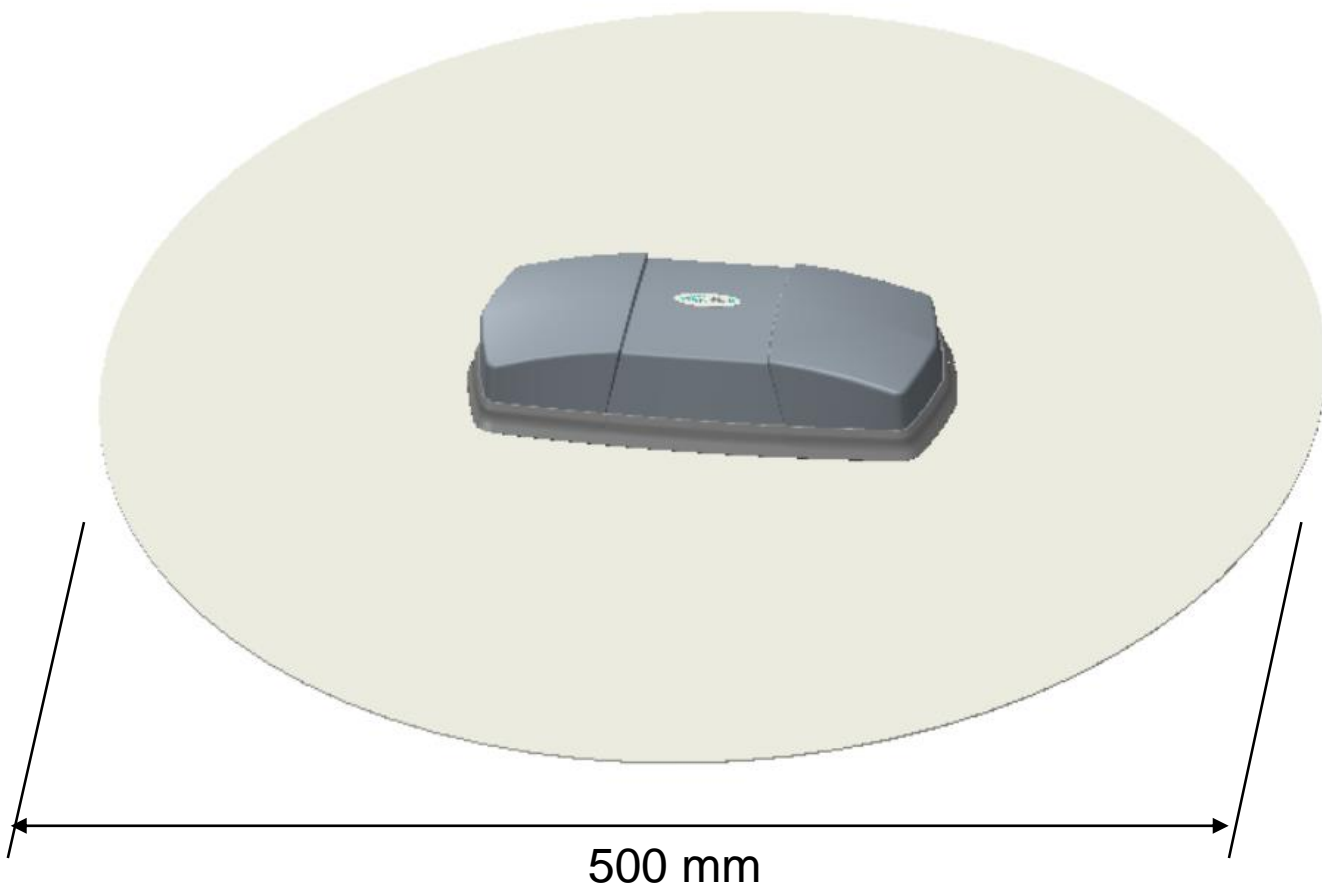

**Description:** Vehicular Multiband Antenna with Direct Mount

**Series:** ARMADILLO

**PART NUMBER:** ARMXXXXDM

**CHARTS**

**VSWR (LTE)**

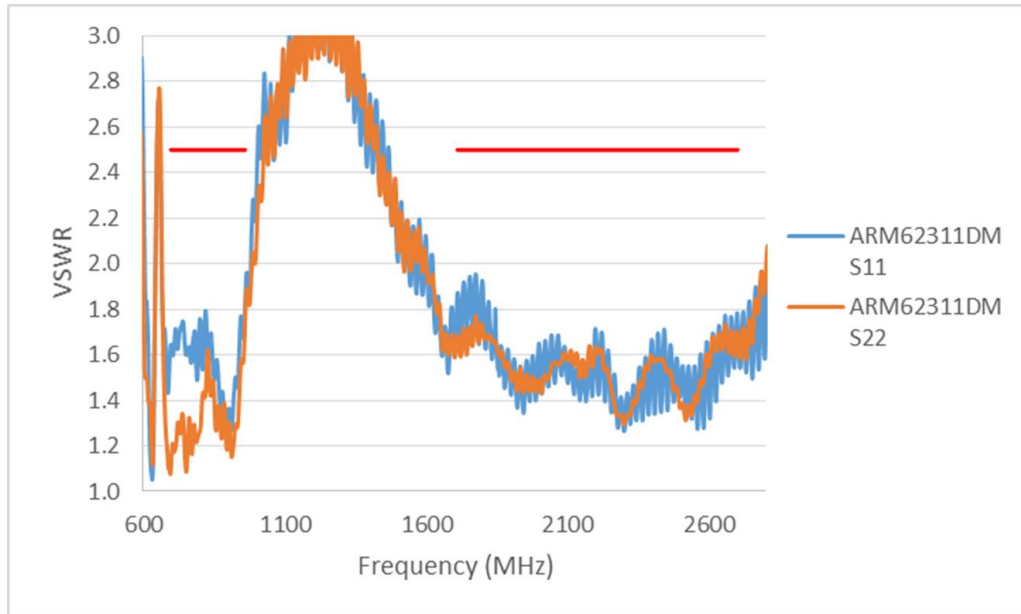

**Isolation (LTE)**

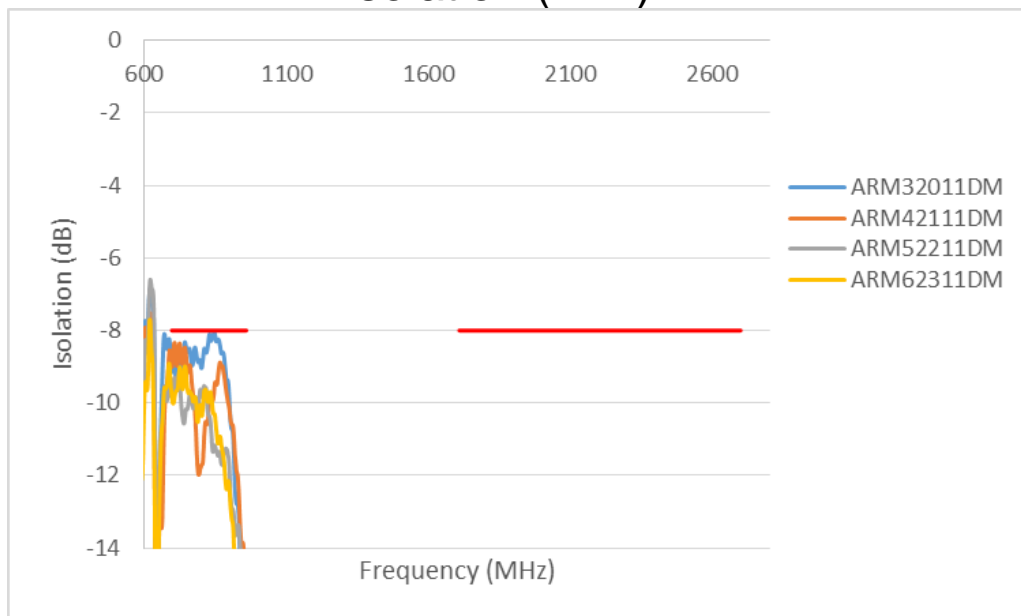

Note : Antenna tested with 5m cable on 500mm (dia) ground plane

Issue: 2034

In the effort to improve our products, we reserve the right to make changes judged to be necessary.

CONFIDENTIAL AND PROPRIETARY INFORMATION

This document contains confidential and proprietary information of Pulse Electronics, Inc. (Pulse) and is protected by copyright, trade secret and other state and federal laws. Its receipt or possession does not convey any rights to reproduce, disclose its contents, or to manufacture, use or sell anything it may describe. Reproduction, disclosure or use without specific written authorization of Pulse is strictly forbidden.

**Description:** Vehicular Multiband Antenna with Direct Mount

**Series:** ARMADILLO

**PART NUMBER:** ARMXXXXDM

**CHARTS**

**Radiation Efficiency (LTE)**

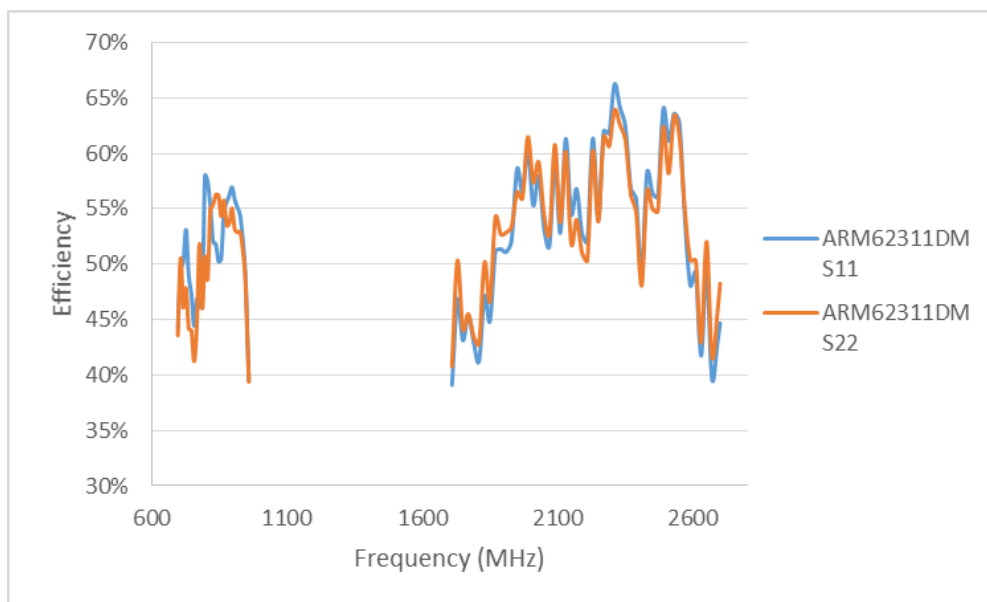

**Peak Gain (LTE)**

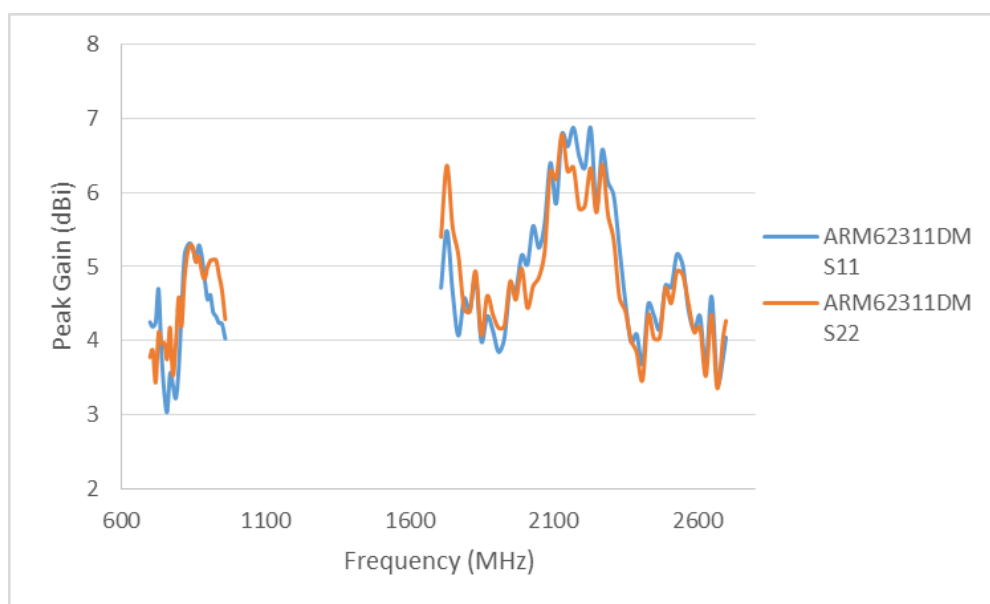

Note : Antenna tested with 1ft(304.8mm) cable on 500mm (dia) ground plane

Issue: 2034

In the effort to improve our products, we reserve the right to make changes judged to be necessary.

CONFIDENTIAL AND PROPRIETARY INFORMATION

This document contains confidential and proprietary information of Pulse Electronics, Inc. (Pulse) and is protected by copyright, trade secret and other state and federal laws. Its receipt or possession does not convey any rights to reproduce, disclose its contents, or to manufacture, use or sell anything it may describe. Reproduction, disclosure or use without specific written authorization of Pulse is strictly forbidden.

**Description:** Vehicular Multiband Antenna with Direct Mount

**Series:** ARMADILLO

**PART NUMBER:** ARMXXXXDM

**CHARTS**

**VSWR (WIFI)**

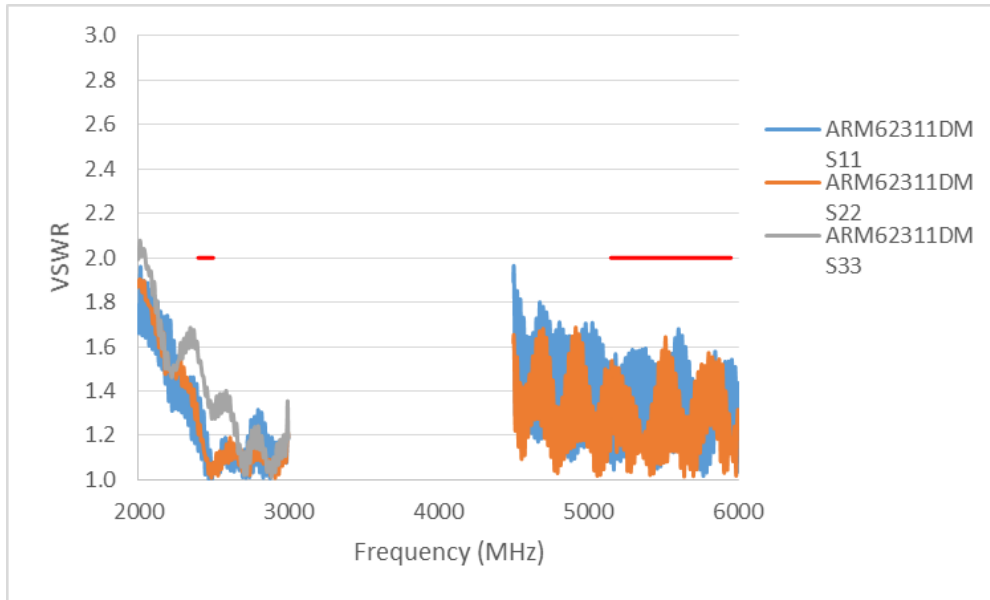

**Isolation (WIFI)**

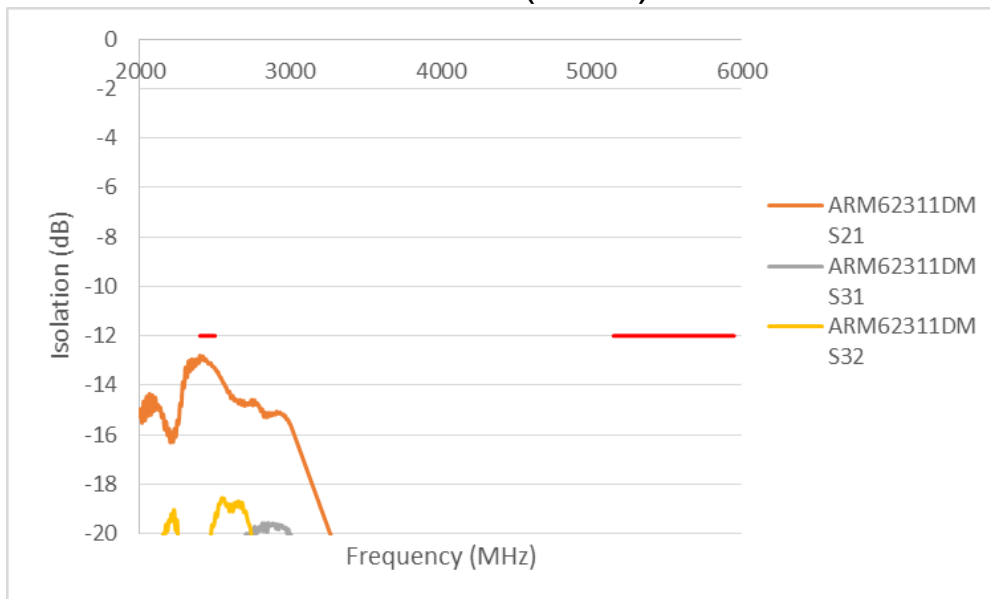

Note : Antenna tested with 5m cable on 500mm (dia) ground plane

Issue: 2034

In the effort to improve our products, we reserve the right to make changes judged to be necessary.

CONFIDENTIAL AND PROPRIETARY INFORMATION

This document contains confidential and proprietary information of Pulse Electronics, Inc. (Pulse) and is protected by copyright, trade secret and other state and federal laws. Its receipt or possession does not convey any rights to reproduce, disclose its contents, or to manufacture, use or sell anything it may describe. Reproduction, disclosure or use without specific written authorization of Pulse is strictly forbidden.

**Description:** Vehicular Multiband Antenna with Direct Mount

**Series:** ARMADILLO

**PART NUMBER:** ARMXXXXDM

**CHARTS**

**Radiation Efficiency (WIFI)**

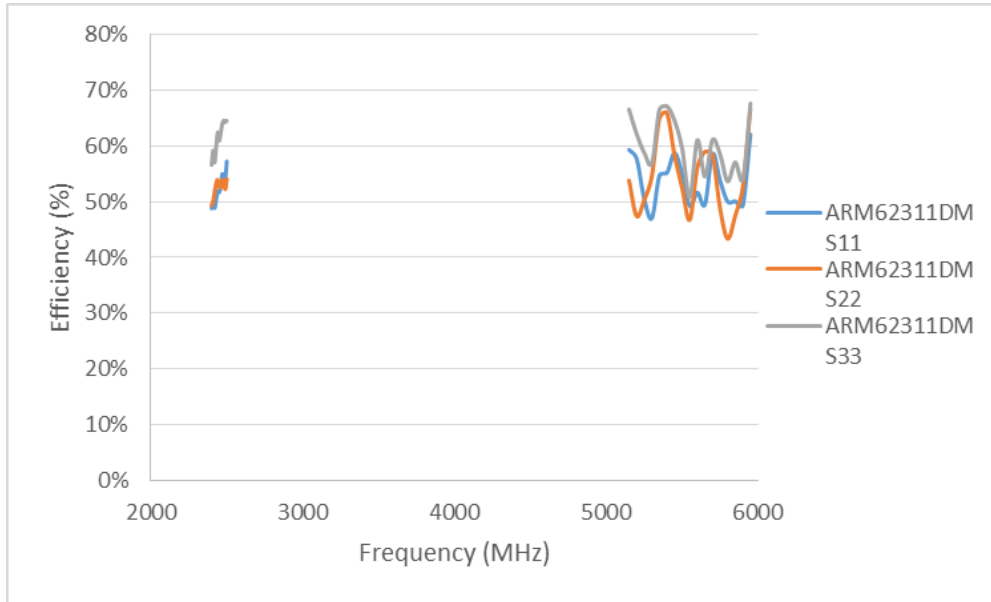

**Peak Gain (WIFI)**

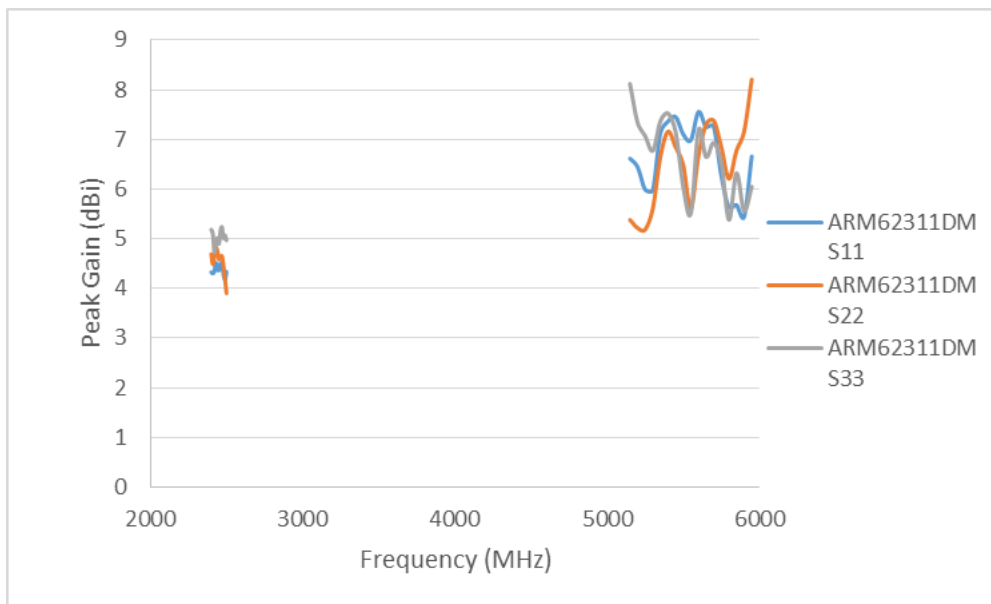

Note : Antenna tested with 1ft(304.8mm) cable on 500mm (dia) ground plane

Issue: 2034

In the effort to improve our products, we reserve the right to make changes judged to be necessary.

CONFIDENTIAL AND PROPRIETARY INFORMATION

This document contains confidential and proprietary information of Pulse Electronics, Inc. (Pulse) and is protected by copyright, trade secret and other state and federal laws. Its receipt or possession does not convey any rights to reproduce, disclose its contents, or to manufacture, use or sell anything it may describe. Reproduction, disclosure or use without specific written authorization of Pulse is strictly forbidden.

**Description:** Vehicular Multiband Antenna with Direct Mount

**Series:** ARMADILLO

**PART NUMBER:** ARMXXXXDM

**CHARTS**

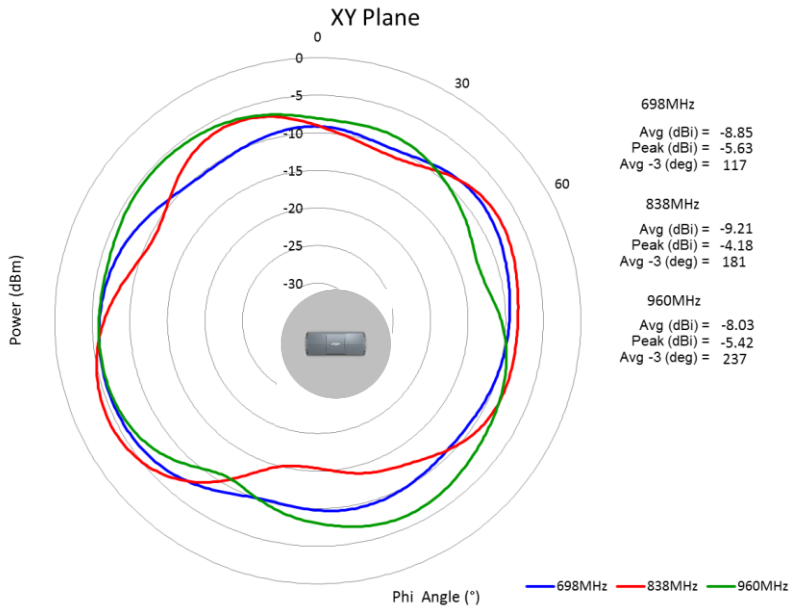

**LTE1 XY plane radiation pattern**

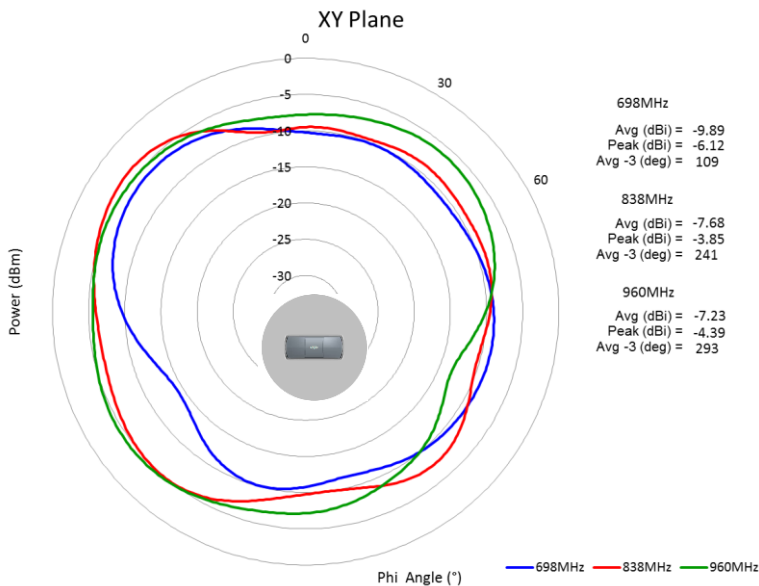

**LTE2 XY plane radiation pattern**

Issue: 2034

In the effort to improve our products, we reserve the right to make changes judged to be necessary.

CONFIDENTIAL AND PROPRIETARY INFORMATION

This document contains confidential and proprietary information of Pulse Electronics, Inc. (Pulse) and is protected by copyright, trade secret and other state and federal laws. Its receipt or possession does not convey any rights to reproduce, disclose its contents, or to manufacture, use or sell anything it may describe. Reproduction, disclosure or use without specific written authorization of Pulse is strictly forbidden.

**Description:** Vehicular Multiband Antenna with Direct Mount

**Series:** ARMADILLO

**PART NUMBER:** ARMXXXXDM

**CHARTS**

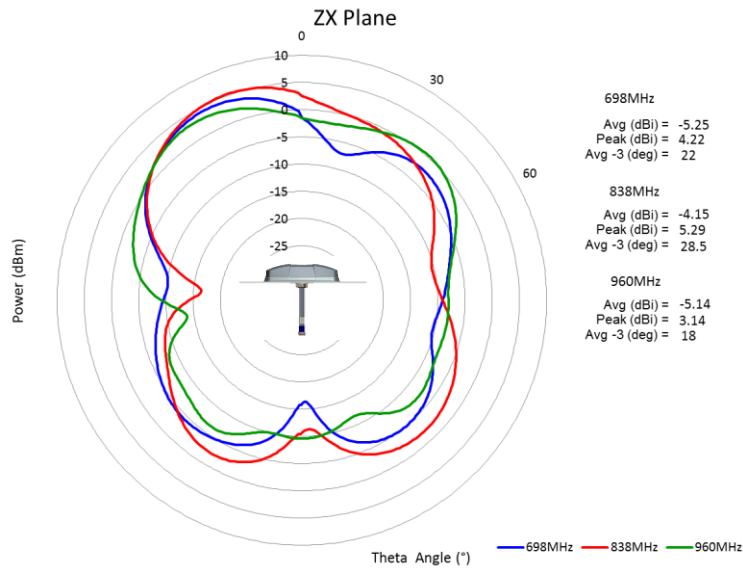

**LTE1 ZX plane radiation pattern**

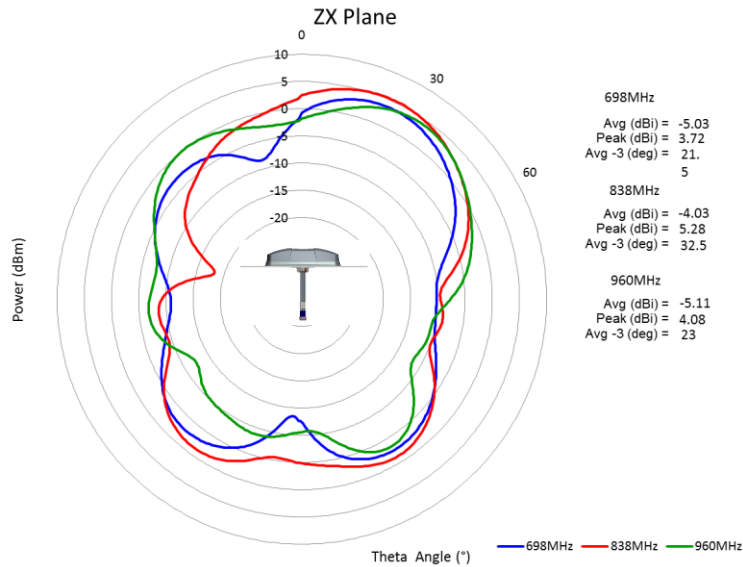

**LTE2 ZX plane radiation pattern**

Issue: 2034

In the effort to improve our products, we reserve the right to make changes judged to be necessary.

CONFIDENTIAL AND PROPRIETARY INFORMATION

This document contains confidential and proprietary information of Pulse Electronics, Inc. (Pulse) and is protected by copyright, trade secret and other state and federal laws. Its receipt or possession does not convey any rights to reproduce, disclose its contents, or to manufacture, use or sell anything it may describe. Reproduction, disclosure or use without specific written authorization of Pulse is strictly forbidden.

**Description:** Vehicular Multiband Antenna with Direct Mount

**Series:** ARMADILLO

**PART NUMBER:** ARMXXXXDM

**CHARTS**

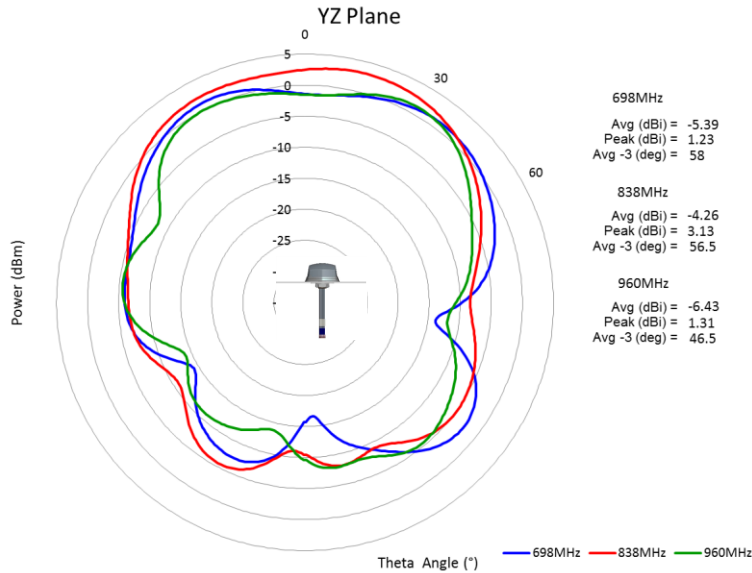

**LTE1 YZ plane radiation pattern**

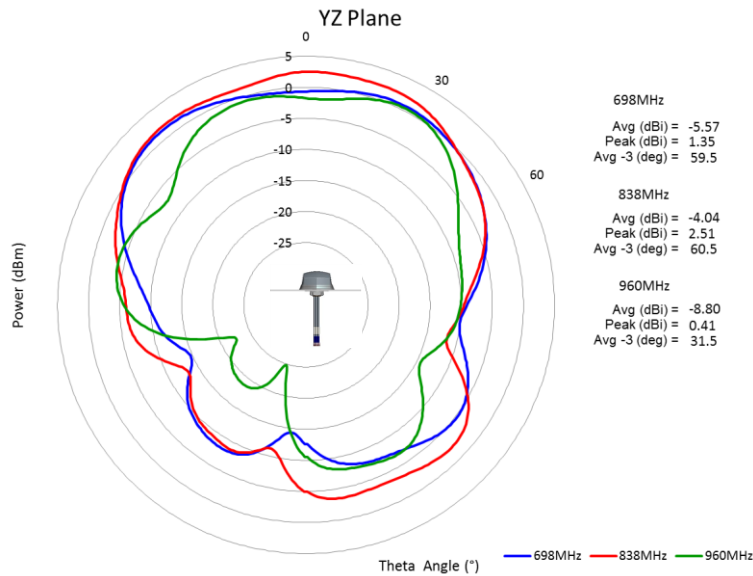

**LTE2 YZ plane radiation pattern**

Issue: 2034

In the effort to improve our products, we reserve the right to make changes judged to be necessary.

CONFIDENTIAL AND PROPRIETARY INFORMATION

This document contains confidential and proprietary information of Pulse Electronics, Inc. (Pulse) and is protected by copyright, trade secret and other state and federal laws. Its receipt or possession does not convey any rights to reproduce, disclose its contents, or to manufacture, use or sell anything it may describe. Reproduction, disclosure or use without specific written authorization of Pulse is strictly forbidden.

**Description:** Vehicular Multiband Antenna with Direct Mount

**Series:** ARMADILLO

**PART NUMBER:** ARMXXXXDM

**CHARTS**

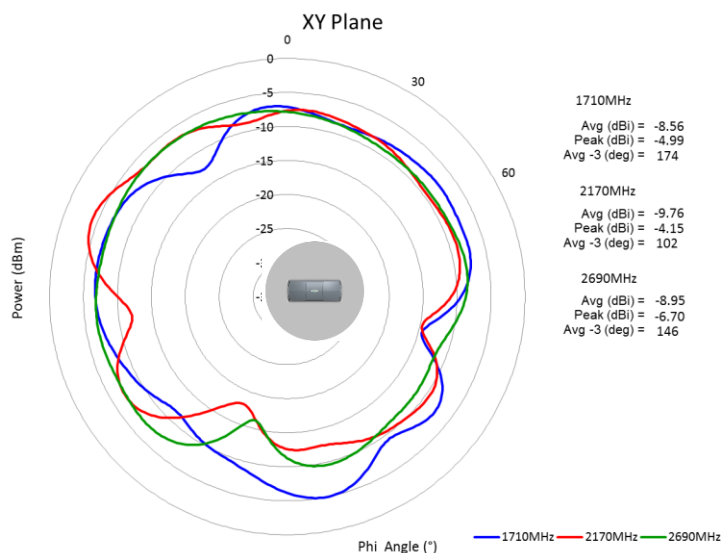

**LTE1 XY plane radiation pattern**

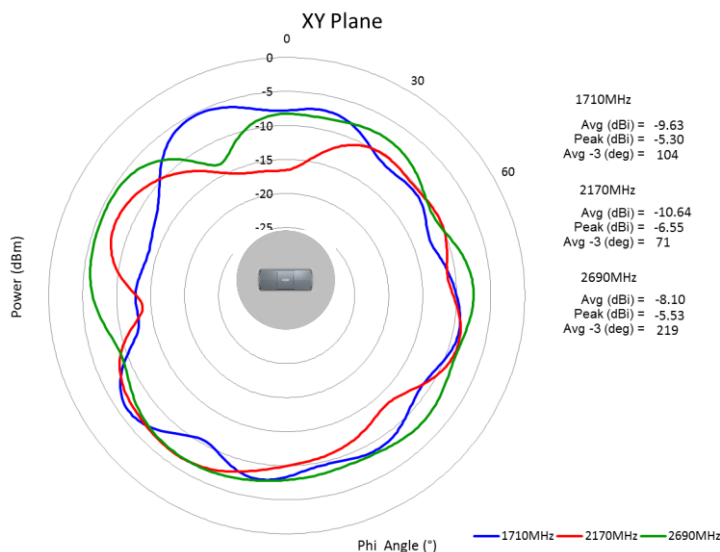

**LTE2 XY plane radiation pattern**

Issue: 2034

In the effort to improve our products, we reserve the right to make changes judged to be necessary.

CONFIDENTIAL AND PROPRIETARY INFORMATION

This document contains confidential and proprietary information of Pulse Electronics, Inc. (Pulse) and is protected by copyright, trade secret and other state and federal laws. Its receipt or possession does not convey any rights to reproduce, disclose its contents, or to manufacture, use or sell anything it may describe. Reproduction, disclosure or use without specific written authorization of Pulse is strictly forbidden.

**Description:** Vehicular Multiband Antenna with Direct Mount

**Series:** ARMADILLO

**PART NUMBER:** ARMXXXXDM

**CHARTS**

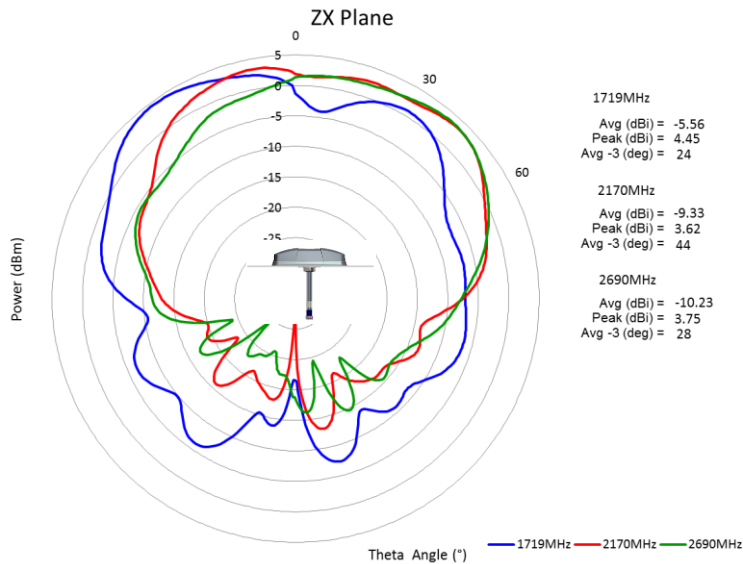

**LTE1 ZX plane radiation pattern**

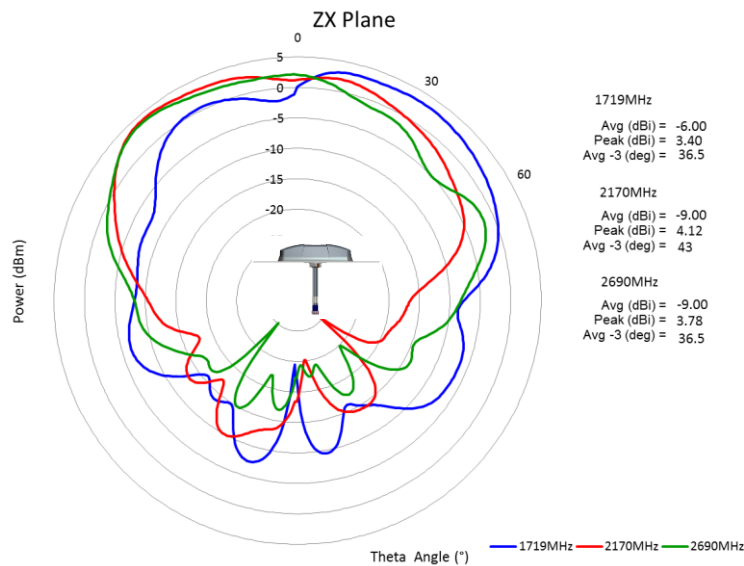

**LTE2 ZX plane radiation pattern**

Issue: 2034

In the effort to improve our products, we reserve the right to make changes judged to be necessary.

CONFIDENTIAL AND PROPRIETARY INFORMATION

This document contains confidential and proprietary information of Pulse Electronics, Inc. (Pulse) and is protected by copyright, trade secret and other state and federal laws. Its receipt or possession does not convey any rights to reproduce, disclose its contents, or to manufacture, use or sell anything it may describe. Reproduction, disclosure or use without specific written authorization of Pulse is strictly forbidden.

**Description:** Vehicular Multiband Antenna with Direct Mount

**Series:** ARMADILLO

**PART NUMBER:** ARMXXXXDM

**CHARTS**

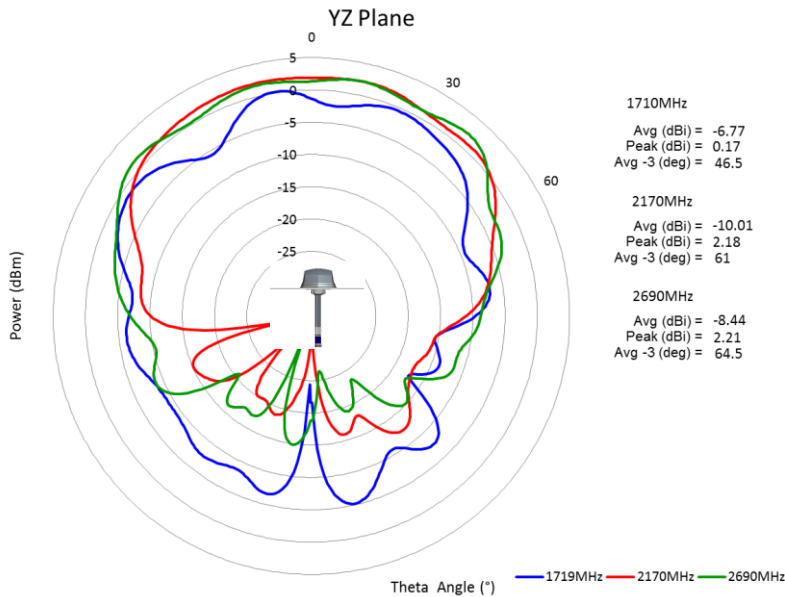

**LTE1 YZ plane radiation pattern**

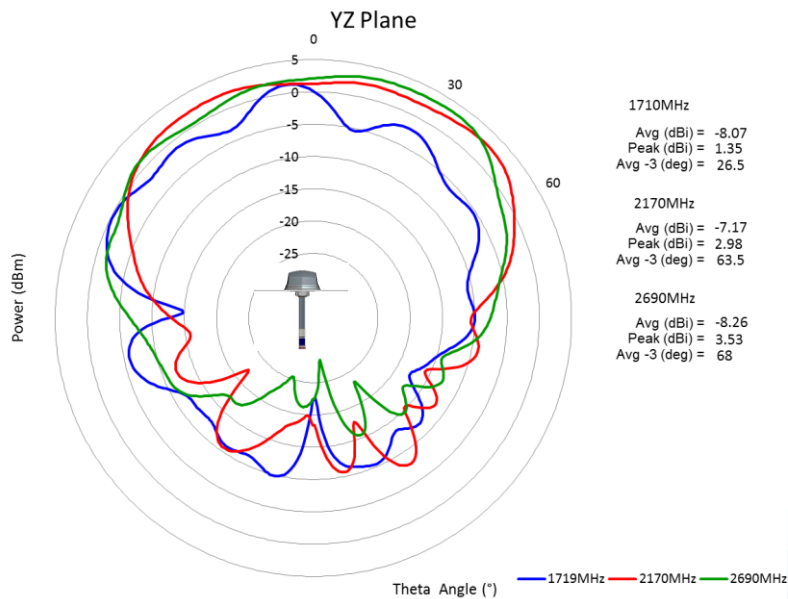

**LTE2 YZ plane radiation pattern**

Issue: 2034

In the effort to improve our products, we reserve the right to make changes judged to be necessary.

CONFIDENTIAL AND PROPRIETARY INFORMATION

This document contains confidential and proprietary information of Pulse Electronics, Inc. (Pulse) and is protected by copyright, trade secret and other state and federal laws. Its receipt or possession does not convey any rights to reproduce, disclose its contents, or to manufacture, use or sell anything it may describe. Reproduction, disclosure or use without specific written authorization of Pulse is strictly forbidden.

**Description:** Vehicular Multiband Antenna with Direct Mount

**Series:** ARMADILLO

**PART NUMBER:** ARMXXXXDM

**CHARTS**

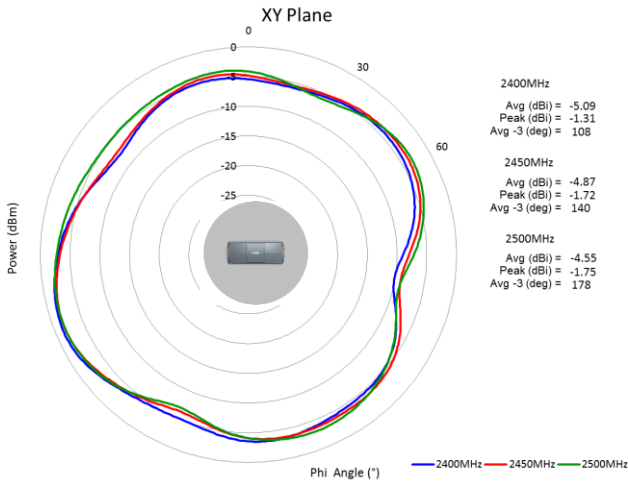

WiFi1 XY plane radiation pattern

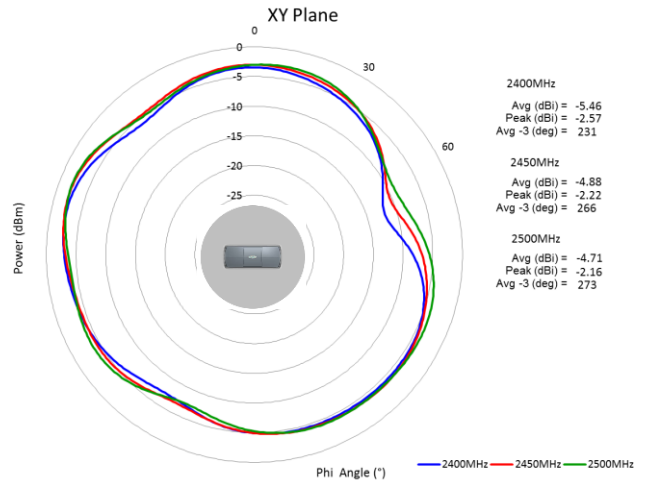

WiFi2 XY plane radiation pattern

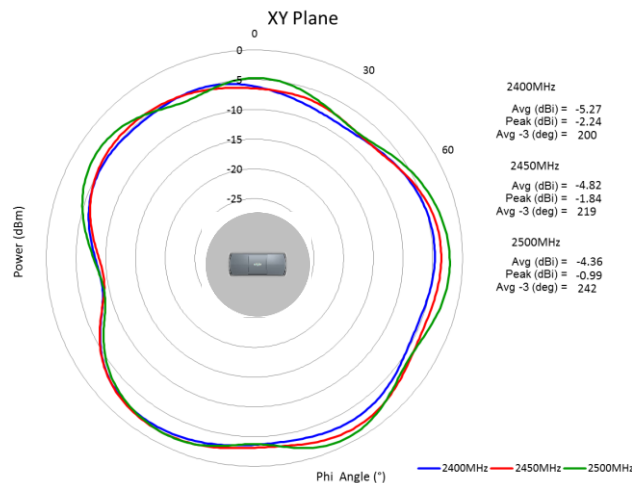

WiFi3 XY plane radiation pattern

Issue: 2034

In the effort to improve our products, we reserve the right to make changes judged to be necessary.

CONFIDENTIAL AND PROPRIETARY INFORMATION

This document contains confidential and proprietary information of Pulse Electronics, Inc. (Pulse) and is protected by copyright, trade secret and other state and federal laws. Its receipt or possession does not convey any rights to reproduce, disclose its contents, or to manufacture, use or sell anything it may describe. Reproduction, disclosure or use without specific written authorization of Pulse is strictly forbidden.

**Description:** Vehicular Multiband Antenna with Direct Mount

**Series:** ARMADILLO

**PART NUMBER:** ARMXXXXDM

**CHARTS**

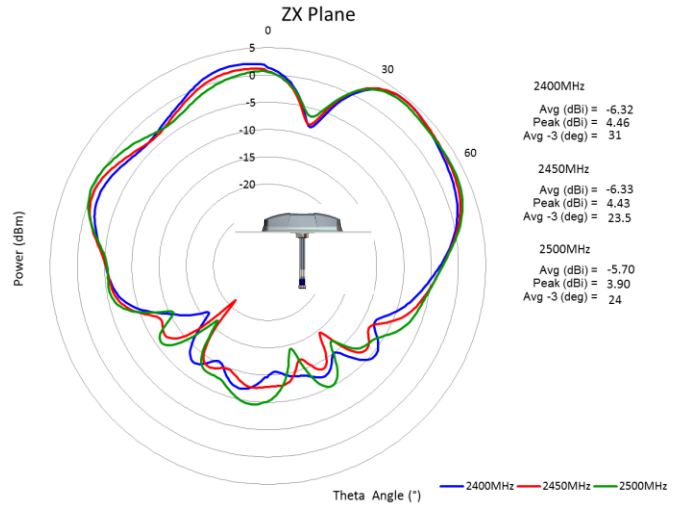
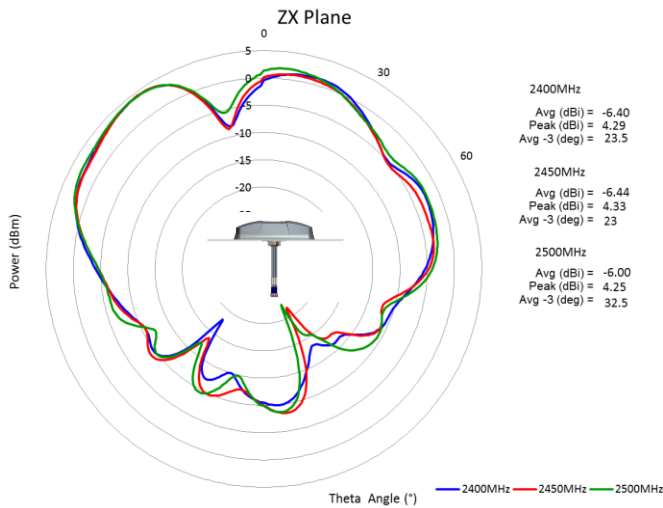

WiFi1 ZX plane radiation pattern

WiFi2 ZX plane radiation pattern

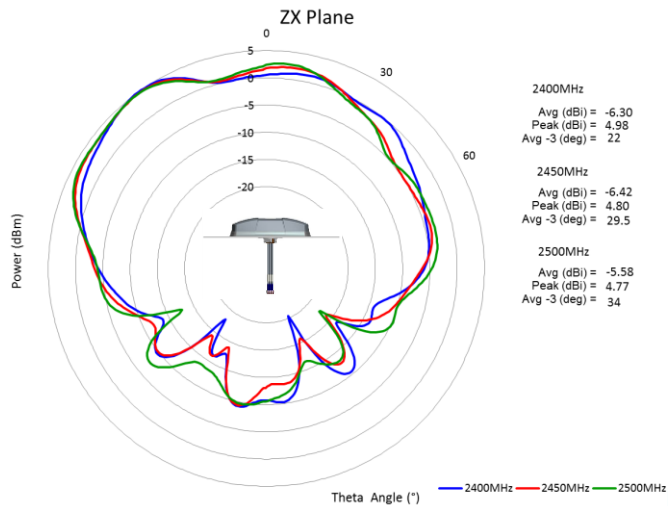

WiFi3 ZX plane radiation pattern

Issue: 2034

In the effort to improve our products, we reserve the right to make changes judged to be necessary.

CONFIDENTIAL AND PROPRIETARY INFORMATION

This document contains confidential and proprietary information of Pulse Electronics, Inc. (Pulse) and is protected by copyright, trade secret and other state and federal laws. Its receipt or possession does not convey any rights to reproduce, disclose its contents, or to manufacture, use or sell anything it may describe. Reproduction, disclosure or use without specific written authorization of Pulse is strictly forbidden.

**Description:** Vehicular Multiband Antenna with Direct Mount

**Series:** ARMADILLO

**PART NUMBER:** ARMXXXXDM

**CHARTS**

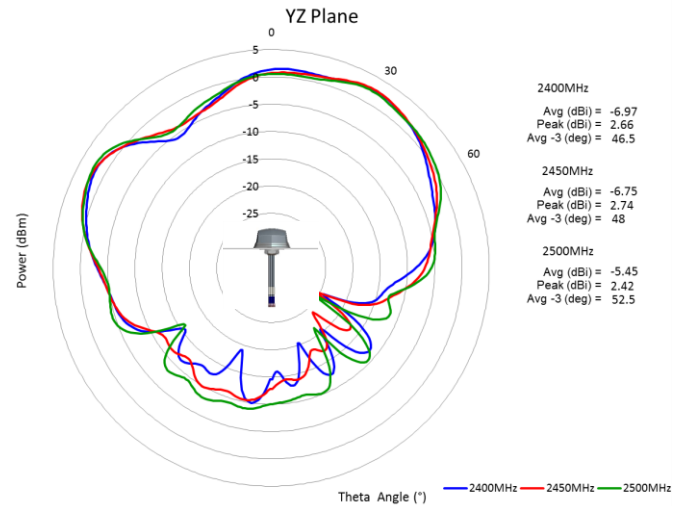
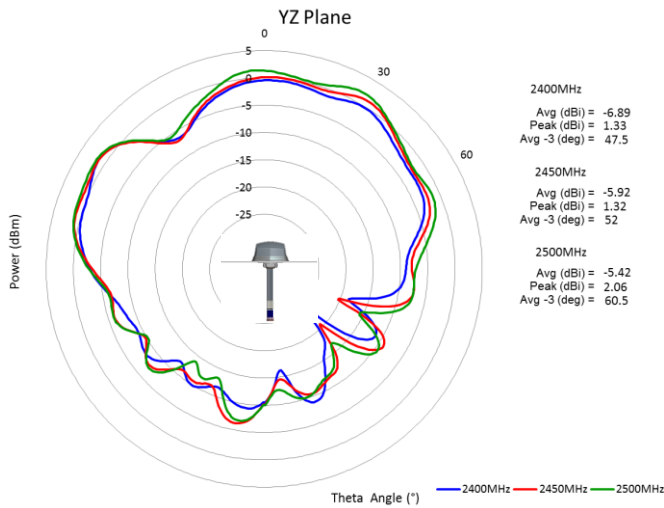

WiFi1 YZ plane radiation pattern

WiFi2 YZ plane radiation pattern

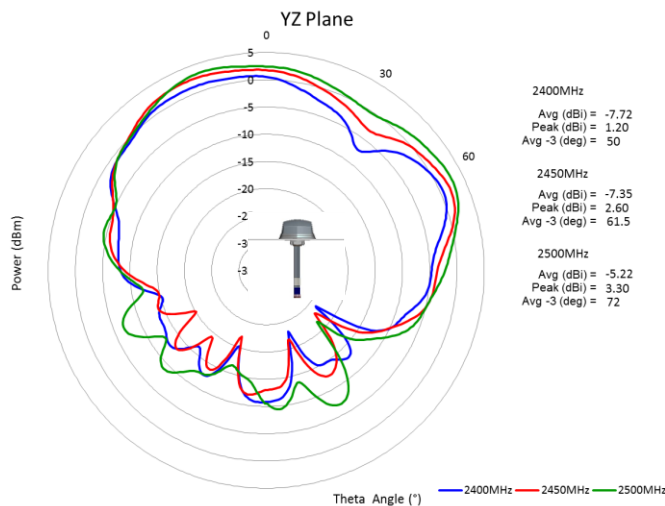

WiFi3 YZ plane radiation pattern

Issue: 2034

In the effort to improve our products, we reserve the right to make changes judged to be necessary.

CONFIDENTIAL AND PROPRIETARY INFORMATION

This document contains confidential and proprietary information of Pulse Electronics, Inc. (Pulse) and is protected by copyright, trade secret and other state and federal laws. Its receipt or possession does not convey any rights to reproduce, disclose its contents, or to manufacture, use or sell anything it may describe. Reproduction, disclosure or use without specific written authorization of Pulse is strictly forbidden.

**Description:** Vehicular Multiband Antenna with Direct Mount

**Series:** ARMADILLO

**PART NUMBER:** ARMXXXXDM

**CHARTS**

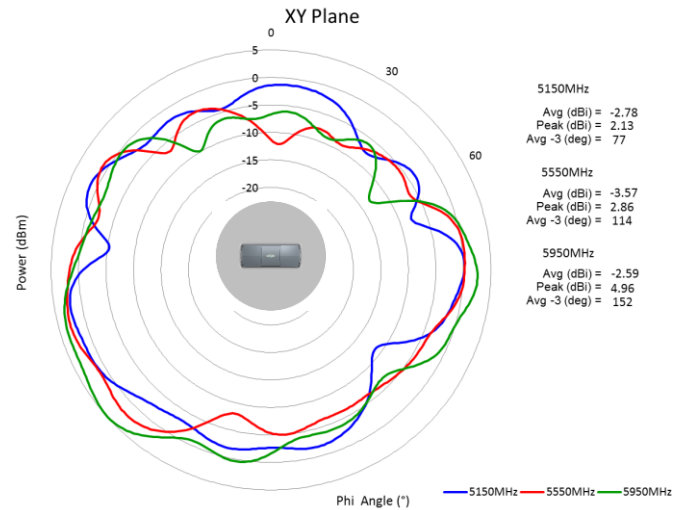
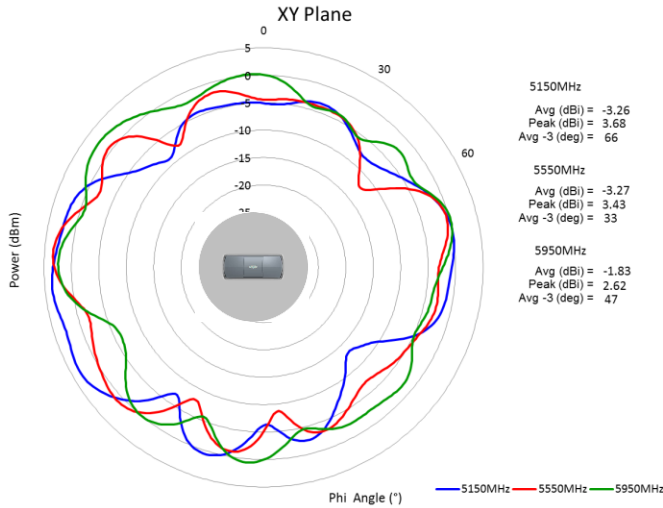

WiFi1 XY plane radiation pattern

WiFi2 XY plane radiation pattern

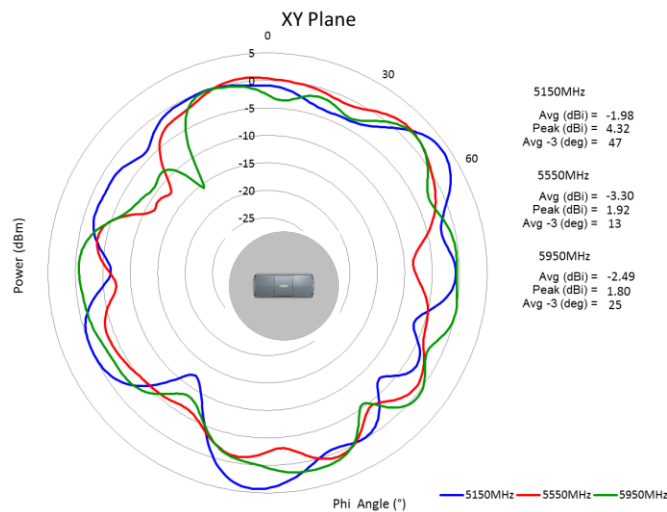

WiFi3 XY plane radiation pattern

Issue: 2034

In the effort to improve our products, we reserve the right to make changes judged to be necessary.

CONFIDENTIAL AND PROPRIETARY INFORMATION

This document contains confidential and proprietary information of Pulse Electronics, Inc. (Pulse) and is protected by copyright, trade secret and other state and federal laws. Its receipt or possession does not convey any rights to reproduce, disclose its contents, or to manufacture, use or sell anything it may describe. Reproduction, disclosure or use without specific written authorization of Pulse is strictly forbidden.

**Description:** Vehicular Multiband Antenna with Direct Mount

**Series:** ARMADILLO

**PART NUMBER:** ARMXXXXDM

**CHARTS**

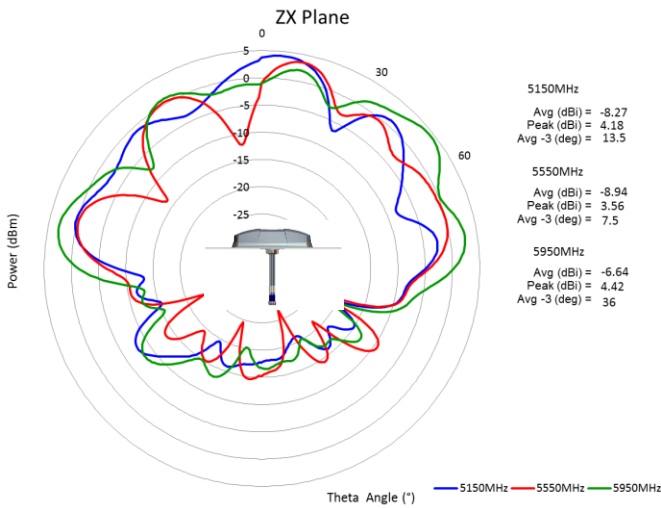

WiFi1 ZX plane radiation pattern

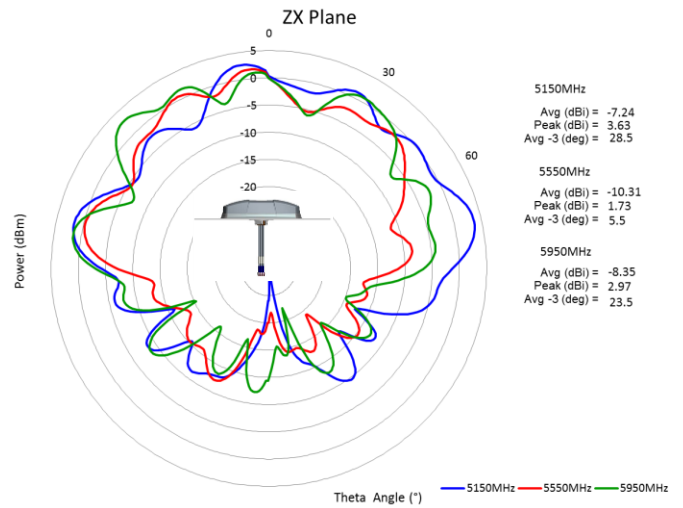

WiFi2 ZX plane radiation pattern

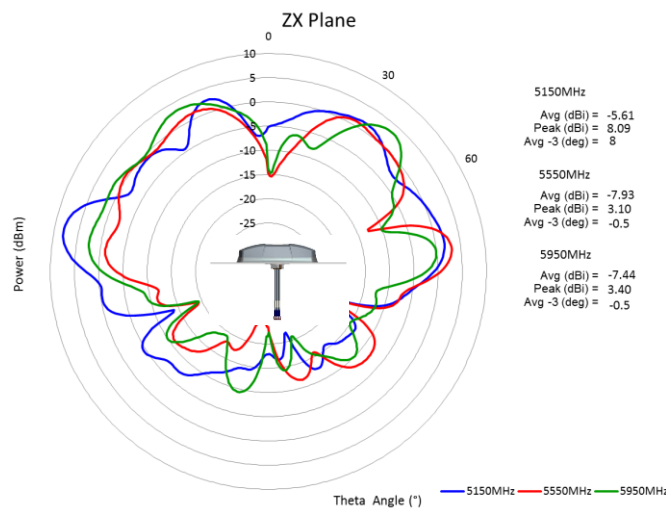

WiFi3 ZX plane radiation pattern

Issue: 2034

In the effort to improve our products, we reserve the right to make changes judged to be necessary.

CONFIDENTIAL AND PROPRIETARY INFORMATION

This document contains confidential and proprietary information of Pulse Electronics, Inc. (Pulse) and is protected by copyright, trade secret and other state and federal laws. Its receipt or possession does not convey any rights to reproduce, disclose its contents, or to manufacture, use or sell anything it may describe. Reproduction, disclosure or use without specific written authorization of Pulse is strictly forbidden.

**Description:** Vehicular Multiband Antenna with Direct Mount

**Series:** ARMADILLO

**PART NUMBER:** ARMXXXXDM

**CHARTS**

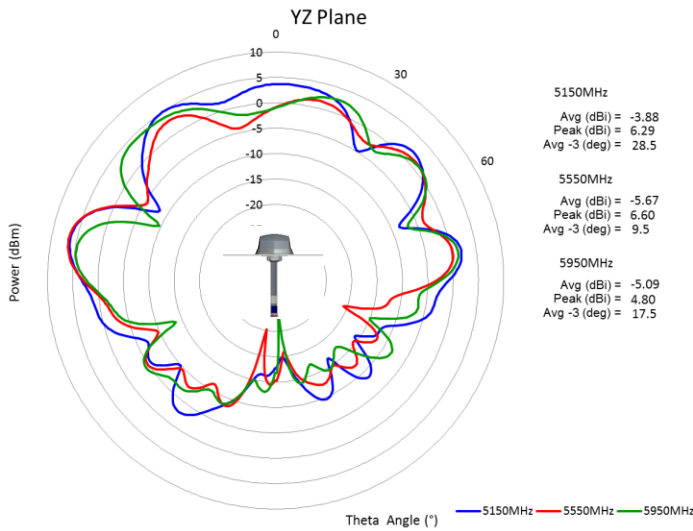

WiFi1 YZ plane radiation pattern

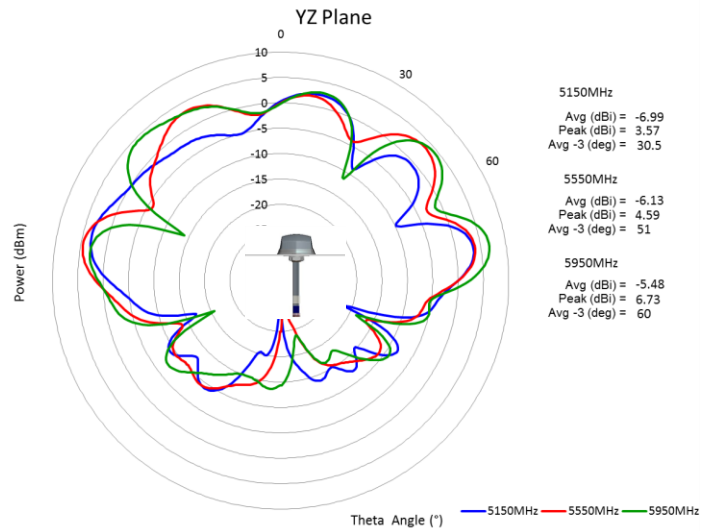

WiFi2 YZ plane radiation pattern

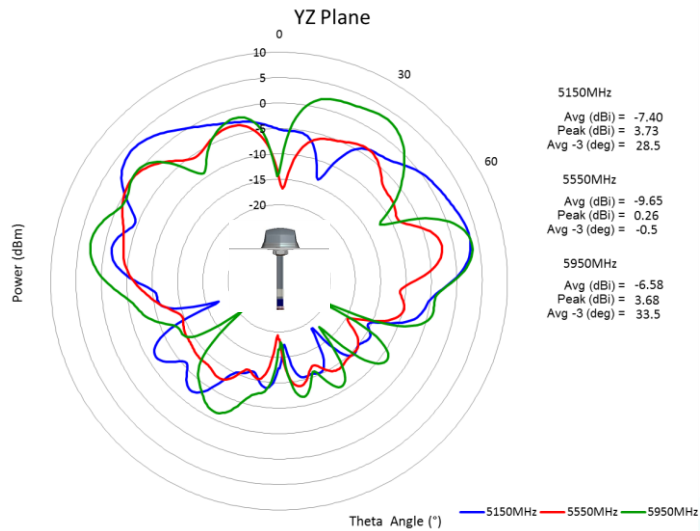

WiFi3 YZ plane radiation pattern

Issue: 2034

In the effort to improve our products, we reserve the right to make changes judged to be necessary.

CONFIDENTIAL AND PROPRIETARY INFORMATION

This document contains confidential and proprietary information of Pulse Electronics, Inc. (Pulse) and is protected by copyright, trade secret and other state and federal laws. Its receipt or possession does not convey any rights to reproduce, disclose its contents, or to manufacture, use or sell anything it may describe. Reproduction, disclosure or use without specific written authorization of Pulse is strictly forbidden.

**Series: ARMADILLO**

**Description:** Vehicular Multiband Antenna with Direct Mount

**PART NUMBER: ARMXXXXDM**

## PACKAGING

Each antennas packed in Bubble Bag

6 bags of antennas (Total 6pcs) packed in a cardboard box

1 label on each box with quantity, part number, date code.

## Looking for pricing, stock, or lifecycle information?

Click below to explore more details on WIN SOURCE:

- ⊖ [View ARM21011DM on WIN SOURCE](#)
- ⊖ [PulseLarsen Antennas Information](#)

## Optimize Your Supply Chain with WIN SOURCE Solutions

- ✓ Global Sourcing Solution
- ✓ Obsolete Management
- ✓ Cost Control Management
- ✓ Shortage Management
- ✓ Alternative Solution
- ✓ Excess Inventory Management