



**THE DATASHEET OF
APL111R-559-490**



AIRPAX®

APL/UPL Series
"Existing Design-In Only"





AIRPAX® | APL/UPL Series

Hydraulic Magnetic Circuit Protectors

INTRODUCTION

IMPORTANT NOTICE: *The APL/UPL is a legacy product and no new design-in orders are being accepted. We are also discontinuing the 205 series (APL with dust proof enclosure). If the specifications for any of these products are necessary for your system, Sensata Technologies recommends utilizing the Airpax™ IAL series.*

The APL/UPL magnetic circuit protector provides reliable, low-cost power switching, circuit protection and circuit control. The handle opens and closes a circuit, under normal load conditions, similar to an ON-OFF switch. Upon overload, the internal mechanism trips, opens the contacts and forcibly returns the handle to the OFF position. Since the protector is “trip free,” the internal contacts will not remain closed in the

presence of an overload, even though the handle is held in the ON position.

The APL/UPL line offers many configurations including series, shunt and relay with a choice of delays and ratings. APL/UPL multi-pole assemblies are available with a mix of current ratings, delays and internal circuit configurations.

While designed for industrial, military and information processing applications, the APL is suitable for use in any situation where precision operation is required. Most versions of the APL family are recognized by UL per UL STD. 1077 as supplementary protectors and certified by CSA per CSA STD. C22.2–No. 235 as supplementary protectors and are designated with the UPL prefix.

APL/UPL
Single Pole Toggle

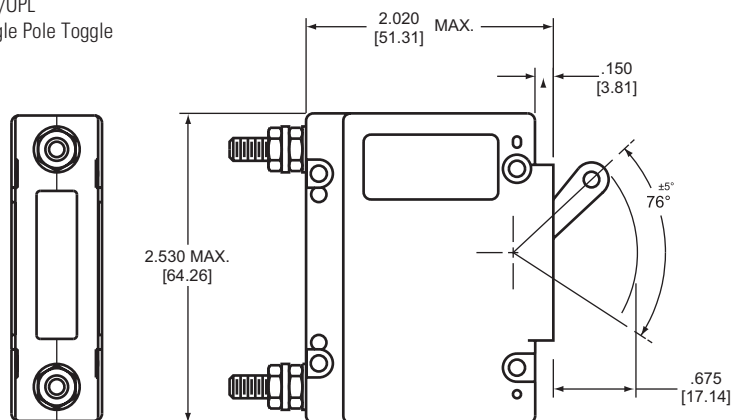

Note: Tolerance $\pm .015$ [.38] unless noted. Dimensions in brackets [] are millimeters.

MULTI-POLE CIRCUIT PROTECTORS

Multi-pole protectors are combined in an assembly with the actuating handles linked and the trip mechanisms internally coupled. A fault in either protected circuit opens all poles simultaneously. Applications include use in two-phase circuits, single-phase three-wire systems or in two or more related but electrically isolated circuits. A mix of delays, ratings and configurations is possible, with the series type having any of the auxiliary switches listed. Combinations up to nine poles are available.

MULTI-POLE DIMENSIONS

2 pole "A"	1.515 [38.48] max
3 pole "A"	2.265 [57.53] max
4 pole "A"	3.015 [76.58] max
5 pole "A"	3.765 [95.63] max
6 pole "A"	4.515 [114.68] max
7 pole "A"	5.265 [133.73] max
8 pole "A"	6.015 [152.78] max
9 pole "A"	6.765 [171.83] max

Note: Dimension "A" varies with # of poles

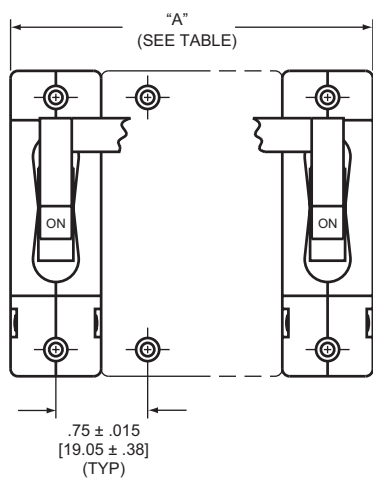

Mounting Details

One Pole

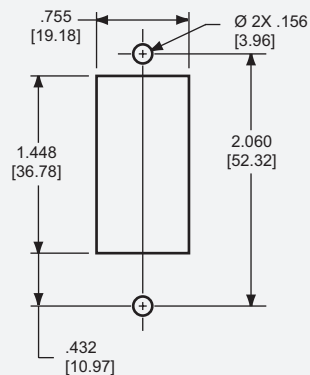

Two Pole

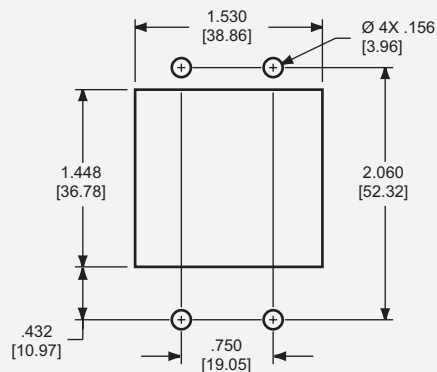

Three Pole

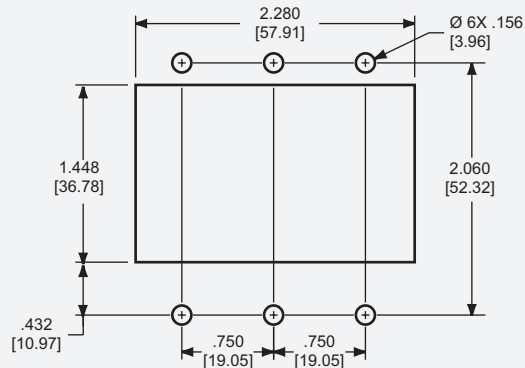

Panel Mounting Tolerances: ±.005 [.13] unless noted.

APL/UPL CONFIGURATIONS

Series Trip

The most popular configuration for magnetic protectors is the series trip where the sensing coil and contacts are in series with the load being protected. The handle position conveniently indicates circuit status. In addition to providing conventional over-current protection, it's simultaneously used as an on-off switch.

Auxiliary Switch

(Applies to Series Trip Only)

This is furnished as an integral part of a series pole in single or multi-pole assemblies. Isolated electrically from the protector's circuit, the switch works in unison with the power contacts and provides indication at a remote location of the protector's on-off status.

Auxiliary switch contacts actuate simultaneously with the main breaker contacts, and will open regardless of whether the breaker contacts are opened manually or electrically. For auxiliary switch ratings below 6Vac or 5Vdc, an auxiliary switch with gold contacts is available. Gold contacts are not recommended for load current above 100 milliamps.

The contacts on our optional RS auxiliary switch will open only in the event of an electrical trip of the circuit breaker.

Shunt Trip

The shunt trip is designed for controlling two separate loads with one assembly. The control is established by providing overload protection for the critical load. When the current through this load becomes excessive and reaches the trip point, the protector will open and remove power from both loads simultaneously. The total current rating of both loads must not exceed the maximum contact rating.

Relay Trip

This permits the overload sensing coil to be placed in a circuit which is electrically isolated from the trip contacts. The coil may be actuated by sensors monitoring pressure, flow, temperature, speed, etc. Other typical applications include crowbar, interlock and emergency/rapid shutdown circuitry. Trip may be accomplished by voltage or current, which must be removed immediately upon tripping.

Dual Coil

Dual coil protectors provide remote shut down option and normal overcurrent protection in the confines of a single breaker pole. This construction saves space by eliminating the need for an additional pole for the voltage trip function.

Voltage Trip

Sometimes called "dump circuits" or "panic trip circuits," these units make it possible to open main power contacts with lower power inputs from one or more sources. This configuration is becoming increasingly more important for sensitive circuitry and denser packaging in automation systems. Available in series, shunt, relay or dual coil configurations.



Series Trip (See Note A)

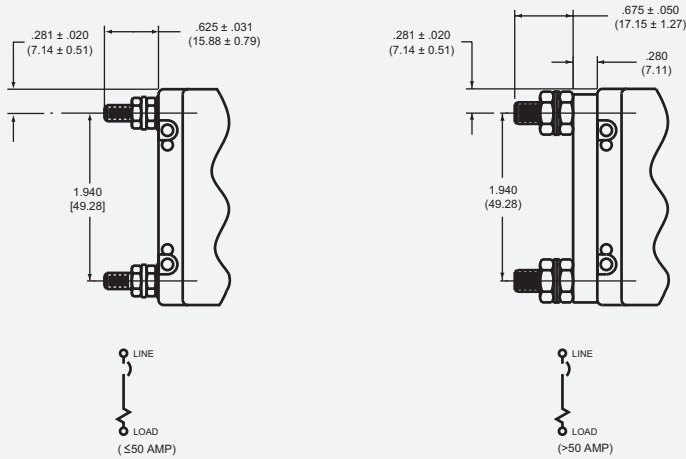

Series Trip with Auxiliary Switch

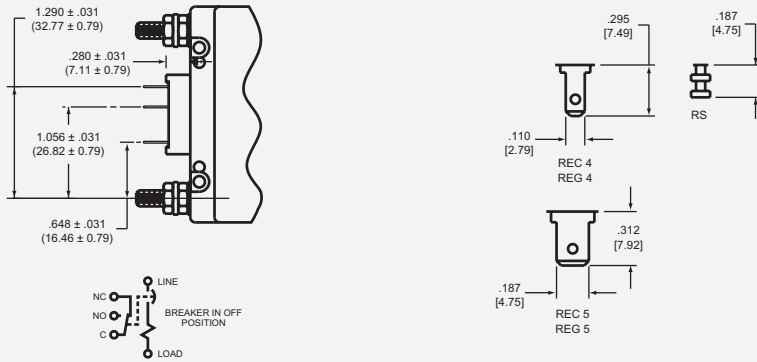

Shunt, Relay and Dual Coil

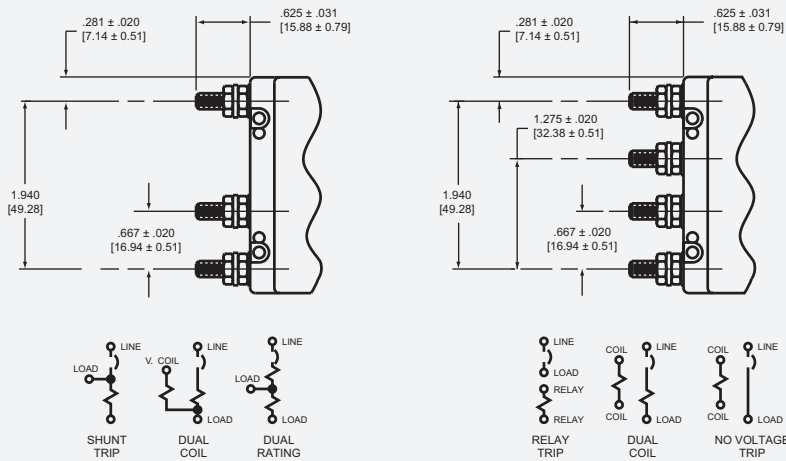

Notes:

Tolerance $\pm .015$ [.38] unless noted.
Dimensions in brackets [] are millimeters.

- A Terminal sizes: 10-32 THD (≤ 50 AMP), ¼ - 28 THD (≥ 50 AMP) Metric Terminals (Optional), M5 x 0.8 THD (≤ 50 AMP).
- B Minimum useable thread length: 10-32 THD (.250 on breakers without terminal boards, .160 with terminal boards) ¼ - 28 THD (.200).

APL/UPL OPERATING CHARACTERISTICS

0.050 AMPS TO 50 AMPS - PERCENTAGE OF RATED CURRENT VS TRIP TIME IN SECONDS AT +25°C									
Voltage	Delay	100%	125% (Note A)	150%	200%	400%	600%	800%	1000%
400 Hz	40	No Trip	May trip	.050 max.	.040 max.	.030 max.	.025 max.	.020 max.	.018 max.
	41	No Trip	May trip	.6 to 7	.2 to 2	.020 to .4	.007 to .25	.004 to .15	.004 to .040
	42	No Trip	May trip	5 to 70	2 to 22	.4 to 3.8	.015 to 2	.006 to .4	.004 to .1
	43	No Trip	May trip	40 to 280	9 to 70	1.3 to 15	.2 to 3.75	.023 to .6	.010 to .050
	49	No Trip	.180 max.	.120 max.	.050 max.	.022 max.	.017 max.	.017 max.	.017 max.
DC	50	No Trip	May trip	.032 max.	.024 max.	.020 max.	.018 max.	.016 max.	.015 max.
	51	No Trip	.70 to 8	.40 to 4	.1 to 1.7	.02 to .30	.008 to .15	.004 to .06	.004 to .030
	52	No Trip	8 to 100	3 to 30	.7 to 10	.18 to 2.5	.030 to 1	.004 to .5	.004 to .3
	53	No Trip	80 to 600	30 to 300	10 to 100	1.5 to 15	.1 to 5	.008 to .3	.007 to .07
	59	No Trip	.100 max.	.070 max.	.032 max.	.020 max.	.016 max.	.016 max.	.016 max.
50/60 Hz	60	No Trip	May trip	.040 max.	.035 max.	.030 max.	.025 max.	.020 max.	.018 max.
	61	No Trip	1 to 18	.4 to 4	.180 to 1.8	.03 to .3	.009 to .15	.003 to .1	.003 to .08
	62	No Trip	10 to 120	6 to 60	2 to 22	.2 to 2	.05 to .75	.015 to .15	.01 to .10
	69	No Trip	.180 max.	.120 max.	.050 max.	.022 max.	.017 max.	.017 max.	.017 max.
	64	No Trip	.7 to 10	.35 to 4.5	.15 to 1.5	.05 to .4	.025 to .3	.020 to .22	.015 to .15
	65	No Trip	8 to 80	5.5 to 55	2 to 20	.5 to 5	.2 to 2	.06 to 1	.016 to .60
	66	No Trip	50 to 700	30 to 350	10 to 100	1.5 to 20	.7 to 7	.1 to 3	.02 to 2
DC 50/60 Hz	70	No Trip	May trip	.040 max	.035 max.	.030 max.	.025 max.	.020 max.	.018 max.
	71	No Trip	.35 to 14	.18 to 7.5	.10 to 3	.025 to 1	.015 to .30	.01 to .15	.007 to .10
	72	No Trip	6.5 to 115	3 to 65	1.2 to 20	.08 to 3	.018 to 2.5	.015 to .80	.009 to .25
	73	No Trip	45 to 700	25 to 400	10 to 175	.75 to 20	.12 to 4.5	.025 to 1	.01 to .25
ABOVE 50 AMPS - PERCENTAGE OF RATED CURRENT VS TRIP TIME IN SECONDS AT +25°C									
Voltage	Delay	100%	125% (Note A)	150%	200%	400%	600%	800%	1000%
DC	50	No Trip	May trip	.100 max.	.070 max.	.032 max.	.020 max.	.020 max.	.020 max.
	51	No Trip	.5 to 8	.3 to 4	.1 to 1.7	.02 to .3	.08 to .150	.004 to .060	.004 to .03
	52	No Trip	2.5 to 100	1.5 to 40	.62 to 15	.15 to 2.5	.03 to 1	.004 to .5	.004 to .3
	59	No Trip	.100 max.	.070 max.	.032 max.	.020 max.	.016 max.	.016 max.	.016 max.
50/60 Hz	60	No Trip	May trip	.120 max.	.050 max.	.022 max.	.017 max.	.017 max.	.017 max.
	61	No Trip	.7 to 18	.35 to 4	.130 to 1.8	.030 to .3	.008 to .150	.003 to .1	.003 to .08
	62	No Trip	10 to 120	6 to 60	2 to 22	.2 to 2	.050 to .750	.007 to .15	.005 to .10
	69	No Trip	.180 max.	.120 max.	.050 max.	.022 max.	.017 max.	.017 max.	.017 max.
	64	No Trip	May trip	.2 to 8	.15 to 7.6	.05 to .73	.025 to .3	.020 to .22	.015 to .15
	65	No Trip	May trip	3 to 55	2 to 20	.3 to 5	.13 to 2	.06 to 1	.016 to .60

Notes: All trip curves and trip currents are specified with the protector mounted in the normal vertical position at ambient temperature of +25°C. Protectors do not carry current prior to application of overload. A: 130% for delays 49, 135% for delays 71, 72 and 73

Inrush Pulse Tolerance (typ)

The following table provides a comparison of inrush pulse tolerance with and without the inertial delay feature for each of the 50/60Hz delays. Pulse tolerance is defined as a single pulse of half sine wave peak current amplitude of 8 milliseconds duration that will not trip the circuit breaker.

All trip curves and trip currents are specified with the breaker mounted in the normal vertical position at ambient temperature of +25°C. Protectors do not carry current prior to application of overload.

PULSE TOLERANCES

Delay	Pulse Tolerance
61, 62	12 times (approx.) rated current
61F, 62F	20 times (approx.) rated current
64, 65, 66	20 times (approx.) rated current
64F, 65F, 66F	35 times (approx.) rated current

Note: These limits do not apply to dual coil and tapped coil units

60Hz Delay Curves (typ)

A choice of delays are offered for 60Hz applications. Delays 60 and 69 are fast acting non-delayed tripping to protect sensitive electronic equipment (not recommended where known inrush exists). Delay 61 has a short delay for general purpose applications. Delay 62 is long enough to start certain types of motors and most transformers and capacitor loads. Delay 63 is an extra long delay primarily for special motor applications.

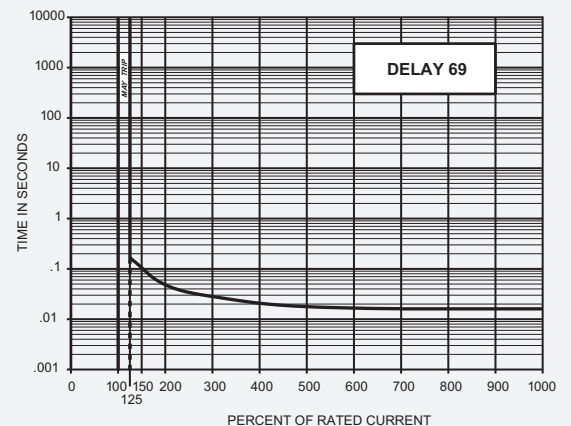
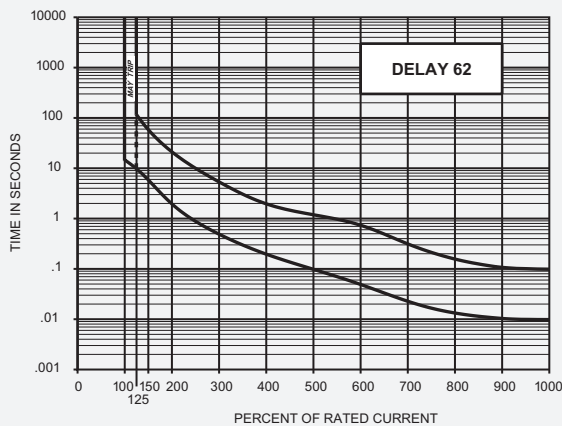
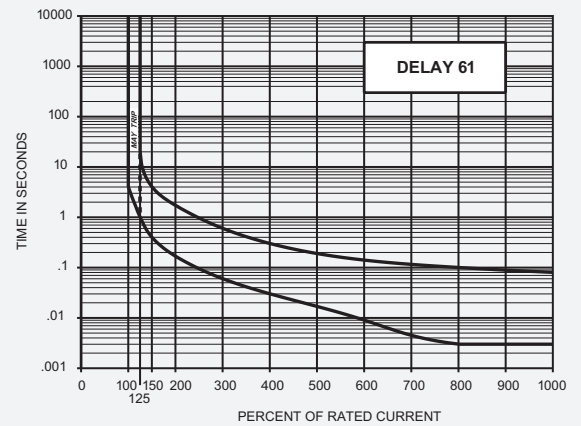
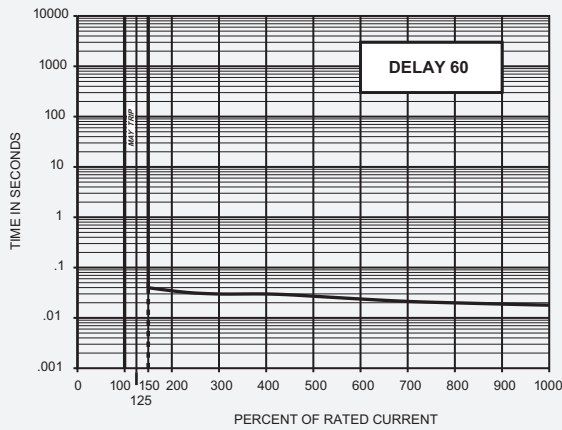

Delays 64, 65 and 66

Delays 64, 65 and 66 are the latest 50/60Hz delays with short, medium and long trip times respectively. The patented protector design provides both increased tolerance to high inrush induced nuisance tripping and longer trip times at 600 percent. These delays are ideally suited for applications where thermal devices are presently used, such as motor protection or where short duration, high inrush currents are experienced. As shown in a typical motor start-up curve, the delay 66 will provide locked rotor and overload protection. Nuisance tripping is avoided since acceptable short periods of overload will not trip the protector.

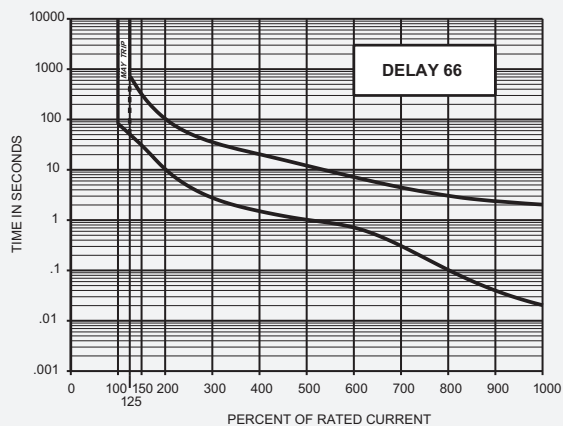
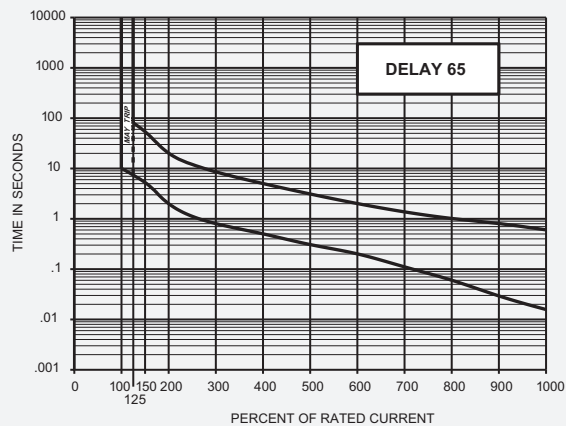
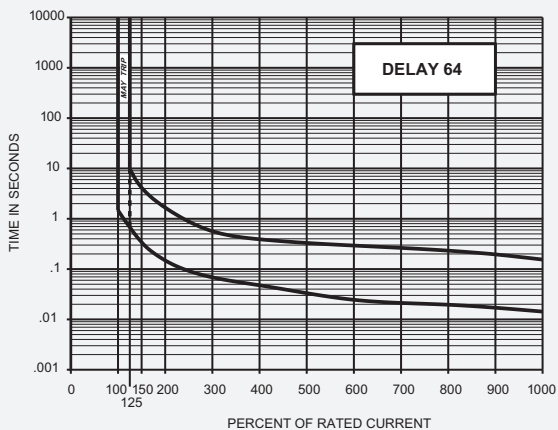

DC/50/60Hz Delay Curves (typ) (Multi-frequency)

A choice of delays is offered for combined DC and 50/60Hz operation. Delay 70 is fast acting, non-delayed tripping to protect sensitive electronic equipment (not recommended where known inrush exists). Delay 71 has a short delay for general purpose applications. Delay 72 is long enough to start certain types of motors and most transformer and capacitor loads. Delay 73 is an extra long delay primarily for special motor applications.

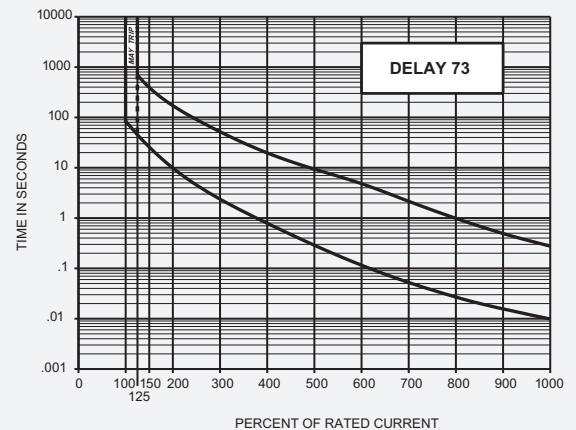
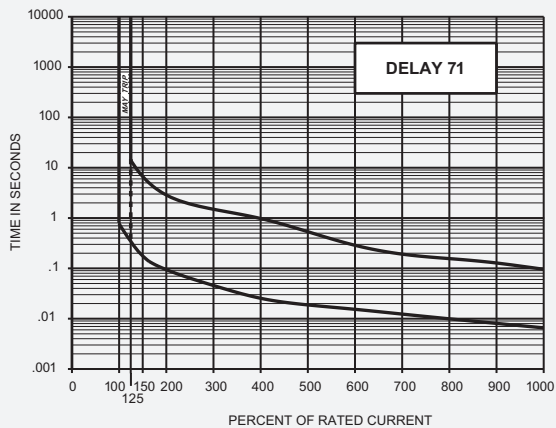
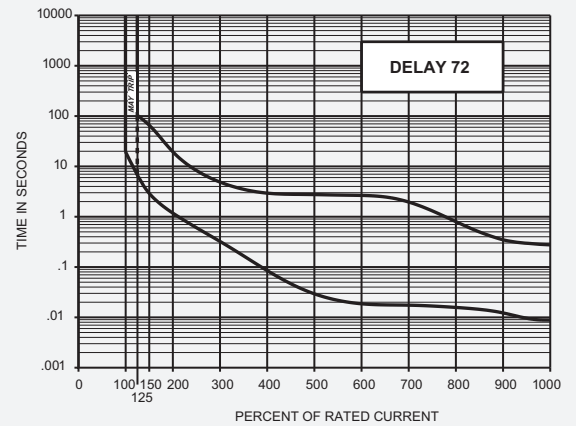
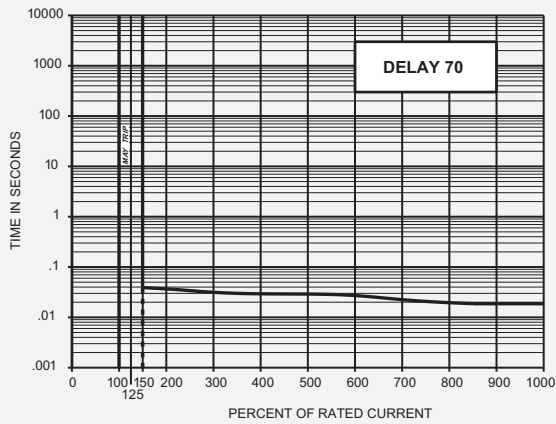

DC Delay Curves (typ)

A choice of delays is offered for DC applications. Delays 50 and 59 provide fast acting, non-delayed tripping to protect sensitive electronic equipment (not recommended where known inrush exists). Delay 51 has a short delay for general purpose applications. Delay 52 is long enough to start certain types of motors. Delay 53 is an extra long delay used primarily for special motor applications.

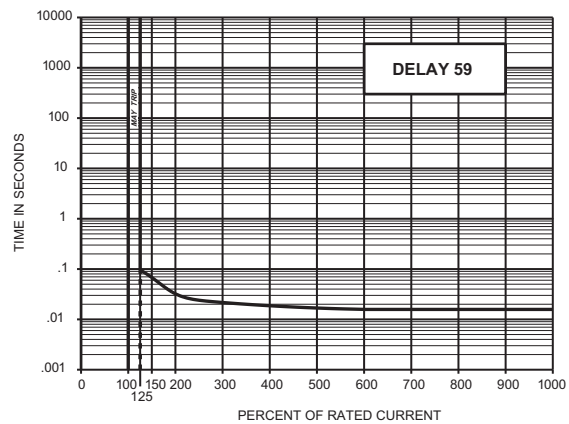
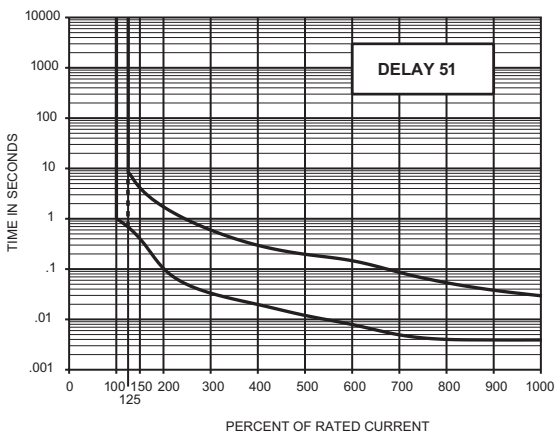
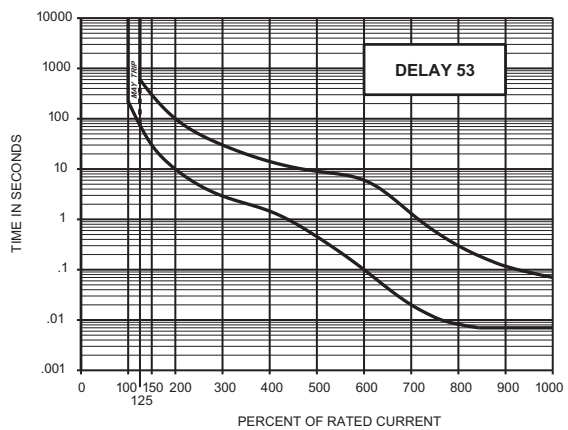
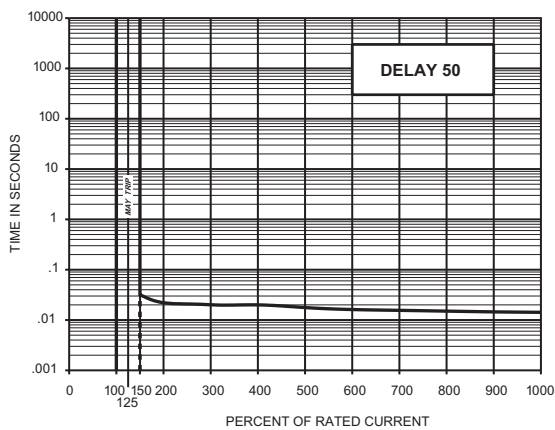
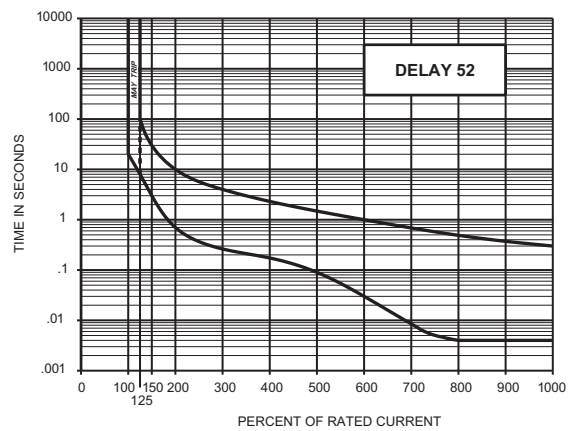

400Hz Delay Curves (typ)

A choice of delays is offered for 400Hz applications. Delays 40 and 49 are fast acting, non-delayed tripping to protect sensitive electronic equipment (not recommended where known inrush exists). Delay 41 has a short delay for general purpose applications. Delay 42 is long enough to start certain types of motor and most transformers and capacitor loads. Delay 43 is an extra long delay primarily for special motor applications.

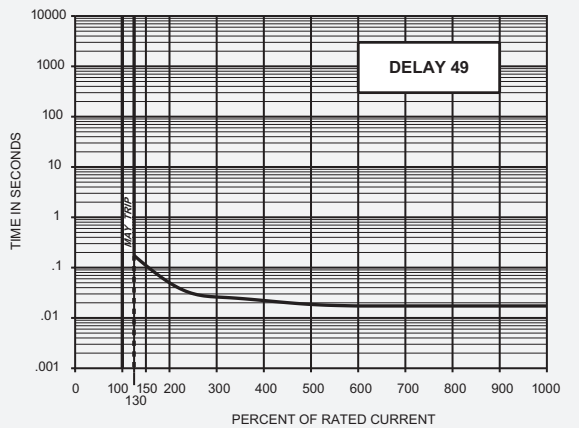
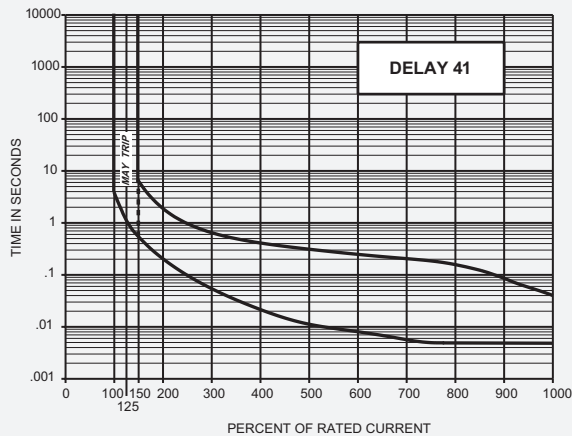
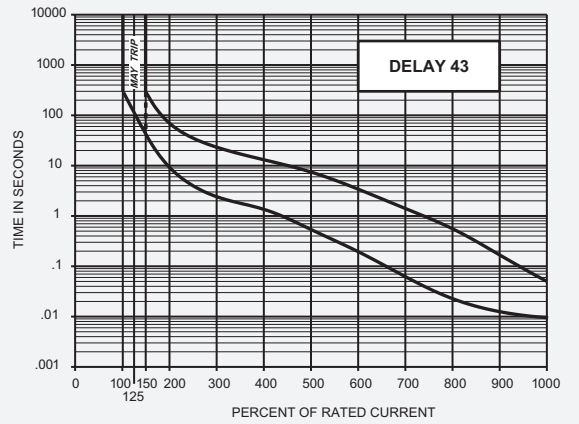
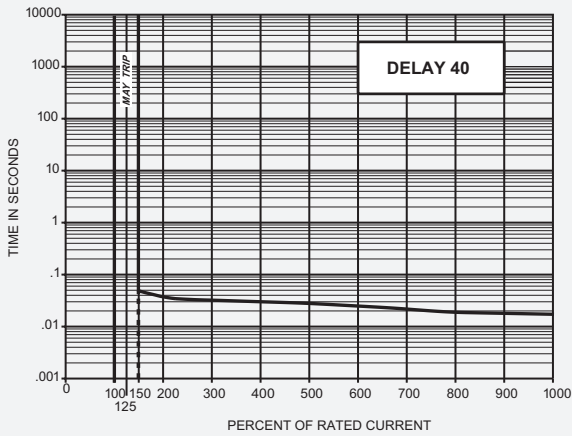
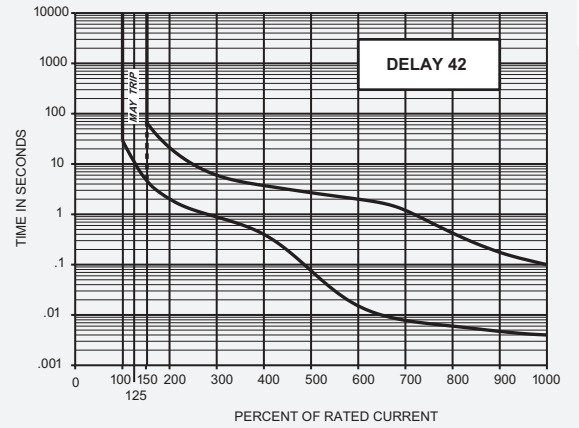

APL/UPL SPECIFICATIONS

Trip Free

Will trip open on overload, even when the handle is forcibly held on or restrained. This prevents operator from damaging the circuit by holding the handle in the ON position.

Trip Indication

The operating handle moves positively to the OFF position on overload.

Ambient Operation

Operates normally in temperatures between -40°C and $+85^{\circ}\text{C}$.

Insulation Resistance

Not less than 100 megohms at 500Vdc.

Dielectric Strength

Withstands 1500Vac at 60Hz for 60 seconds or 1800Vac for one second from terminal to terminal, and from auxiliary switch terminal to main terminal.

Endurance

Per UL 1077 (6000 operations at rated load plus 4000 operations with no load). Tested at a maximum rate of 6 times per minute. Rating above 50 amperes operate a minimum of 5000 operations.

Shock

Withstands 100G or more without tripping while carrying full rated current per MIL-Std-202, Method 213, Test Condition I. Instantaneous types (delay 40, 50, 60 and 49, 59, 69) and dual coil configurations are tested at 80% of rated current. Protectors mounted in the handle down position are to be tested with no current applied (per MIL-PRF-55629).

Vibration

Withstands 10G without tripping while carrying full rated current per MIL-Std-202, Method 204, Test Condition A. Instantaneous types (delay 40, 50, 60 and 49, 59, 69) and dual coil configurations are tested at 80% of rated current.

Dual Coil Ratings

5-65Vdc and 5-250Vac for three terminal configurations. 5-120Vac and 5-120Vdc for four terminal configurations. Not available in delays 64, 65 and 66.

APL Ratings

0.050-50 amperes, 65Vdc, 250Vac maximum, 50/60Hz or 400Hz. 51-100 amperes at 65Vdc and 120Vac maximum. Ratings of 0.050-20 amperes at 277Vac, 50/60Hz are available upon request.

Auxiliary Switch Ratings

REC4 and REC5 are rated at 10 amperes, 250Vac or 3 amperes, 50Vdc. REG4 and REG5 are rated at 0.1 amperes, 125Vac.

UPL Ratings

UPL protectors are UL STD. 1077 (File No. E-66410) and CSA STD. C22.2–No. 235 (File No. LR-26229) recognized as supplementary protectors in the following configurations and ratings. Consult factory for further information.

Configurations

Series, Shunt, Relay, Auxiliary Switch, Switch Only, Dual Coil, No Voltage.

Poles

One through nine.

Moisture Resistance

Designed to meet the requirements of MIL-PRF-55629 when tested in accordance with Method 106 of MIL-Std-202.

Salt Spray (Corrosion)

Designed to meet the requirements of MIL-PRF-55629 when tested in accordance with Method 101 of MIL-Std-202.

APPROXIMATE WEIGHT PER POLE

Ounces	Grams
3.7	103

RECOMMENDED TORQUE SPECIFICATIONS

Component	Torque (in-lbs)
6-32 Mounting Inserts	6 to 8
M3 Mounting Screws	4 to 5
10-32 Screw Terminals	13 to 14
M5 Stud Terminals	13 to 14
1/4 - 20 Stud Terminals	25 to 30

Where applicable, mechanical support must be provide to the terminals when applying torque

APL/UPL - NOMINAL DCR / IMPEDANCE

Current Ratings (Amps)	Resistance (ohms)				Impedance (ohms)				Impedance (ohms)	
	DC Delays				AC, 50/60Hz Delays				AC, 400Hz Delays	
	50	59	51, 52, 53	Dual Coil 51, 52, 53	60	69	600, 61, 62 71, 72, 73	64, 65, 66 Dual Coil 61, 62	40, 49	41, 42, 43
0.05	162	540	460	640	174	419	582	691	1975	1195
0.10	35.4	105	155	150	42.5	103.4	119.0	160	495	284
0.50	1.2	4.2	4.5	5.6	1.9	4	4.1	6.2	22	12
1.0	.236	1.02	1.2	1.41	.41	.955	1.08	1.56	5.01	2.72
5.0	.021	.048	.059	.070	.030	.045	.048	.068	.240	.140
10.0	.0060	.0121	.0140	.0160	.0075	.0105	.0134	.0174	.0520	.0283
15.0	.0040	.0067	.0092	.0100	.0038	.0068	.0070	.0120	.0260	.0140
20.0	.0032	.0047	.0052	.0070	.0024	.0049	.0050	.0069	.0140	.0088
30.0	.0021	.0036	.0036	.0040	.0022	.0032	.0035	.0037	.0079	.0043
50.0	.0020	.0024	.0026	.0023	.0020	.0020	.0025	.0030	.0036	.0028

Notes: DCR and impedance based on 100% rated current applied and stabilized a minimum of one hour.

Tolerance: .02 amperes to 2.5 amperes, $\pm 20\%$; 2.6 amperes to 20 amperes, $\pm 25\%$; 21 amperes to 50 amperes, $\pm 50\%$. Consult factory for special values and for coil impedance of delays not shown

APL/UPL - RATINGS

Configurations	Current Ratings (Amps)	Maximum Voltage Ratings	Interrupting Capacity (Amps)	Series Fuse
Series and Shunt	0.050 - 50	65Vdc	5000	None
	0.050 - 100	65Vdc	3000	None
	0.050 - 60	120Vac (50/60Hz)	1000	None
	0.050 - 50	120Vac (50/60Hz)	5000	4X (120 max.)
	0.050 - 20	277Vac (50/60Hz)	5000	4X
	0.050 - 50	250Vac (50/60Hz)	5000	4X (120 max.)
	0.050 - 50	120Vac (400Hz)	1500	None
	21 - 50	250Vac (400Hz)	1000	None
	0.050 - 20	250Vac (400Hz)	2100	None
Relay	0.050 - 50	50Vdc	—	—
	0.050 - 50	120Vac (50/60Hz)	—	—
	0.050 - 50	120Vac (400Hz)	—	—
	0.050 - 50	250Vac (50/60Hz-400Hz)	—	—
Switch Only	50 amperes max. 65Vdc	—	—	—
	100 amperes max. 32Vdc	—	—	—
	50 amperes max. 250Vac (50/60Hz)	—	—	—
	50 amperes max. 250Vac (400Hz)	—	—	—

Notes: DC units do not require series fusing.

277Vac: A circuit protector with this voltage rating is intended for 277Vac per pole single phase source only usage. (e.g.) If a two or three pole breaker is marked 277Vac, all line terminals must be connected to the same phase, assuming the 277Vac is taken from line to neutral of a three phase 277/480Vac system.

MPL SPECIFICATIONS

Moisture Resistance

Designed to meet the requirements of MIL-PRF-55629 when tested in accordance with Method 106 of MIL-Std-202.

Salt Spray (Corrosion)

Designed to meet the requirements of MIL-PRF-55629 when tested in accordance with Method 101 of MIL-Std-202.

MPL Ratings

MPL protectors are UL (File No. E-41607) and CSA (File No. LR-26229) recognized as manual, across the line starters, in the following configurations and ratings. Consult factory for further information.

Configurations

Series only with and without auxiliary switch.

Poles

One, two or three.

Shock

Withstands 100G or more without tripping while carrying full rated current per MIL-Std-202, Method 213, Test Condition I. Instantaneous types (delay 40, 50, 60 and 49, 59, 69) are tested at 80% of rated current. Breakers mounted in the handle down position are to be tested with no current applied (per MIL-PRF-55629).

Vibration

Withstands 10G without tripping while carrying full rated current per MIL-Std-202, Method 204, Test Condition A. Instantaneous types (delay 40, 50, 60 and 49, 59, 69) are tested at 80% of rated current.

RECOMMENDED TORQUE SPECIFICATIONS	
Component	Torque (in-lbs)
6-32 Mounting Inserts	6 to 8
M3 Mounting Screws	4 to 5
10-32 Screw Terminals	13 to 14
M5 Stud Terminals	13 to 14
1/4 - 20 Stud Terminals	25 to 30

Where applicable, mechanical support must be provide to the terminals when applying torque

APPROXIMATE WEIGHT PER POLE	
Ounces	Grams
3.7	103

MPL - RATINGS			
Current Ratings (Amps)	Maximum Voltage Ratings	Horsepower, Single Phase	Ratings Three Phase (Note A)
0.050 - 50	65Vdc	1	—
0.050 - 50	120Vac (50/60Hz)	3	7.5
0.050 - 20	240Vac (50/60Hz)	3	5
0.050 - 20	277Vac (50/60Hz)	3	5

Note: AC units require maximum of 4X rated series fusing: DC units do not require series fusing.
A: Two or three poles breaking

APL/UPL DECISION TABLES

How to Order

The ordering code for APL/UPL circuit protectors may be determined by following the steps in the decision tables shown here.

The coding given permits a self-assigning part number; other configurations may require a factory assigned part number. Typical examples are units with mixed ratings, combinations of styles or constructions not listed in the third decision table, etc.

With these, it is suggested that order entry be by description and/or drawings and a part number will be assigned. Additionally, it is a standard policy to establish a factory assigned part number wherever a descriptive drawing exists to provide cross reference, traceability and manufacturing control.

When specifying a protector for AC motor start or high inrush applications, the peak amplitude and surge duration should be specified for factory assistance in rating selection.

For example, the code shown is the code for a two pole UPL protector with series trip, 20 ampere rating, 50/60Hz. short time delay construction in all poles.

To determine the ordering number for your particular APL/UPL unit, simply follow the steps shown. You may use this number to place an order or as a reference for further questions you may have.

Notes:

- A The most common current values for 100% of rated current are those listed. Please consult an Airpax office or sales representative for other values.
- B All APL/UPL protectors are constructed with stainless steel springs and plated parts. As noted in the specifications, all meet normal requirements for moisture and salt spray resistance. If fungus resistance is required in addition to moisture and salt spray resistance, special procedures and markings are employed.
- C Terminals will be supplied as #10-32 threaded studs up to 50 amperes. Above this amperage terminals will be ¼-28 threaded studs. All standard units will be supplied with a hex nut and two flat washers on each threaded terminal.
- D When metric threaded inserts are specified, breakers rated at 50 amperes and below will be supplied with metric threaded terminals. For breakers rated above 50 amperes, ¼ -28 threaded terminals will be supplied.
- E Black handle standard.

Example:

UPL 11 - 1 - 61 - 20 3

1 2 3 4 5

1 First Decision	
Type	
APL	Magnetic circuit protector in a molded phenolic case
UPL	UL and CSA recognized as a supplementary protector
MPL	UL and CSA recognized as a "manual across the line starter"

2 Second Decision	
Poles	
0*	Switch only
1	Single pole unit
11	Two pole unit
111	Three pole unit
1111	Four pole unit

*Use 0 in place of 1 when ordering switch only.

3 Third Decision	
Internal Configuration	
-0	Switch only (omit 4th and 5th decisions)
-1	Series
-1REC4	Series with auxiliary switch *.110 quick connect terminals
-1REC5	Series with auxiliary switch *.187 quick connect terminals
-1REG4	Series with auxiliary switch (gold contacts) *.110 quick connect terminals
-1RS	Series with alarm switch electrical trip turret terminals
-3	Shunt
-5	Relay

Multi-pole units with mixed construction, poles numbered left to right when viewed from terminal end.
*Can be used for Solder Terminals also.

4 Fourth Decision	
Hz and Delay	
40*	400Hz 150% instant trip
41*	400Hz short delay
42*	400Hz long delay
43*	400Hz motor start
49*	400Hz 130% instant trip
50	DC 150% instant trip
51	DC short delay
52	DC long delay
53*	DC motor start
59	DC 125% instant trip
60	50/60Hz 150% instant trip
61	50/60Hz short delay
62	50/60Hz long delay
64	50/60Hz short delay (high pulse)
65	50/60Hz long delay (high pulse)
66*	50/60Hz motor start (high pulse)
69	50/60Hz 125% instant trip
70*	DC-50/60Hz 150% instant trip
71*	DC-50/60Hz short delay
72*	DC-50/60Hz long delay
73*	DC-50/60Hz motor start delay

For addition of inertial delay, add an "F" to any delay number, except 40, 50, 60 and 70.
*Not available above 50 amperes.

5 Fifth Decision (Note A)	
Nominal Amperage Rating	
Current Code	Ratings (Amps)
101	.100
251	.250
501	.500
751	.750
102	1.00
252	2.50
502	5.0
752	7.50
103	10.0
153	15.0
203	20.0
303	30.0
353	35.0
403	40.0
503	*50.0
603	60.0
703	70.0
803	80.0
903	90.0
104	*100.0

Standard current ratings listed. For other ratings, please consult the factory.
*Switch only ratings.

6 Sixth Decision	
Optional	
A	Metric thread mounting inserts and terminals (Note D)
B	Barrier (multi-pole only)
C	277Vac 50/60Hz
M	Fungus (note B)
H	International handle markings
9	White handle (note E)

Looking for pricing, stock, or lifecycle information?

Click below to explore more details on WIN SOURCE:

 [View APL111R-559-490 on WIN SOURCE](#)

 [Sensata-Airpax Information](#)

Optimize Your Supply Chain with WIN SOURCE Solutions

-  Global Sourcing Solution
-  Obsolete Management
-  Cost Control Management
-  Shortage Management
-  Alternative Solution
-  Excess Inventory Management