



**THE DATASHEET OF
AOK160A60**



General Description

- Proprietary aMOS5™ technology
- Low $R_{DS(ON)}$
- Optimized switching parameters for better EMI performance
- Enhanced body diode for robustness and fast reverse recovery

Applications

- SMPS with PFC, Flyback and LLC topologies
- Micro inverter with DC/AC inverter topology

Product Summary

$V_{DS} @ T_{j,max}$	700V
I_{DM}	96A
$R_{DS(ON),max}$	< 0.16Ω
$Q_{g,typ}$	46nC
$E_{oss} @ 400V$	4.9μJ

100% UIS Tested
 100% R_g Tested

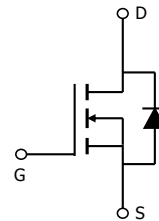
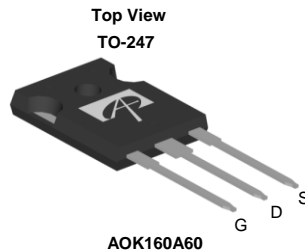

Orderable Part Number	Package Type	Form	Minimum Order Quantity
AOK160A60	TO247	Tube	240

Absolute Maximum Ratings $T_A=25^\circ\text{C}$ unless otherwise noted

Parameter	Symbol	Maximum	Units
Drain-Source Voltage	V_{DS}	600	V
Gate-Source Voltage	V_{GS}	±20	V
Gate-Source Voltage (dynamic) AC($f>1\text{Hz}$)	V_{GS}	±30	V
Continuous Drain Current	I_D	$T_C=25^\circ\text{C}$	24
		$T_C=100^\circ\text{C}$	15
Pulsed Drain Current ^C	I_{DM}	96	A
Avalanche Current ^C	I_{AR}	6	A
Repetitive avalanche energy ^C	E_{AR}	18	mJ
Single pulsed avalanche energy ^G	E_{AS}	172	mJ
MOSFET dv/dt ruggedness	dv/dt	100	V/ns
Peak diode recovery dv/dt		20	
Power Dissipation ^B	P_D	$T_C=25^\circ\text{C}$	250
		Derate above 25°C	2.0
Junction and Storage Temperature Range	T_J, T_{STG}	-55 to 150	°C
Maximum lead temperature for soldering purpose, 1/8" from case for 5 seconds	T_L	300	°C

Thermal Characteristics

Parameter	Symbol	Maximum	Units
Maximum Junction-to-Ambient ^{A,D}	$R_{\theta JA}$	40	°C/W
Maximum Case-to-sink ^A	$R_{\theta CS}$	0.5	°C/W
Maximum Junction-to-Case	$R_{\theta JC}$	0.5	°C/W

Electrical Characteristics (T_J=25°C unless otherwise noted)

Symbol	Parameter	Conditions	Min	Typ	Max	Units	
STATIC PARAMETERS							
BV _{DSS}	Drain-Source Breakdown Voltage	I _D =250μA, V _{GS} =0V, T _J =25°C	600			V	
		I _D =250μA, V _{GS} =0V, T _J =150°C		700			
BV _{DSS} /ΔT _J	Breakdown Voltage Temperature Coefficient	I _D =250μA, V _{GS} =0V		0.53		V/°C	
I _{DSS}	Zero Gate Voltage Drain Current	V _{DS} =600V, V _{GS} =0V			1	μA	
		V _{DS} =480V, T _J =125°C			10		
I _{GSS}	Gate-Body leakage current	V _{DS} =0V, V _{GS} =±20V			±100	nA	
V _{GS(th)}	Gate Threshold Voltage	V _{DS} =5V, I _D =250μA	2.4	3	3.6	V	
R _{DS(on)}	Static Drain-Source On-Resistance	V _{GS} =10V, I _D =12A		0.14	0.16	Ω	
g _{FS}	Forward Transconductance	V _{DS} =10V, I _D =12A		20		S	
V _{SD}	Diode Forward Voltage	I _S =12A, V _{GS} =0V		0.87	1.2	V	
I _S	Maximum Body-Diode Continuous Current				24	A	
I _{SM}	Maximum Body-Diode Pulsed Current ^C				96	A	
DYNAMIC PARAMETERS							
C _{iss}	Input Capacitance	V _{GS} =0V, V _{DS} =100V, f=1MHz		2340		pF	
C _{oss}	Output Capacitance				62		pF
C _{o(er)}	Effective output capacitance, energy related ^H	V _{GS} =0V, V _{DS} =0 to 480V, f=1MHz		56		pF	
C _{o(tr)}	Effective output capacitance, time related ^I				233		pF
C _{rss}	Reverse Transfer Capacitance	V _{GS} =0V, V _{DS} =100V, f=1MHz		1.3		pF	
R _g	Gate resistance	f=1MHz		5.4		Ω	
SWITCHING PARAMETERS							
Q _g	Total Gate Charge	V _{GS} =10V, V _{DS} =480V, I _D =12A		46		nC	
Q _{gs}	Gate Source Charge				17		nC
Q _{gd}	Gate Drain Charge				14		nC
t _{D(on)}	Turn-On DelayTime	V _{GS} =10V, V _{DS} =400V, I _D =12A, R _G =5Ω		34		ns	
t _r	Turn-On Rise Time				29		ns
t _{D(off)}	Turn-Off DelayTime				63		ns
t _f	Turn-Off Fall Time				19		ns
t _{rr}	Body Diode Reverse Recovery Time	I _F =12A, di/dt=100A/μs, V _{DS} =400V		387		ns	
I _{rm}	Peak Reverse Recovery Current				30		A
Q _{rr}	Body Diode Reverse Recovery Charge				7.3		μC

A. The value of R_{θJA} is measured with the device in a still air environment with T_A=25° C.

B. The power dissipation P_D is based on T_{J(MAX)}=150° C, using junction-to-case thermal resistance, and is more useful in setting the upper dissipation limit for cases where additional heatsinking is used.

C. Repetitive rating, pulse width limited by junction temperature T_{J(MAX)}=150° C, Ratings are based on low frequency and duty cycles to keep initial T_J=25° C.

D. The R_{θJA} is the sum of the thermal impedance from junction to case R_{θJC} and case to ambient.

E. The static characteristics in Figures 1 to 6 are obtained using <300μs pulses, duty cycle 0.5% max.

F. These curves are based on the junction-to-case thermal impedance which is measured with the device mounted to a large heatsink, assuming a maximum junction temperature of T_{J(MAX)}=150° C. The SOA curve provides a single pulse rating.

G. L=60mH, I_{AS}=2.4A, R_G=25Ω, Starting T_J=25° C.

H. C_{o(er)} is a fixed capacitance that gives the same stored energy as C_{oss} while V_{DS} is rising from 0 to 80% V_{(BR)DSS}.

I. C_{o(tr)} is a fixed capacitance that gives the same charging time as C_{oss} while V_{DS} is rising from 0 to 80% V_{(BR)DSS}.

APPLICATIONS OR USES AS CRITICAL COMPONENTS IN LIFE SUPPORT DEVICES OR SYSTEMS ARE NOT AUTHORIZED. AOS DOES NOT ASSUME ANY LIABILITY ARISING OUT OF SUCH APPLICATIONS OR USES OF ITS PRODUCTS. AOS RESERVES THE RIGHT TO MAKE CHANGES TO PRODUCT SPECIFICATIONS WITHOUT NOTICE. IT IS THE RESPONSIBILITY OF THE CUSTOMER TO EVALUATE SUITABILITY OF THE PRODUCT FOR THEIR INTENDED APPLICATION. CUSTOMER SHALL COMPLY WITH APPLICABLE LEGAL REQUIREMENTS, INCLUDING ALL APPLICABLE EXPORT CONTROL RULES, REGULATIONS AND LIMITATIONS.

AOS' products are provided subject to AOS' terms and conditions of sale which are set forth at:

http://www.aosmd.com/terms_and_conditions_of_sale

TYPICAL ELECTRICAL AND THERMAL CHARACTERISTICS

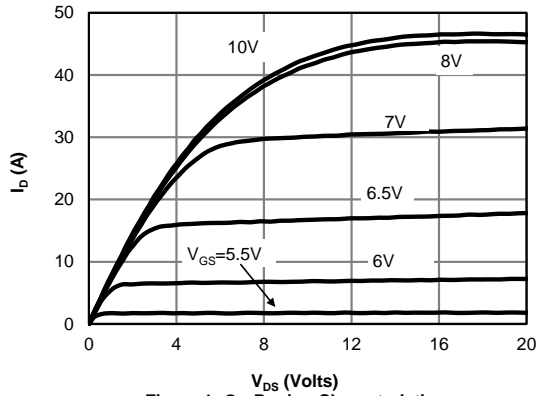

Figure 1: On-Region Characteristics

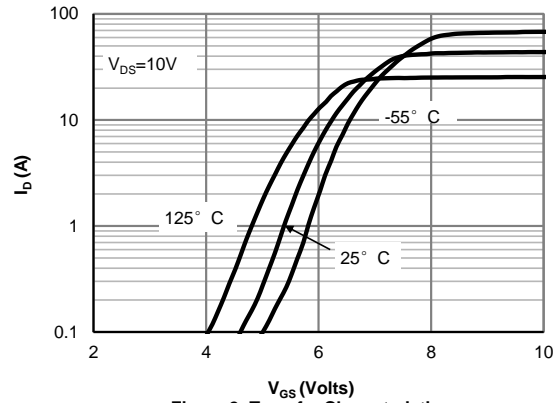

Figure 2: Transfer Characteristics

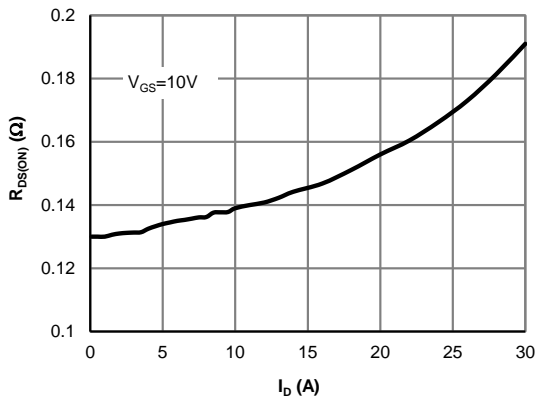

Figure 3: On-Resistance vs. Drain Current and Gate Voltage

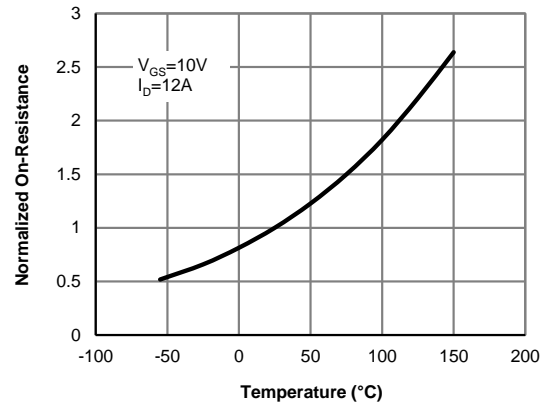

Figure 4: On-Resistance vs. Junction Temperature

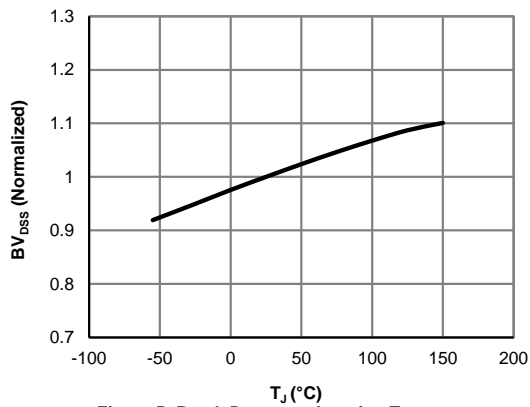

Figure 5: Break Down vs. Junction Temperature

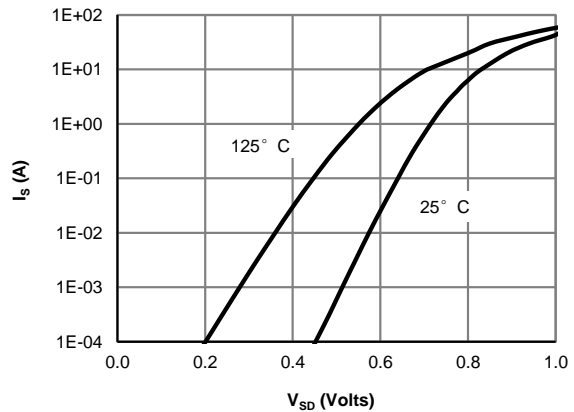

Figure 6: Body-Diode Characteristics

TYPICAL ELECTRICAL AND THERMAL CHARACTERISTICS

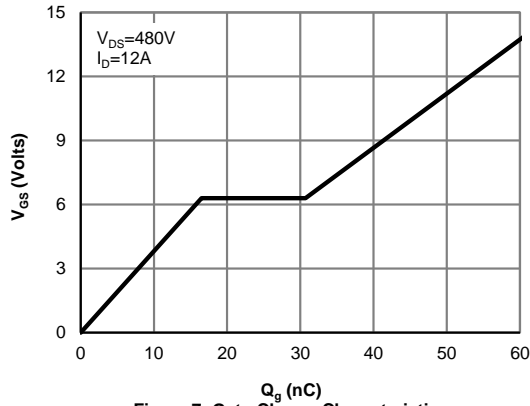

Figure 7: Gate-Charge Characteristics

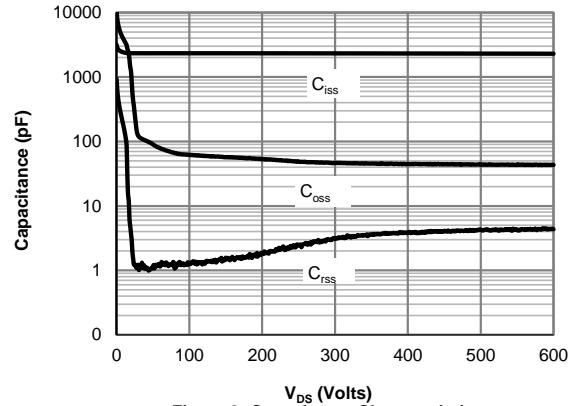

Figure 8: Capacitance Characteristics

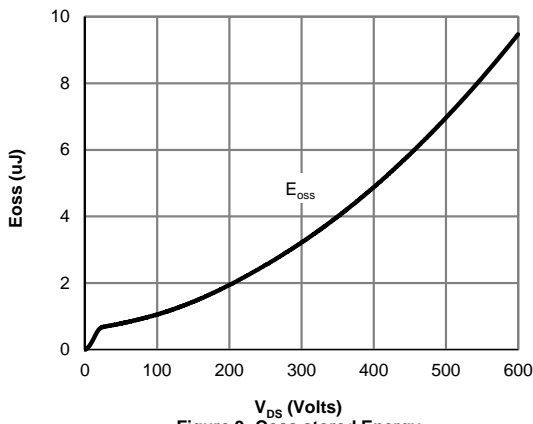

Figure 9: Coss stored Energy

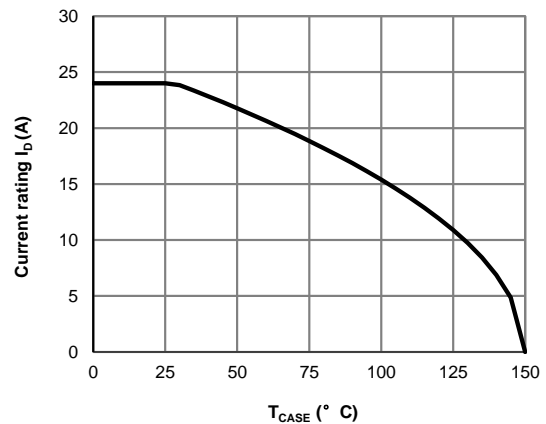

Figure 10: Current De-rating (Note F)

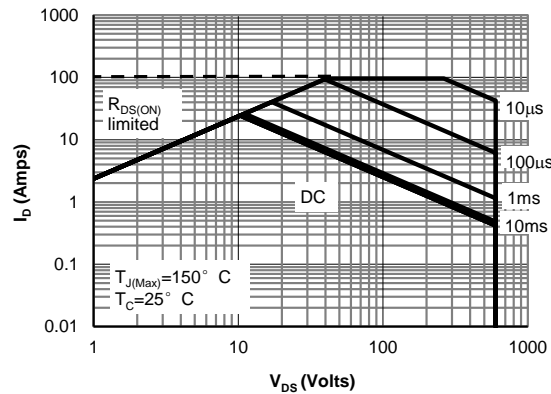

Figure 11: Maximum Forward Biased Safe Operating Area (Note F)

TYPICAL ELECTRICAL AND THERMAL CHARACTERISTICS

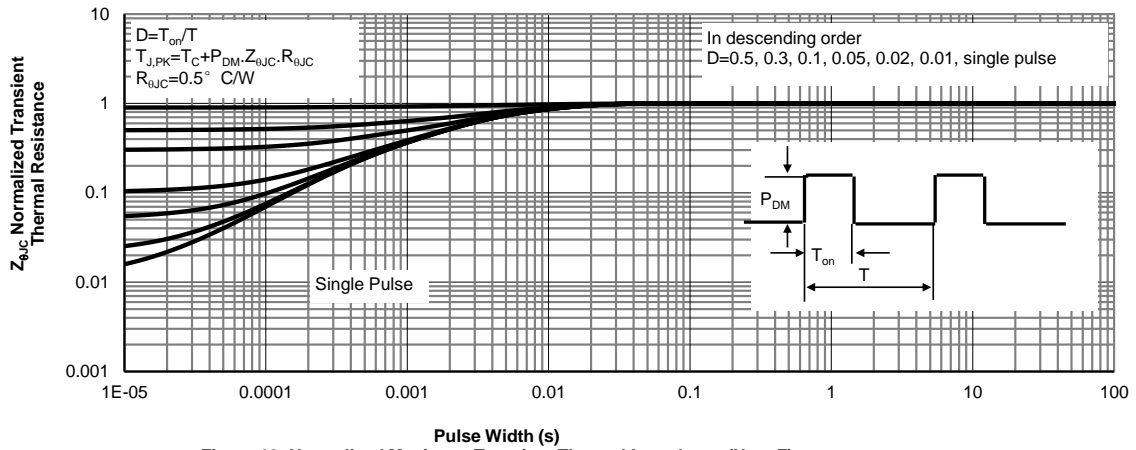
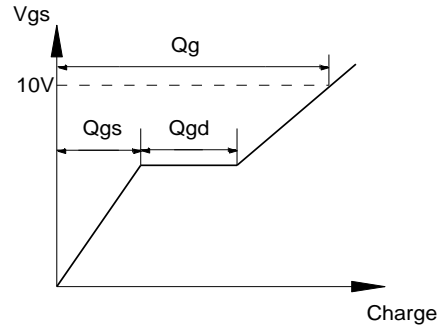
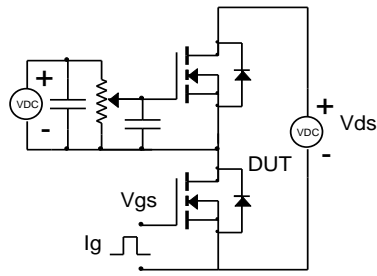
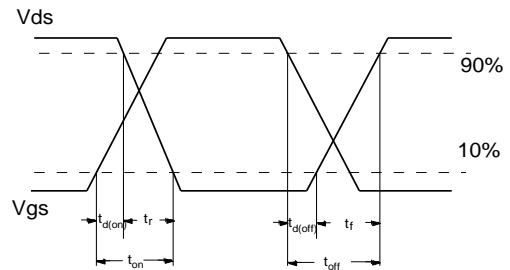
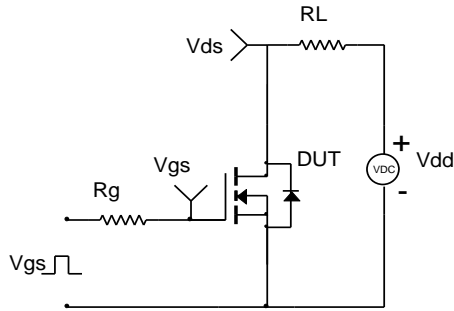

Figure 12: Normalized Maximum Transient Thermal Impedance (Note F)

Gate Charge Test Circuit & Waveform



Resistive Switching Test Circuit & Waveforms



Unclamped Inductive Switching (UIS) Test Circuit & Waveforms

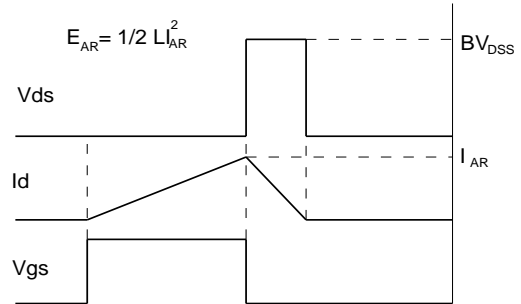
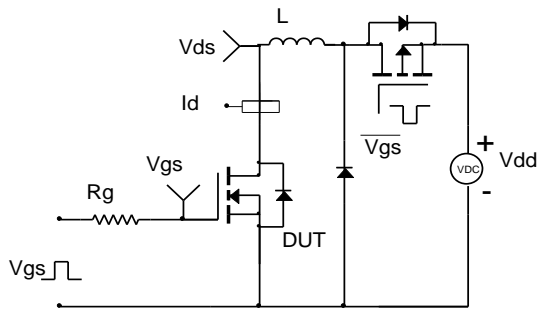

Diode Recovery Test Circuit & Waveforms

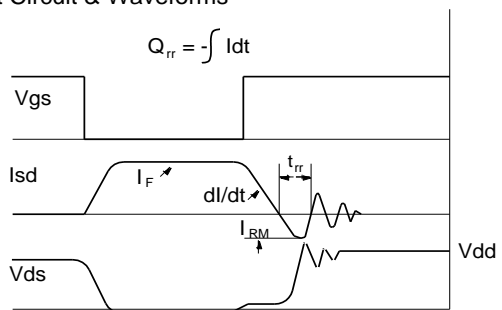
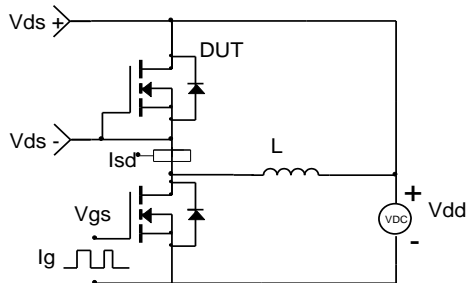

Looking for pricing, stock, or lifecycle information?

Click below to explore more details on WIN SOURCE:

- [View AOK160A60 on WIN SOURCE](#)
- [Alpha & Omega Semiconductor Inc. Information](#)

Optimize Your Supply Chain with WIN SOURCE Solutions

- ✓ Global Sourcing Solution
- ✓ Obsolete Management
- ✓ Cost Control Management
- ✓ Shortage Management
- ✓ Alternative Solution
- ✓ Excess Inventory Management