



**THE DATASHEET OF  
AOCJY7TQ-X-100.000MHZ-1**



# Ultra-Low Phase Noise OCXO

AOCJY7TQ

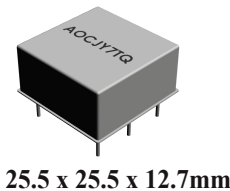

25.5 x 25.5 x 12.7mm

## FEATURES:

- Exceptional Close to the carrier Maximum Phase Noise of -155dBc/Hz @ 1kHz & -170dBc/Hz @ 10kHz offset from 100.0 MHz Carrier
- SC-Cut, High “Q” resonator based design
- 100.0MHz carrier frequency
- Excellent Frequency Stability of  $\pm 50.0$  ppb over the operating temperature range of  $-40^{\circ}\text{C}$  to  $+70^{\circ}\text{C}$
- Tuned Sinewave output into a  $50\Omega$  load
- Industry Standard, 25.5 x 25.5 x 12.7mm RoHS compliant & Pb free package

## APPLICATIONS:

- COTS Military & Industrial Radios & Timing Circuits
- Cellular Infrastructure
- Radar Systems
- Test & Measurement Equipment
- GPS Tracking with precision hold-over accuracy
- WiMax / WLAN
- Precision primary frequency reference clocks

## STANDARD SPECIFICATIONS:

### Maximum Rating

Parameters	Rating
Storage Temperature Range	$-55$ to $+125^{\circ}\text{C}$
Supply Voltage	$-0.3$ to $15\text{V}$
Control Voltage	$0$ to $5\text{V}$
ESD, HBM/CDM/MM	$2\text{kV}/1\text{kV}/200\text{V}$

Parameters	Minimum	Typical	Maximum	Units	Notes
Frequency (Fc)		100.000		MHz	
Initial Frequency Tolerance (@ $+25^{\circ}\text{C}$ ) at shipping			$\pm 300$	ppb	
Warm-up Time (@ $+25^{\circ}\text{C}$ )			5	minutes	with accuracy of $\pm 100$ ppb
<b>Frequency Stability Options (Ref. to Frequency @<math>+25^{\circ}\text{C}</math>)</b>					
$-40^{\circ}\text{C}$ to $+70^{\circ}\text{C}$			$\pm 50$	ppb	Option “5”
$-40^{\circ}\text{C}$ to $+70^{\circ}\text{C}$			$\pm 100$	ppb	Option “1”
$-40^{\circ}\text{C}$ to $+85^{\circ}\text{C}$			$\pm 200$	ppb	Option “2”
Frequency Stability vs. Supply Voltage Change ( $V_{\text{dd}}\pm 5\%$ )			$\pm 10$	ppb	
Frequency Stability vs. Load Change (Load $\pm 5\%$ )			$\pm 10$	ppb	
Aging per Day (after 30 days of operation)			$\pm 5$	ppb	
Aging per Year (after 30 days of operation)			$\pm 500$	ppb	
Supply Voltage ( $V_{\text{dd}}$ )	$+11.4$	$+12.0$	$+12.6$	V	
Power Consumption	During Warming-up		4.5	W	
	Steady@ $+25^{\circ}\text{C}$ & still air		1.5	W	
<b>Control Port ( Applicable for Voltage Controlled version only)</b>					
Control Voltage Range ( $V_{\text{c}}$ )	$+0$	$+2.5$	$+5$	V	
Center Control Voltage ( $V_{\text{c}}$ )		$+2.5$		V	To be with-in $\pm 300$ ppb of Fc @ $25^{\circ}\text{C}$
Frequency Tuning Range		$\pm 1000$		ppb	
Tuning Slope		Positive			
Linearity			$\pm 10$	%	
Port Impedance	50			$\text{k}\Omega$	

# Ultra-Low Phase Noise OCXO

AOCJY7TQ



25.5 x 25.5 x 12.7mm

## STANDARD SPECIFICATIONS:

(Continued)

Parameters	Minimum	Typical	Maximum	Unites	Notes
Phase Noise* (100MHz carrier frequency @25°C):		<-95	-93	dBc/Hz	Offset @10Hz
		<-126	-125		Offset @100Hz
		<-161	-155		Offset @1kHz
		-171	-170		Offset @10kHz
		-173	-170		Offset @100kHz
		-174	-170		Offset @1MHz
		-173	-170		Offset @10MHz
		-174	-170		Offset @20MHz
RMS Jitter (12kHz to 20MHz)		20	40	fs	
<b>Sine Wave Output</b>					
Output Level	8			dBm	
Harmonics			-30	dBc	
Spurious			-70	dBc	
Load		50		Ω	

\* Close to carrier phase noise is a few dB better in fixed clock configuration than the voltage controlled configuration

## PART IDENTIFICATION:

AOCJY7TQ -  - 100.000MHz -

Fixed Clock or Voltage Controlled
X = Fixed Clock
V = Voltage Controlled

Freq. Stability over Operating Temp.
5: ±50ppb
1: ±100ppb
2: ±200ppb



25.5 x 25.5 x 12.7mm

## TYPICAL FREQUENCY STABILITY VS. TEMPERATURE

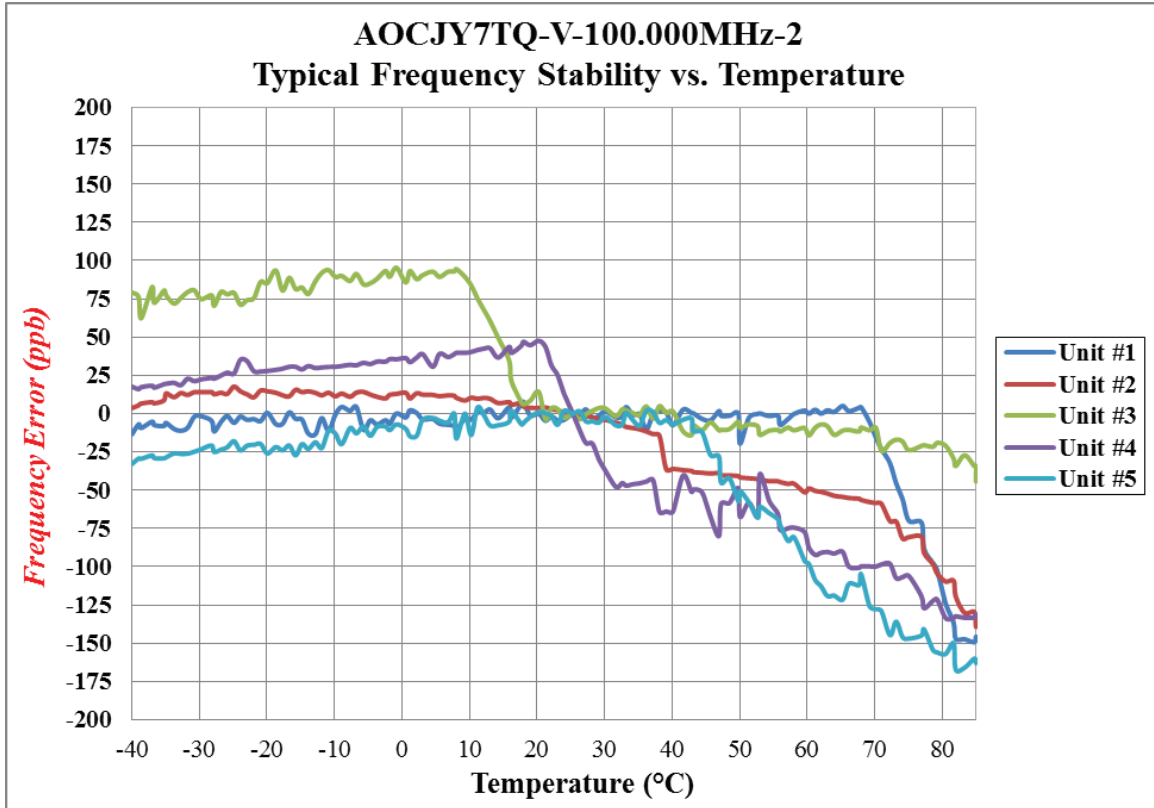

## TYPICAL SHORT TERM STABILITY

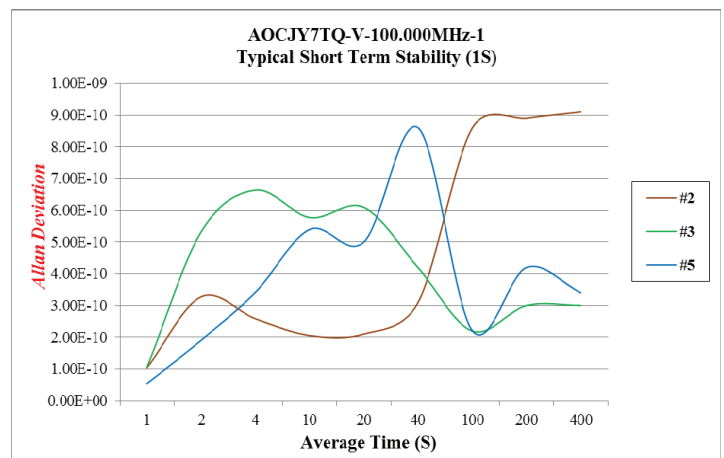
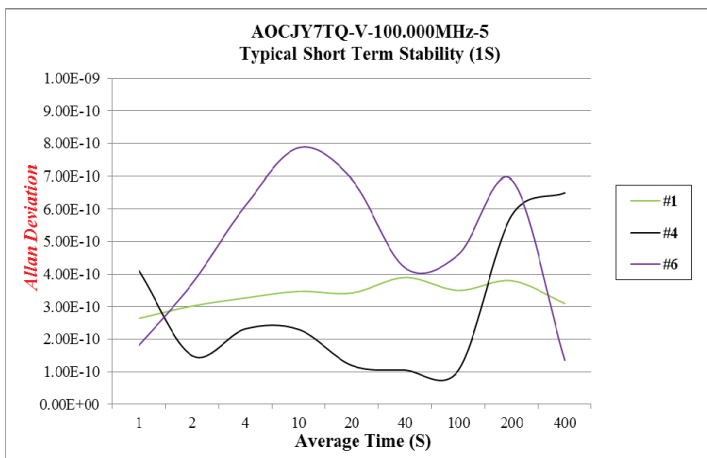

# Ultra-Low Phase Noise OCXO



25.5 x 25.5 x 12.7mm

AOCJY7TQ



## TYPICAL FREQUENCY PULL VS. CONTROL VOLTAGE

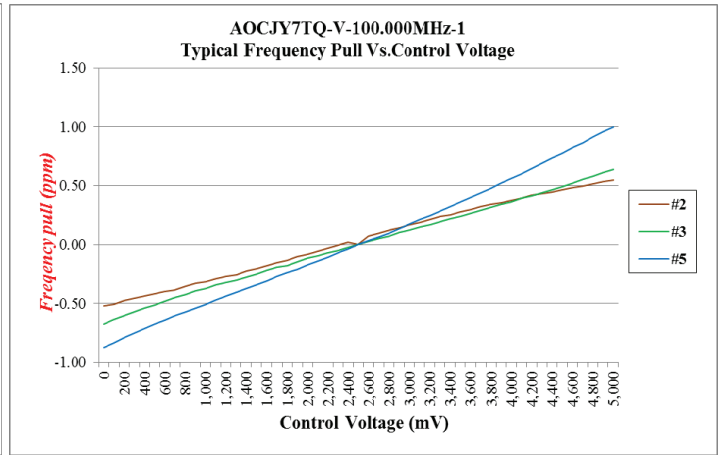
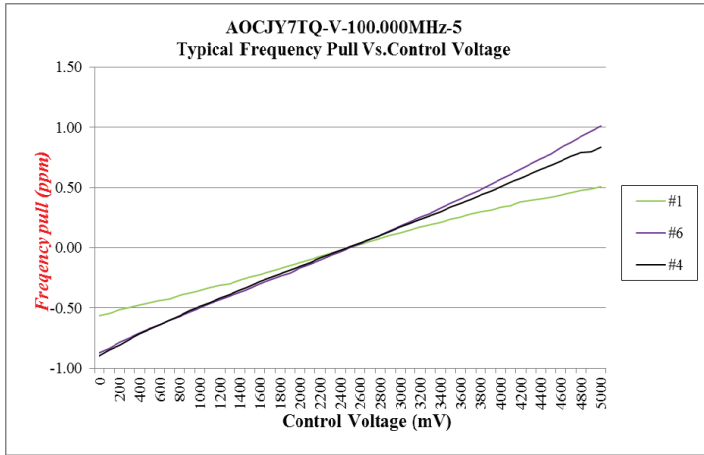

## TYPICAL PHASE NOISE

### 100.00 MHz Carrier

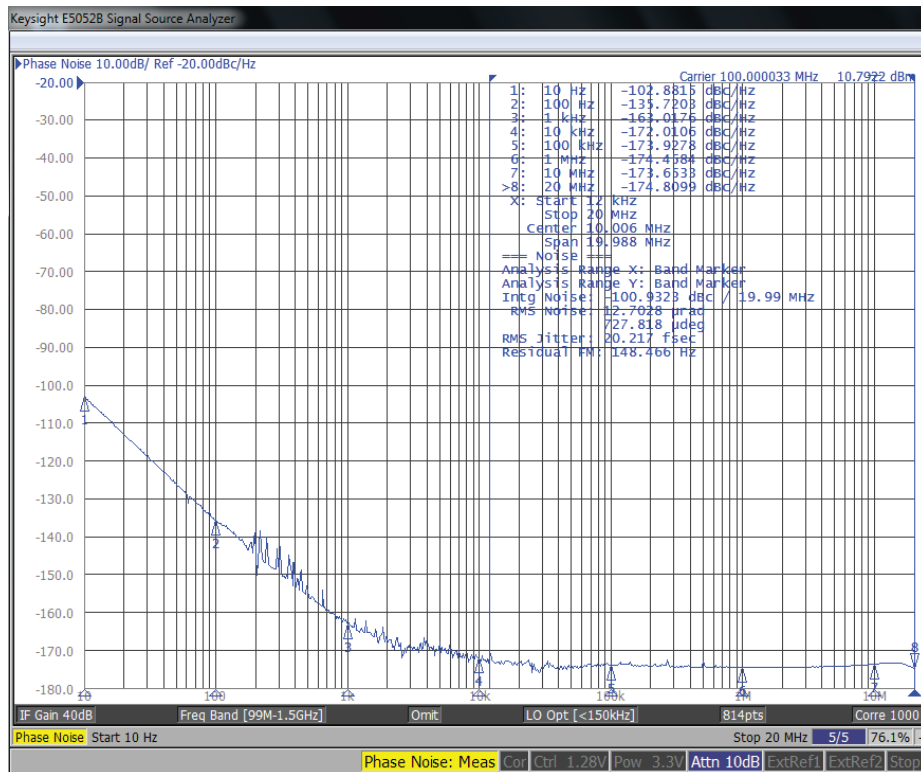

ABRACON IS  
ISO9001:2008  
CERTIFIED



2 Faraday, Suite# B | Irvine | CA 92618 Revised: 07.21.15  
Ph. 949.546.8000 | Fax. 949.546.8001  
Visit [www.abracon.com](http://www.abracon.com) for Terms and Conditions of Sale

# Ultra-Low Phase Noise OCXO

AOCJY7TQ



25.5 x 25.5 x 12.7mm

## OUTLINE DIMENSION:

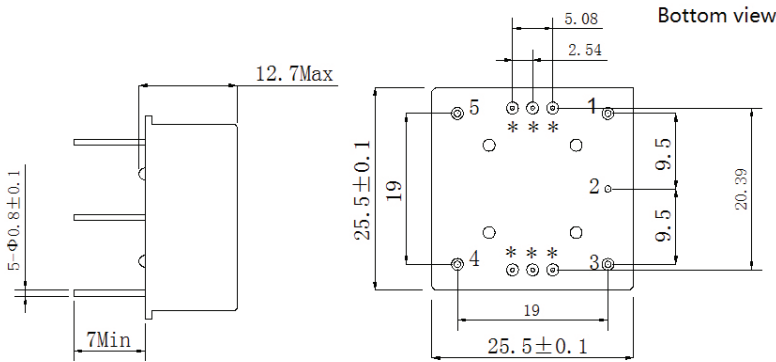

## Reference Connection of Voltage Control Circuit

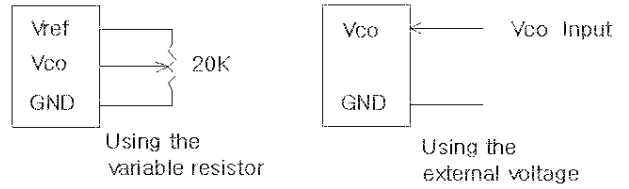

Pin	Function
1	RF Output
2	GND, Case
3	Vc (see Note 2 below)
4	Vref (See Note 3 below)
5	Vdd

### Notes:

1. The pins with "\*" are for factory testing purpose.
2. Please leave pin 3 not connected if Vc is not used.
3. Please leave pin 4 not connected if Vref is not used.

Dimensions: mm

## TAPE & REEL:

### 20pcs/ ESD Foam Tray

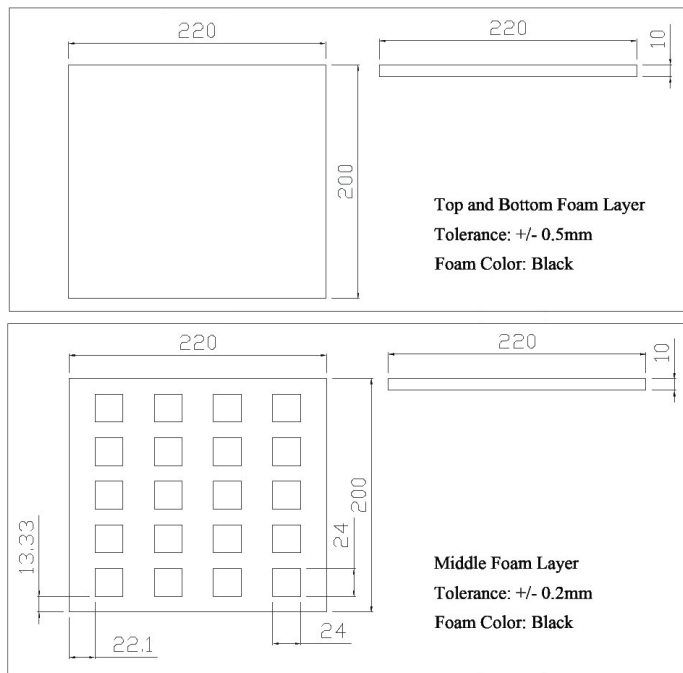

Dimensions: mm

**ATTENTION:** Abracon Corporation's products are COTS – Commercial-Off-The-Shelf products; suitable for Commercial, Industrial and, where designated, Automotive Applications. Abracon's products are not specifically designed for Military, Aviation, Aerospace, Life-dependant Medical applications or any application requiring high reliability where component failure could result in loss of life and/or property. For applications requiring high reliability and/or presenting an extreme operating environment, written consent and authorization from Abracon Corporation is required. Please contact Abracon Corporation for more information.

ABRACON IS  
ISO9001:2008  
CERTIFIED



2 Faraday, Suite# B | Irvine | CA 92618 Revised: 07.21.15  
Ph. 949.546.8000 | Fax. 949.546.8001  
Visit [www.abracon.com](http://www.abracon.com) for Terms and Conditions of Sale

## Looking for pricing, stock, or lifecycle information?

Click below to explore more details on WIN SOURCE:

- ⊖ [View AOCJY7TQ-X-100.000MHZ-1 on WIN SOURCE](#)
- ⊖ [Abracon LLC Information](#)

## Optimize Your Supply Chain with WIN SOURCE Solutions

- ✓ Global Sourcing Solution
- ✓ Obsolete Management
- ✓ Cost Control Management
- ✓ Shortage Management
- ✓ Alternative Solution
- ✓ Excess Inventory Management