



**THE DATASHEET OF  
AOC3860A**



### General Description

- Trench Power MOSFET technology
- Low  $R_{SS(ON)}$
- With ESD protection to improve battery performance and safety
- Common drain configuration for design simplicity
- RoHS and Halogen-Free Compliant

### Applications

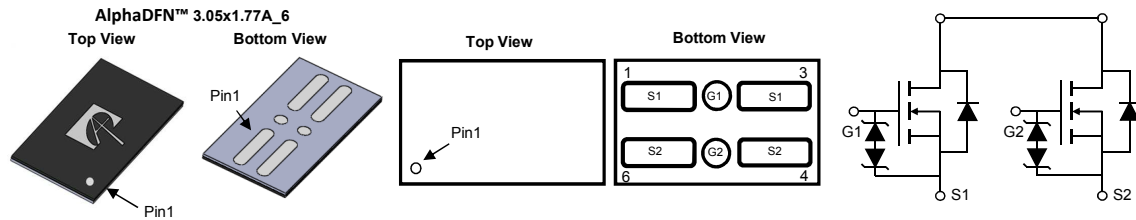
- Battery protection switch
- Mobile device battery charging and discharging

### Product Summary

$V_{SS}$	12V
$R_{SS(ON)}$ (at $V_{GS}=4.5V$ )	< 3.5m $\Omega$
$R_{SS(ON)}$ (at $V_{GS}=4.0V$ )	< 3.7m $\Omega$
$R_{SS(ON)}$ (at $V_{GS}=3.8V$ )	< 3.75m $\Omega$
$R_{SS(ON)}$ (at $V_{GS}=3.1V$ )	< 4.3m $\Omega$
$R_{SS(ON)}$ (at $V_{GS}=2.5V$ )	< 5m $\Omega$

### Typical ESD protection

HBM Class 2



Orderable Part Number	Package Type	Form	Minimum Order Quantity
AOC3860A	AlphaDFN 3.05x1.77A_6	Tape & Reel	8000

### Absolute Maximum Ratings $T_A=25^\circ C$ unless otherwise noted

Parameter	Symbol	Rating	Units
Source-Source Voltage	$V_{SS}$	12	V
Gate-Source Voltage	$V_{GS}$	$\pm 8$	V
Source Current(DC) <sup>Note1</sup>	$I_S$	25	A
Source Current(Pulse) <sup>Note2</sup>	$I_{SM}$	100	
Power Dissipation <sup>Note1</sup>	$P_D$	2.5	W
Junction and Storage Temperature Range	$T_J, T_{STG}$	-55 to 150	$^\circ C$

### Thermal Characteristics

Parameter	Symbol	Typical	Units
Maximum Junction-to-Ambient $t \leq 10s$	$R_{\theta JA}$	40	$^\circ C/W$
Maximum Junction-to-Ambient Steady-State		50	$^\circ C/W$

**Note 1.**  $I_S$  rated value is based on bare silicon. Mounted on 70mmx70mm FR-4 board.

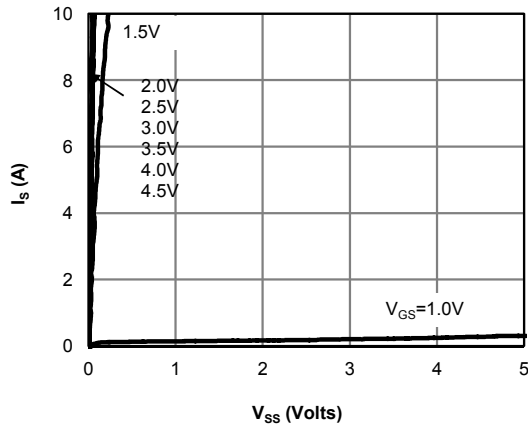
**Note 2.** PW < 10  $\mu s$  pulses, duty cycle 1% max.

**Electrical Characteristics (T<sub>J</sub>=25°C unless otherwise noted)**

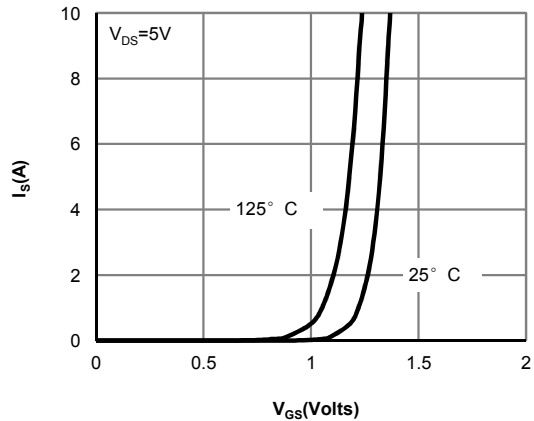
Symbol	Parameter	Conditions	Min	Typ	Max	Units
<b>STATIC PARAMETERS</b>						
BV <sub>SSS</sub>	Source-Source Breakdown Voltage	I <sub>S</sub> =250μA, V <sub>GS</sub> =0V Test Circuit 6	12			V
I <sub>SSS</sub>	Zero Gate Voltage Source Current	V <sub>SS</sub> =12V, V <sub>GS</sub> =0V Test Circuit 1 T <sub>J</sub> =55°C			1 5	μA
I <sub>GSS</sub>	Gate leakage current	V <sub>SS</sub> =0V, V <sub>GS</sub> =±8V Test Circuit 2			±10	μA
V <sub>GS(th)</sub>	Gate Threshold Voltage	V <sub>SS</sub> =V <sub>GS</sub> , I <sub>S</sub> =250μA Test Circuit 3	0.3	0.6	1.0	V
R <sub>SS(ON)</sub>	Static Source to Source On-Resistance	V <sub>GS</sub> =4.5V, I <sub>S</sub> =5A Test Circuit 4 T <sub>J</sub> =125°C	2.0	2.8	3.5	mΩ
			2.7	3.85	4.8	
		V <sub>GS</sub> =4.0V, I <sub>S</sub> =5A Test Circuit 4	2.1	2.9	3.7	mΩ
		V <sub>GS</sub> =3.8V, I <sub>S</sub> =5A Test Circuit 4	2.2	2.95	3.75	mΩ
		V <sub>GS</sub> =3.1V, I <sub>S</sub> =5A Test Circuit 4	2.3	3.2	4.3	mΩ
	V <sub>GS</sub> =2.5V, I <sub>S</sub> =5A Test Circuit 4	2.5	3.6	5.0	mΩ	
g <sub>FS</sub>	Forward Transconductance	V <sub>SS</sub> =5V, I <sub>S</sub> =5A Test Circuit 3		70		S
V <sub>FSS</sub>	Forward Source to Source Voltage	I <sub>S</sub> =1A, V <sub>GS</sub> =0V Test Circuit 5		0.56	1	V
<b>DYNAMIC PARAMETERS</b>						
R <sub>g</sub>	Gate resistance	f=1MHz		1.2		KΩ
<b>SWITCHING PARAMETERS</b>						
Q <sub>g</sub>	Total Gate Charge	V <sub>G1S1</sub> =4.5V, V <sub>SS</sub> =6V, I <sub>S</sub> =5A		44		nC
t <sub>D(on)</sub>	Turn-On DelayTime	V <sub>G1S1</sub> =4.5V, V <sub>SS</sub> =6V, R <sub>L</sub> =1.2Ω, R <sub>GEN</sub> =3Ω Test Circuit8		2		μs
t <sub>r</sub>	Turn-On Rise Time			4.5		μs
t <sub>D(off)</sub>	Turn-Off DelayTime			6		μs
t <sub>f</sub>	Turn-Off Fall Time			11		μs

APPLICATIONS OR USE AS CRITICAL COMPONENTS IN LIFE SUPPORT DEVICES OR SYSTEMS ARE NOT AUTHORIZED. AOS DOES NOT ASSUME ANY LIABILITY ARISING OUT OF SUCH APPLICATIONS OR USES OF ITS PRODUCTS. AOS RESERVES THE RIGHT TO IMPROVE PRODUCT DESIGN, FUNCTIONS AND RELIABILITY WITHOUT NOTICE.

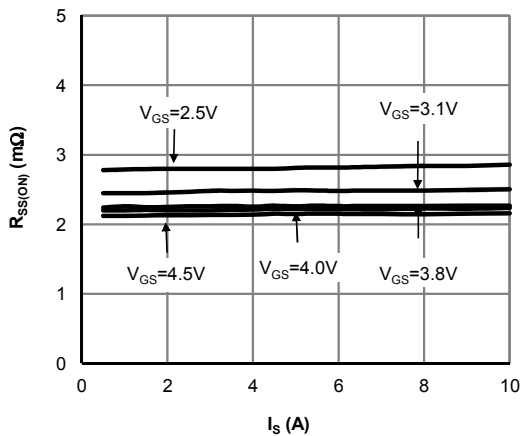
**TYPICAL ELECTRICAL AND THERMAL CHARACTERISTICS**



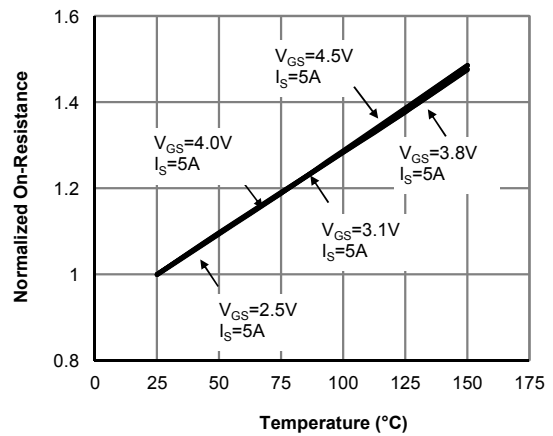
**Figure 1: On-Region Characteristics**



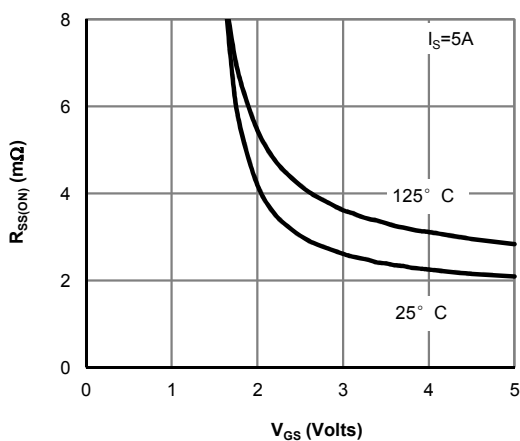
**Figure 2: Transfer Characteristics**



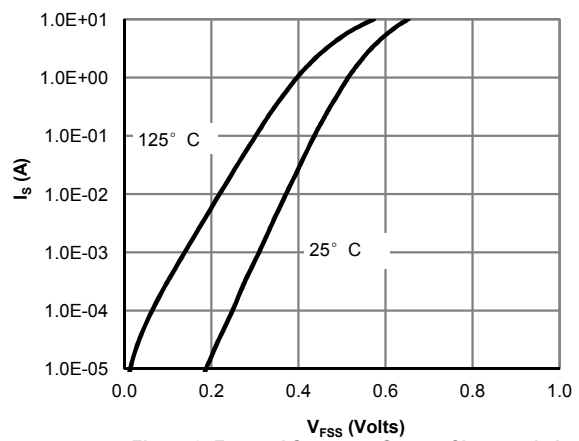
**Figure 3: On-Resistance vs. Source Current and Gate Voltage**



**Figure 4: On-Resistance vs. Junction Temperature**

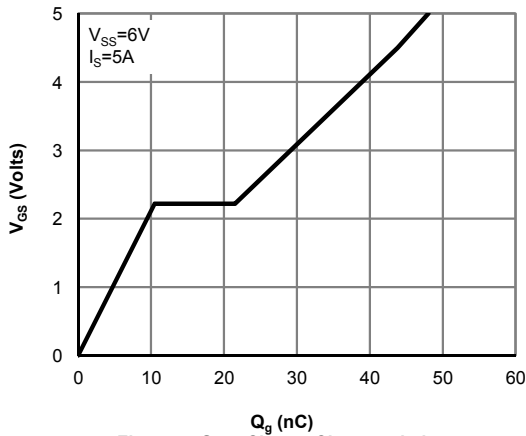


**Figure 5: On-Resistance vs. Gate-Source Voltage**

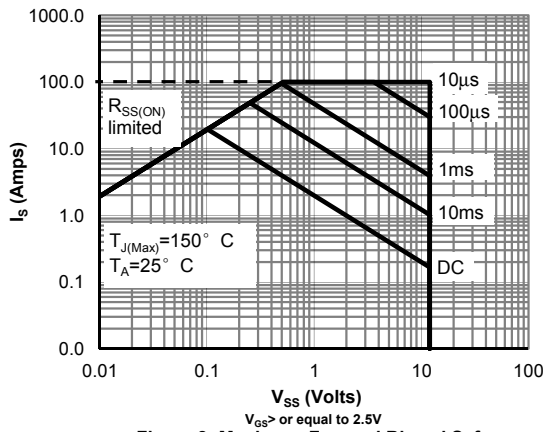


**Figure 6: Forward Source to Source Characteristics**

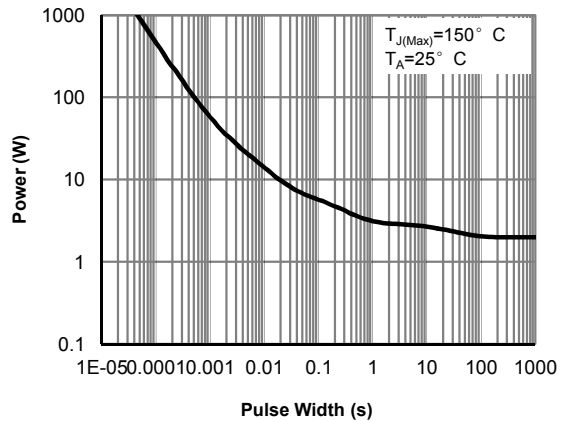
**TYPICAL ELECTRICAL AND THERMAL CHARACTERISTICS**



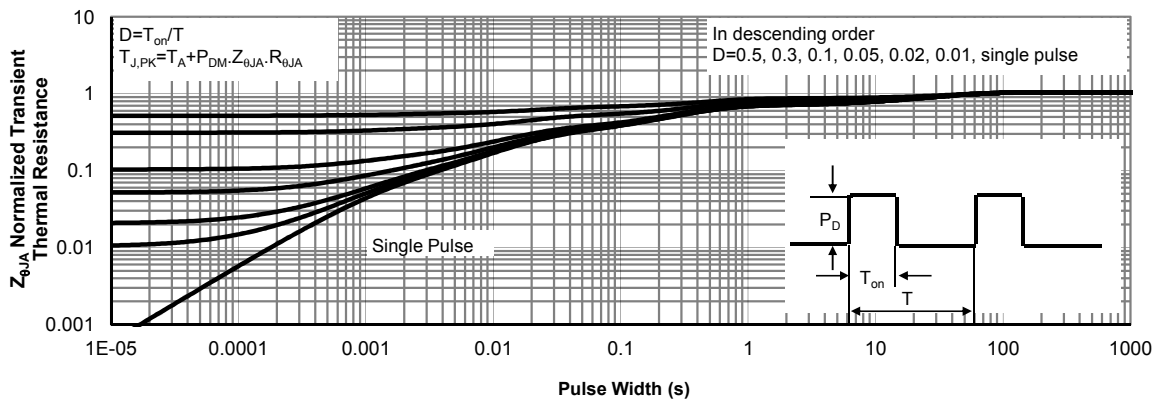
**Figure 7: Gate-Charge Characteristics**



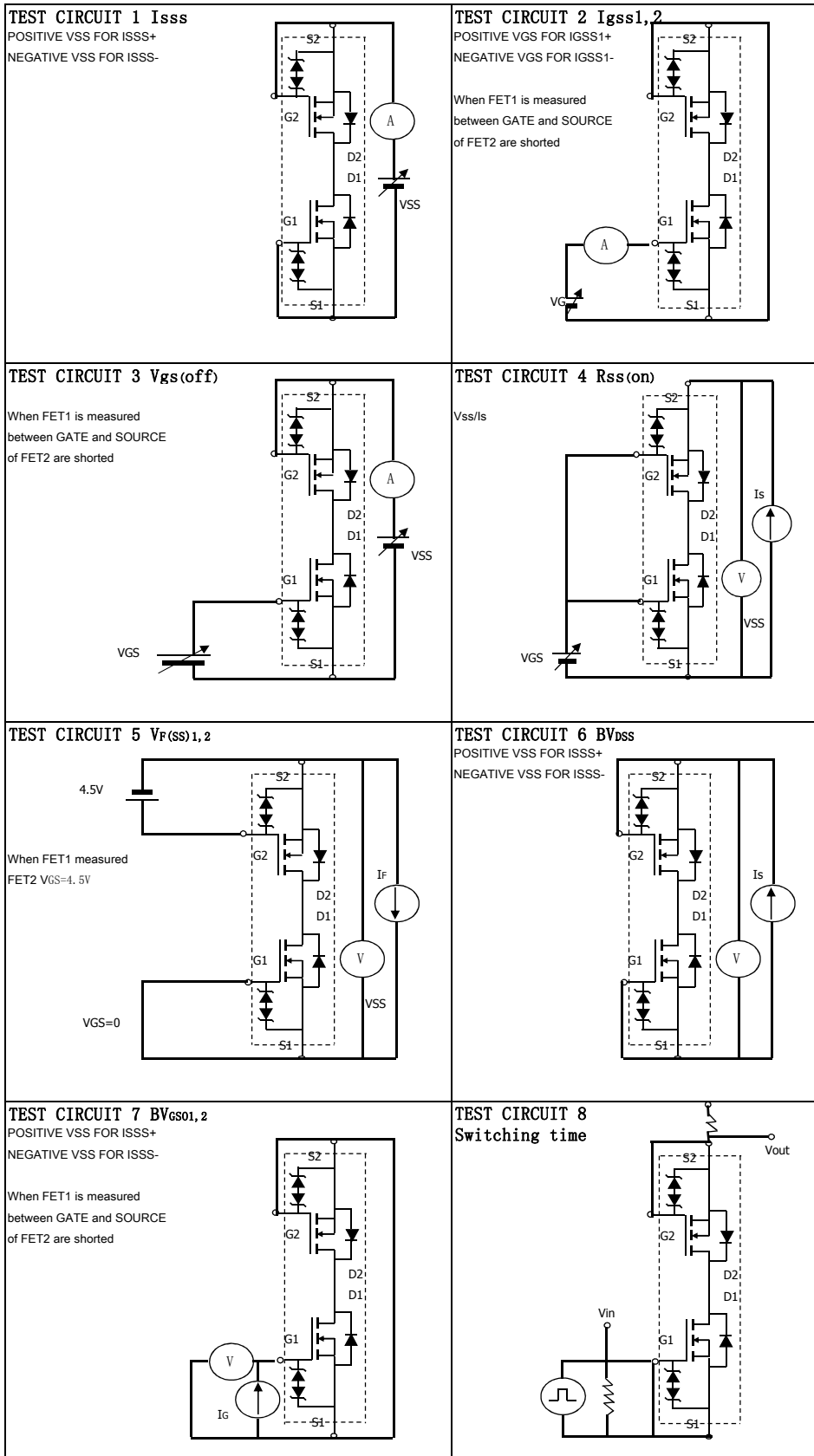
**Figure 8: Maximum Forward Biased Safe Operating Area (Note1)**



**Figure 9: Single Pulse Power Rating Junction-to-Ambient (Note1)**



**Figure 10: Normalized Maximum Transient Thermal Impedance (Note1)**



## Looking for pricing, stock, or lifecycle information?

Click below to explore more details on WIN SOURCE:

- ⊖ [View AOC3860A on WIN SOURCE](#)
- ⊖ [Alpha & Omega Semiconductor Inc. Information](#)

## Optimize Your Supply Chain with WIN SOURCE Solutions

- ✓ Global Sourcing Solution
- ✓ Obsolete Management
- ✓ Cost Control Management
- ✓ Shortage Management
- ✓ Alternative Solution
- ✓ Excess Inventory Management