



THE DATASHEET OF
AL1676-20CS7-13



Description

The AL1676 is a universal AC input (85~277 V_{AC}), high power factor (PF) and high efficiency Buck LED driver. The AL1676 topology provides accurate constant current (CC) with good line and load regulation, operating at boundary conduction mode (BCM) to ease in EMI/EMC qualification and testing to meet the latest regulatory laws.

The AL1676 single Buck stage driver works with a single winding inductor and High voltage MOSFET included, therefore, can use fewer external components and create a low bill of material (BOM) cost solution. The AL1676 has rich protection features to enhance system safety and reliability, including under voltage lock out (UVLO), LED open/short, over voltage, over current, over temperature protection and thermal fold-back function which can reduce output current when the driver's temperature is higher than the setting value.

The AL1676 is available for SO-7 package.

Features

- >90% Efficiency
- Universal 85 to 277 V_{AC} Input Range
- Multiple Options for Internal MOSFET
- Tight Output Current Tolerance: ±3%
- Low Startup Current: 100µA
- Low Operation Current: 170µA (5KHz Switching)
- Single Winding Inductor
- Internal Protections:
 - Under Voltage Lock Out (UVLO)
 - Leading-Edge Blanking (LEB)
 - Cycle-by-cycle Over Current Protection (OCP)
 - Output Open/Short Protection (OVP/OSP)
 - Thermal Fold-back Protection (TFP)
 - Over Temperature Protection (OTP)
- SO-7 Package
- **Totally Lead-Free & Fully RoHS Compliant (Notes 1 & 2)**
- **Halogen and Antimony Free. "Green" Device (Note 3)**

- Notes:
1. No purposely added lead. Fully EU Directive 2002/95/EC (RoHS) & 2011/65/EU (RoHS 2) compliant.
 2. See http://www.diodes.com/quality/lead_free.html for more information about Diodes Incorporated's definitions of Halogen- and Antimony-free, "Green" and Lead-free.
 3. Halogen- and Antimony-free "Green" products are defined as those which contain <900ppm bromine, <900ppm chlorine (<1500ppm total Br + Cl) and <1000ppm antimony compounds.

Pin Assignments

(Top View)

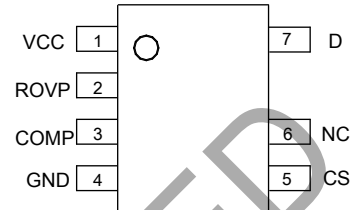

Applications

- Retrofit LED Lamps
- LED Tube
- High Voltage DC-DC LED Driver
- General Purpose Constant Current Source

Absolute Maximum Ratings (@ $T_A = +25^\circ\text{C}$, unless otherwise specified.) (Note 4)

Symbol	Parameter	Rating	Unit
V_{CC}	Power Supply Voltage	18	V
V_D	Voltage on D Pin (AL1676-20AS7-13)	300	V
	Voltage on D Pin (AL1676-30AS7-13)	300	V
	Voltage on D Pin (AL1676-10BS7-13)	500	V
	Voltage on D Pin (AL1676-20BS7-13)	500	V
	Voltage on D Pin (AL1676-20CS7-13)	600	V
	Voltage on D Pin (AL1676-40DCS7-13)	670	V
I_D	Continuous Drain Current $T_C = +25^\circ\text{C}$ (AL1676-20AS7-13)	2.0	A
	Continuous Drain Current $T_C = +25^\circ\text{C}$ (AL1676-30AS7-13)	3.0	A
	Continuous Drain Current $T_C = +25^\circ\text{C}$ (AL1676-10BS7-13)	1.0	A
	Continuous Drain Current $T_C = +25^\circ\text{C}$ (AL1676-20BS7-13)	2.0	A
	Continuous Drain Current $T_C = +25^\circ\text{C}$ (AL1676-20CS7-13)	2.0	A
	Continuous Drain Current $T_C = +25^\circ\text{C}$ (AL1676-40DS7-13)	4.0	A
V_{CS}	Voltage on CS Pin	-0.3 to 7	V
V_{ROVP}	Voltage on ROVP Pin	-0.3 to 7	V
T_J	Operating Junction Temperature	-40 to +150	$^\circ\text{C}$
T_{STG}	Storage Temperature	-65 to +150	$^\circ\text{C}$
T_{LEAD}	Lead Temperature (Soldering, 10 seconds)	+260	$^\circ\text{C}$
P_D	Power Dissipation and Thermal Characteristics ($T_A = +50^\circ\text{C}$)	0.8	W
θ_{JA}	Thermal Resistance (Junction to Ambient) (Note 5)	123	$^\circ\text{C}/\text{W}$
θ_{JC}	Thermal Resistance (Junction to Case) (Note 5)	19	$^\circ\text{C}/\text{W}$
-	ESD (Human Body Model)	2000	V
	ESD (Machine Model)	200	V

- Notes:
- Stresses greater than those listed under "Absolute Maximum Ratings" may cause permanent damage to the device. These are stress ratings only, and functional operation of the device at these or any other conditions beyond those indicated under "Recommended Operating Conditions" is not implied. Exposure to "Absolute Maximum Ratings" for extended periods may affect device reliability.
 - Device mounted on 1"x1" FR-4 substrate PCB, 2oz copper, with minimum recommended pad layout.

Recommended Operating Conditions (@ $T_A = +25^\circ\text{C}$, unless otherwise specified.)

Symbol	Parameter	Min	Max	Unit
T_A	Ambient Temperature (Note 6)	-40	+105	$^\circ\text{C}$

Note 6: The device can operate normally at +125 $^\circ\text{C}$ ambient temperature under the condition that the junction temperature is less than +150 $^\circ\text{C}$.

Electrical Characteristics (@T_A = +25°C, unless otherwise specified.)

Symbol	Parameter	Conditions	Min	Typ	Max	Unit
UVLO						
V _{TH(ST)}	Startup Voltage	–	–	14.5	–	V
V _{OPR(Min)}	Minimal Operating Voltage	After Turn On	–	8.5	–	V
V _{CC_CLAMP}	VCC Clamp Voltage	I _{CC} = 1mA	–	15.5	–	V
Standby Current						
I _{ST}	Start-up Current	V _{CC} = V _{TH(ST)} - 0.5V, Before Start up	–	100	–	μA
I _{CC(OPR)}	Operating Current	Switching Frequency at 5kHz	–	170	–	μA
Internal High Voltage MOSFET						
R _{DS(ON)}	Drain-Source On-State Resistance	AL1676-20AS7-13	–	–	6.5	Ω
		AL1676-30AS7-13	–	–	3	
		AL1676-10BS7-13	–	–	12	
		AL1676-20BS7-13	–	–	6	
		AL1676-20CS7-13	–	–	5.5	
		AL1676-40DS7-13	–	–	2.5	
I _{DS}	Continuous Drain-Source Current	AL1676-20AS7-13	–	–	2.0	A
		AL1676-30AS7-13	–	–	3.0	
		AL1676-10BS7-13	–	–	1.0	
		AL1676-20BS7-13	–	–	2.0	
		AL1676-20CS7-13	–	–	2.0	
		AL1676-40DS7-13	–	–	4.0	
V _{DS}	Drain-Source Voltage	AL1676-20AS7-13	300	–	–	V
		AL1676-30AS7-13	300	–	–	
		AL1676-10BS7-13	500	–	–	
		AL1676-20BS7-13	500	–	–	
		AL1676-20CS7-13	600	–	–	
		AL1676-40DS7-13	650	–	–	
I _{DSS}	Drain-Source Leakage Current	AL1676-20AS7-13	–	–	1	μA
		AL1676-30AS7-13	–	–	1	
		AL1676-10BS7-13	–	–	1	
		AL1676-20BS7-13	–	–	1	
		AL1676-20CS7-13	–	–	1	
		AL1676-40DS7-13	–	–	1	

Electrical Characteristics (@ $T_A = +25^\circ\text{C}$, unless otherwise specified.) (Cont.)

Symbol	Parameter	Conditions	Min	Typ	Max	Unit
ROVP						
V_{ROVP}	Reference Voltage of ROVP Pin	–	–	0.5	–	V
Current Sense						
V_{REF}	Internal Reference Voltage	–	–	0.400	–	V
V_{CS_CLAMP}	VCS Clamp Voltage	–	–	0.8	–	V
t_{ON_MIN}	Minimum t_{ON}	–	–	550	–	ns
t_{ON_MAX}	Maximum t_{ON}	–	–	29	–	μs
t_{OFF_MAX}	Maximum t_{OFF}	–	–	180	–	μs
t_{OFF_MIN}	Minimum t_{OFF} (Note 7)	–	–	6	–	μs
Error Amplifier						
Gm	Gm Trans-conductance	–	–	25	–	$\mu\text{A/V}$
I_{SOURCE}	Amplifier Source Current	–	–	10	–	μA
I_{SINK}	Amplifier Sink Current	–	–	9	–	μA
Thermal Foldback and Over Temperature Protection						
T_{REG}	Overheating Temperature Regulation (Note 7)	–	–	+150	–	$^\circ\text{C}$
–	Shutdown Temperature (Notes 7, 8)	–	–	+170	–	$^\circ\text{C}$

- Notes:
7. These parameters, although guaranteed by design, are not 100% tested in production.
 8. The device will latch off when OTP happens, recovered after power cycle and device won't operating normally at this temperature.

NOT RECOMMENDED FOR NEW DESIGN

Performance Characteristics (Note 9)

Start-up Voltage vs. Ambient Temperature

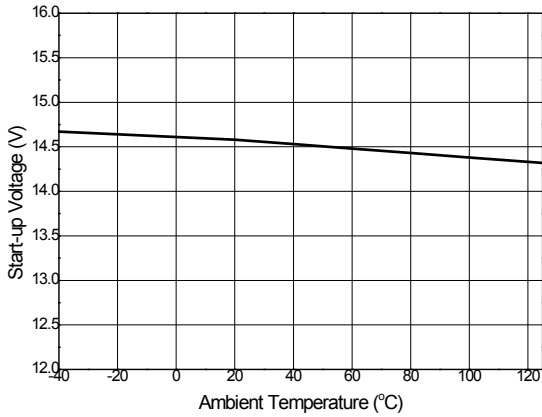

Start-up Current vs. Ambient Temperature

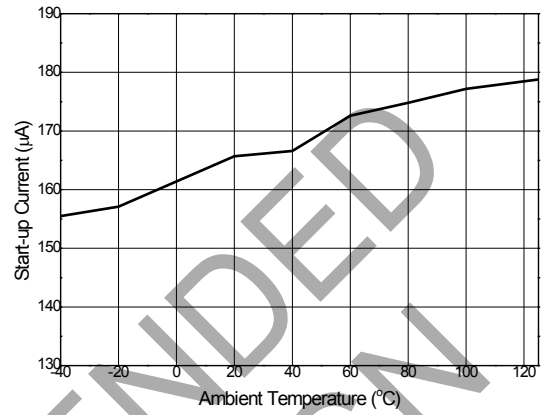

Minimal Operating Voltage vs. Ambient Temperature

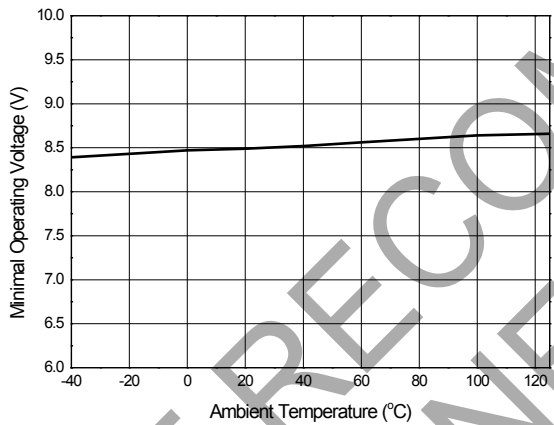

Operating Current vs. Ambient Temperature

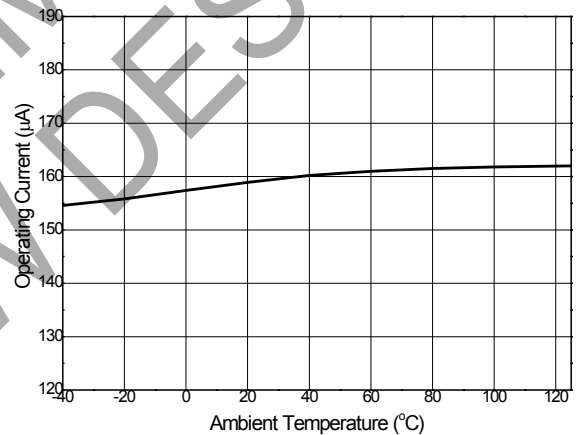

V_{REF} vs. Ambient Temperature

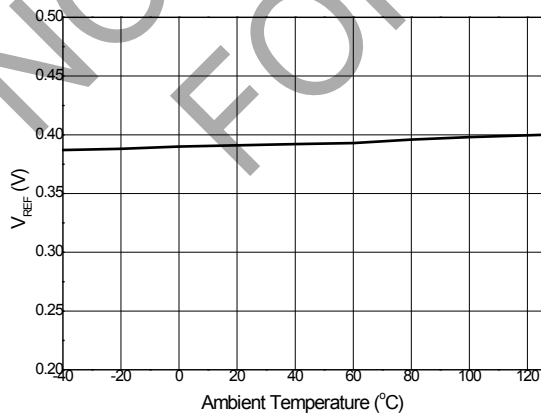

V_{ROVP} Reference vs. Ambient Temperature

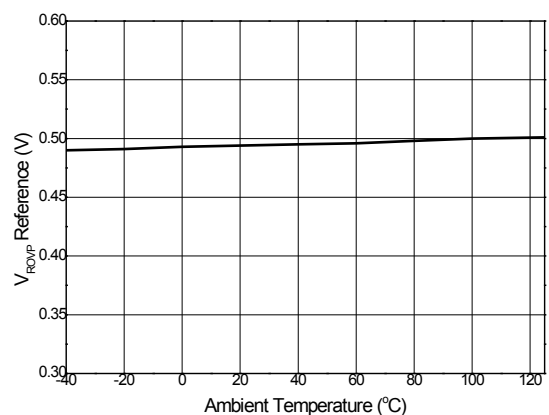

Performance Characteristics (Cont.) (Note 9)

VCC Clamp Voltage vs. Ambient Temperature

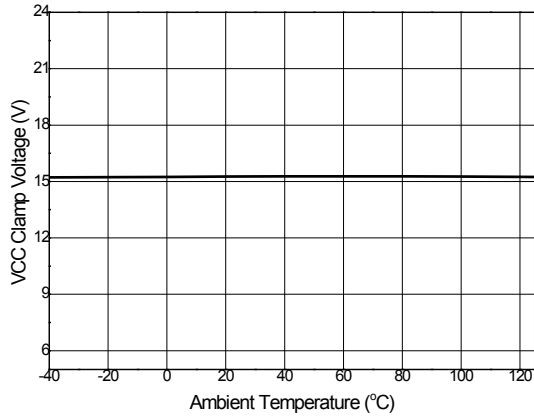

V_{REF} vs. Ambient Temperature

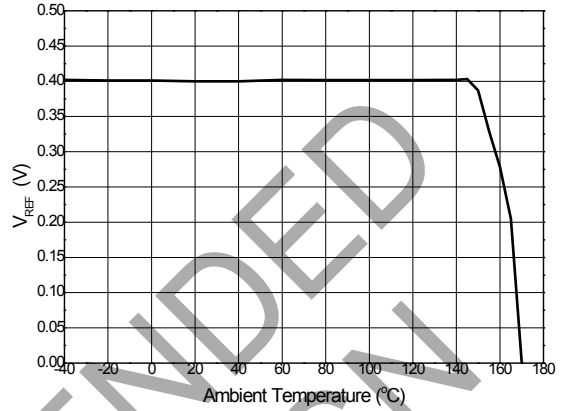

Note 9: These electrical characteristics are tested under DC condition. The ambient temperature is equal to the junction temperature of the device.

NOT RECOMMENDED FOR NEW DESIGN

Functional Description and Application Information

Convertor Operation

The AL1676 is a high efficiency and high power factor BUCK LED driver solution for universal input application based on single winding inductor. It is available for 6 internal MOSFET options (300V/2A, 300V/3A, 500/1A, 500V/2A, 600V/2A, 650V/4A) which can help to reduce the overall LED driver solution size of the LED lamp. This 6 MOSFET options can cover most of the 3~18W applications.

High power factor (PF) is achieved by constant on-time control. Coupled with simple closed loop of constant current control, the AL1676 can achieve good line and load regulation. The AL1676 adopts source-driver technique to decrease the system operating current. It uses a novel method to detect the t_{OFF} time which helps to get rid of an auxiliary winding for (V_{CC} supply and) detecting the t_{OFF} time, resulting in an extremely low bill material (BOM). The AL1676 operates at boundary conduction mode (BCM) which can ease EMI design.

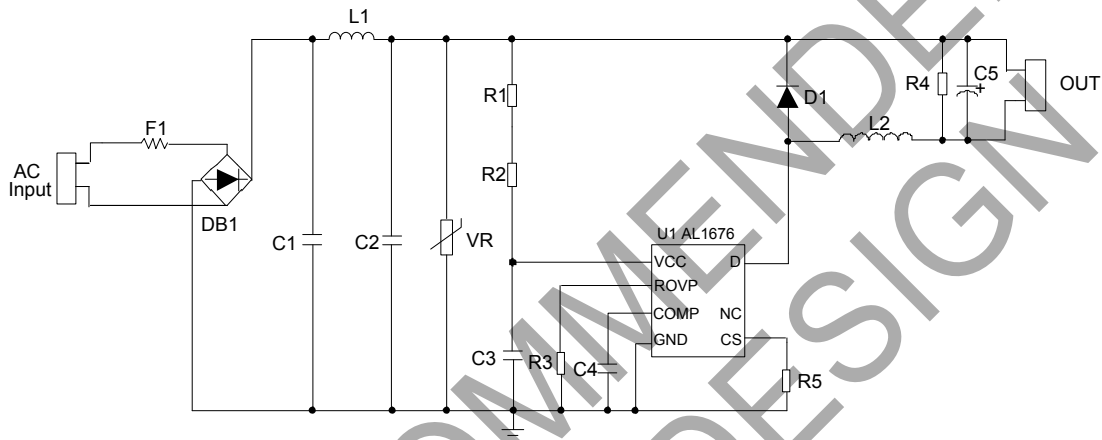

Figure 1. Typical Application Circuit

Start-up and Supply Voltage

Before start-up, the VCC capacitor C3 is charged by the startup resistors (R1, R2) from the high voltage mains. When the start-up voltage is reached, the AL1676 starts switching. During normal operation, the VCC supply is provided by start-up resistors (R1, R2) and internal source driver circuit.

The AL1676 has an internal VCC clamp voltage (typical 15.5V), which is limited by one internal active Zener diode.

When VCC voltage drops to below the under voltage lockout (UVLO), switching stops, the IC can restart when the voltage on VCC pin is exceeding the startup voltage ($V_{TH(ST)}$).

Protections

Under Voltage Lockout (UVLO)

When the voltage on the VCC pin drops to below $V_{OPR(Min)}$, the IC stops switching. The IC can restart when the voltage on VCC exceeds the startup voltage ($V_{TH(ST)}$).

Leading-Edge Blanking (LEB)

To prevent false detection of the peak current of the inductor, a blanking time following switch-on is designed. When the internal switch turns on, a short current spike can occur because of the capacitive discharge of the voltage over the drain and source. It is disregarded during the LEB time (t_{ON_MIN}).

Cycle-by-cycle Over Current Protection (OCP)

The AL1676 has a built-in peak current detector. It triggers when the voltage on CS pin reaches the peak level V_{CS_CLAMP} . The R5 is connected to the CS pin to sense the current of the inductor. The maximum peak current ($I_{PEAK(MAX)}$) of the inductor can be calculated as below:

$$I_{PEAK(MAX)} = \frac{V_{CS_CLAMP}}{R5} \dots\dots\dots (1)$$

Functional Description and Application Information (Cont.)

The detection circuit is activated after the LEB time. When the detection circuit sense the CS voltage is higher than 1V, the IC will turn off the switch to limit the output current. It automatically provides protection for the maximum LED current during operation. A propagation delay exists between over current detection and actual source-switch off, so the actual peak current is a little higher than the OCP level set by the R5.

Over-Voltage Protection and Output-Open Protection (OVP)

The AL1676 has output open voltage protection when the LED is open, which can prevent the output voltage from increasing to a very high value. This feature can help the system designer to select a smaller volume capacitor. The output voltage is set by the external resistor R3 shown in Figure 1.

When LED is open, the t_{OFF_OVP} time can be calculated as:

$$t_{OFF_OVP} = \frac{L1 \cdot V_{CS}}{V_{OVP} \cdot R5} \dots\dots\dots (2)$$

Where,

V_{OVP} is the output open voltage.

V_{CS} is the voltage on the CS pin when OVP happens.

The output voltage is set by R3, and R3 is calculated as:

$$R3 = \frac{V_{ROVP_REF} \cdot t_{OFF_OVP}}{20 \cdot C_{REF} \cdot V_{CS}} = \frac{V_{ROVP_REF} \cdot L1}{20 \cdot C_{REF} \cdot V_{OVP} \cdot R5} \dots\dots\dots (3)$$

Where, V_{ROVP_REF} is the internal ROVP pin 0.5V's reference, C_{REF} is the internal 6pF capacitor.

Output-Short Protection (OSP)

When LED is shorted, the device cannot detect the t_{OFF} time, and the device controls the system operating at 5kHz low switching frequency.

Thermal Foldback Protection (TFP)

The AL1676 has a thermal foldback function and adopts self-adaptive control method, which can prevent the system from breaking down caused by high temperature. The overheating temperature is set at +150°C typical, when the junction temperature of the IC is higher than +150°C typical, the device will linearly decrease the internal reference voltage to decrease the output current. As a result of this feature, the device can control the system's output power at high ambient temperature, to control the quantity of heat of the system. This enhances the safety of the system at high temperature.

The thermal foldback waveform is shown below:

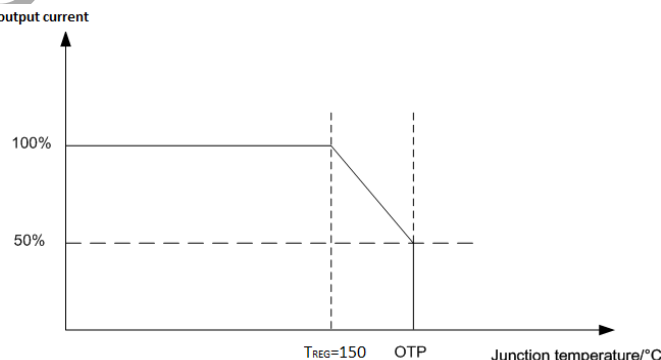

Figure 2. Thermal Foldback Waveform

Functional Description and Application Information (Cont.)

Over-Temperature Protection (OTP)

The AL1676 has OTP protection function. When the junction temperature reaches +170°C typical, the IC will trigger an over-temperature protection condition which causes the device to shut down and latch. Once OTP has triggered, the system will resume after the system's input power supply has been reset and power up.

Design Parameters

Setting the Current Sense Resistor R5

In buck structure, when output is larger than input, no energy will be transferred to output, this period is called dead zone, and the dead zone angle is θ .

$$\theta = a \sin \frac{V_o}{\sqrt{2} \cdot V_{IN_RMS}} \dots \dots \dots (4)$$

Where,

V_o is the output voltage.

V_{IN_RMS} is the RMS value of the input voltage.

The AL1676 adopts boundary conduction mode, the output current is calculated as below,

$$I_{O_MEAN} = \frac{1}{\pi} \cdot \int_{\theta}^{\pi-\theta} \frac{1}{2} \cdot I_{PEAK} \left(\sin(\theta) - \frac{V_o}{\sqrt{2} V_{IN_RMS}} \right) \cdot \frac{t_{ON} + t_{OFF}}{t_{ON} + t_{OFF} + t_{DELAY}} dt \dots \dots \dots (5)$$

Where,

I_{PEAK} is the peak current of the inductance.

t_{ON} is the internal MOSFET on time.

t_{OFF} is the freewheel diode D1's conduction time.

t_{DELAY} is typically 0.15µs.

The AL1676 is a closed loop constant current control, so it has the equation.

$$V_{REF} = \frac{1}{\pi} \cdot \int_{\theta}^{\pi-\theta} I_{PEAK} \left(\sin(\theta) - \frac{V_o}{\sqrt{2} V_{IN_RMS}} \right) \cdot R5 \cdot \frac{t_{ON} + t_{OFF}}{t_{ON} + t_{OFF} + t_{DELAY}} dt \dots \dots \dots (6)$$

Where,

V_{REF} is the internal reference, typical 0.4V, R5 is the current sense resistor.

So we can get the output current equation as below,

$$I_{O_MEAN} = \frac{1}{2} \cdot \frac{V_{REF}}{R5} \dots \dots \dots (7)$$

Inductance Selection (L1)

In buck structure, the peak current of the inductor can be calculated as below,

$$I_{PEAK} = \frac{\pi \cdot V_{REF}}{R5 \cdot \int_{\theta}^{\pi-\theta} \left(\sin(\theta) - \frac{V_o}{\sqrt{2} V_{IN_RMS}} \right) \cdot \frac{t_{ON} + t_{OFF}}{t_{ON} + t_{OFF} + t_{DELAY}} dt} \dots \dots \dots (8)$$

Functional Description and Application Information (Cont.)

The AL1676 controls the system operating at boundary conduction mode which results in its operating frequency inconstant. To set the minimum switching frequency f_{MIN} at the crest of the minimum AC input.

$$L2 = \frac{(\sqrt{2}V_{IN_RMS} - V_O) \cdot V_O}{I_{PEAK} \cdot \sqrt{2}V_{IN_RMS} \cdot f_{MIN}} \dots\dots\dots (9)$$

According to the Faraday's Law of Induction, the winding number of the inductance can be calculated by:

$$N_{L2} = \frac{L2 \cdot I_{PEAK}}{A_e \cdot B_m} \dots\dots\dots (10)$$

Where,

A_e is the core effective area.

B_m is the maximum magnetic flux density.

The AL1676 has designed the minimum t_{ON} time and maximum t_{ON} time, the t_{ON_MIN} is about 700ns and the t_{ON_MAX} time is about 29 μ s. In buck topology there is the equation $V_{IN_RMS} - V_O = L \cdot I_{PEAK} / t_{ON}$. If the inductance is too small, it will make t_{ON} smaller than t_{ON_MIN} , the device cannot detect the peak current of the system, resulting in incorrect output current. If the inductance is too large, make t_{ON} longer than the t_{ON_MAX} , the system's output current will decrease because of the limit of the t_{ON_MAX} .

The AL1676 has also the limitation of minimum t_{OFF} time and maximum t_{OFF} time, the t_{OFF_MIN} time is about 6 μ s and t_{OFF_MAX} time is about 180 μ s. In buck topology there is the equation $V_O = L \cdot I_{PEAK} / t_{OFF}$. If the inductance is too small, make t_{OFF} smaller than t_{OFF_MIN} , the system will enter DCM mode, and the output current will be incorrect. If the inductance is too large, make t_{OFF} longer than t_{OFF_MAX} , the system will enter CCM mode, and the output current will also be incorrect. So a suitable value of the inductance is very important.

Consider these parameters, two examples of the typical application inductance is recommended as below:

System spec	Inductance Value	System Frequency	t_{ON_MIN}	t_{OFF}
60V/100mA (85~265V _{AC})	2.2mH	64KHz(230 V _{AC})	2.4 μ s (265 V _{AC})	12.6 μ s
42V/150mA (85~265 V _{AC})	1.1mH	64KHz(230 V _{AC})	1.6 μ s (265 V _{AC})	13.5 μ s

Recommended Applications

The AL1676 integrates different MOSFET to adapt different wattage application. The output current is limited by the integrated MOSFET, and the SO-7 package's heat dissipation capability. The minimum output voltage is limited by the LEB time, and the minimum output voltage is recommended to 20V. The recommended application is given below:

Device	Output Power Coverage	Maximum Output Current	Minimum Output Voltage
AL1676-20A	≤10W	≤200mA	20V
AL1676-30A	≤13W	≤300mA	20V
AL1676-10B	≤7W	≤120mA	20V
AL1676-20B	≤10W	≤200mA	20V
AL1676-20C	≤10W	≤200mA	20V
AL1676-40D	≤18W	≤350mA	20V

Ordering Information

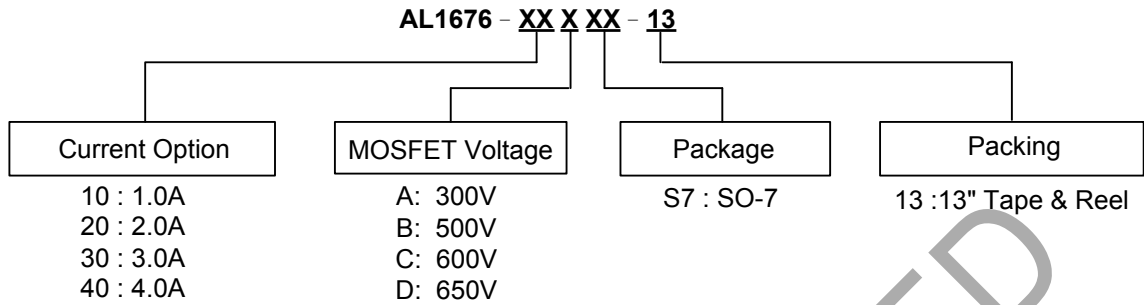

Part Number	Package code	Package	13" Tape and Reel	
			Quantity	Part Number Suffix
AL1676-20AS7-13	S7	SO-7	4000/Tape & Reel	-13
AL1676-30AS7-13	S7	SO-7	4000/Tape & Reel	-13
AL1676-10BS7-13	S7	SO-7	4000/Tape & Reel	-13
AL1676-20BS7-13	S7	SO-7	4000/Tape & Reel	-13
AL1676-20CS7-13	S7	SO-7	4000/Tape & Reel	-13
AL1676-40DS7-13	S7	SO-7	4000/Tape & Reel	-13

Marking Information

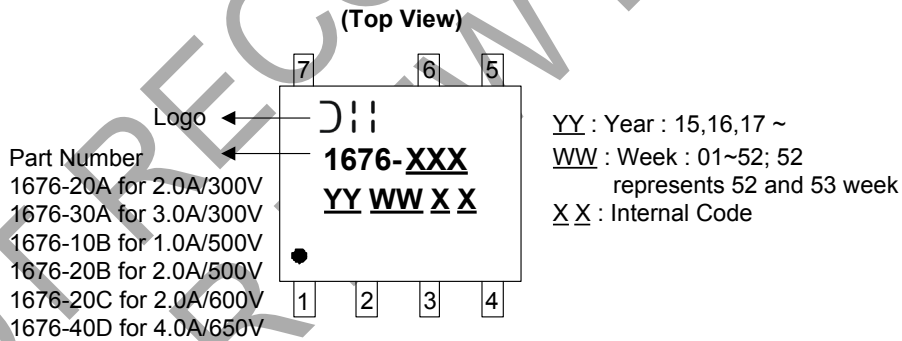

Package Outline Dimensions (All dimensions in mm.)

(1) Package Type: SO-7

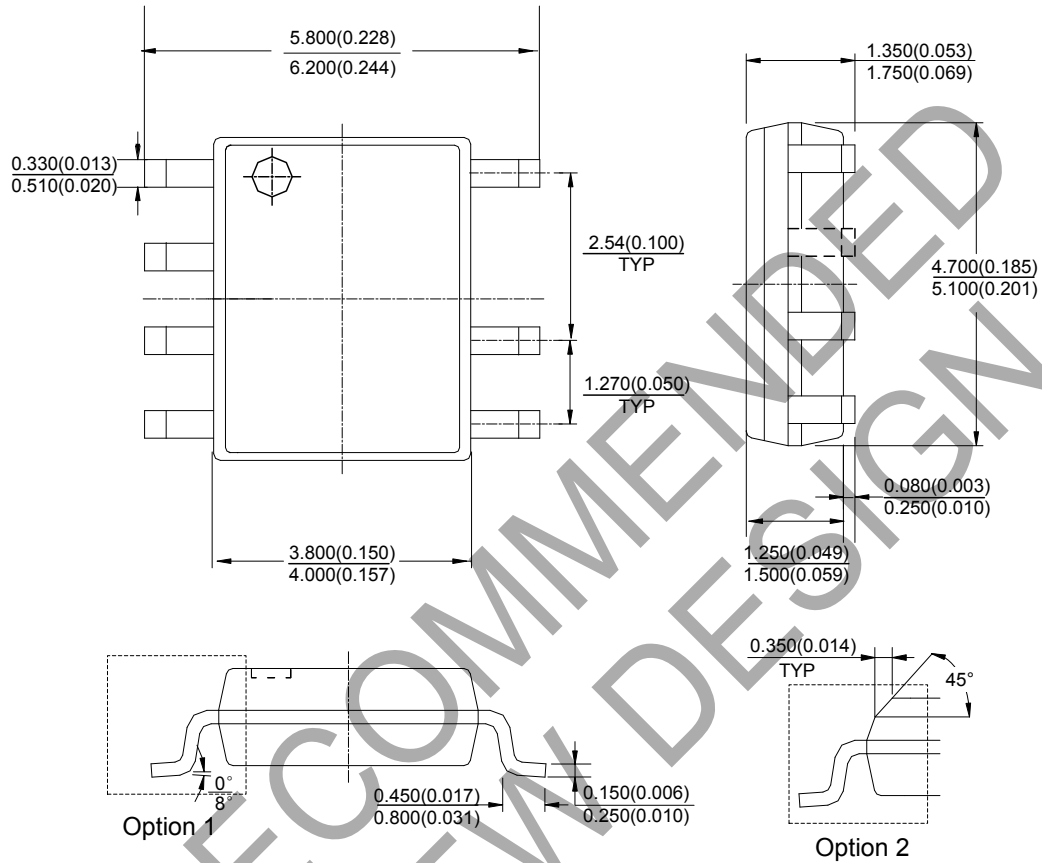

Note: Eject hole, oriented hole and mold mark is optional.

NOT RECOMMENDED FOR NEW DESIGN

Suggested Pad Layout

(1) Package Type: SO-7

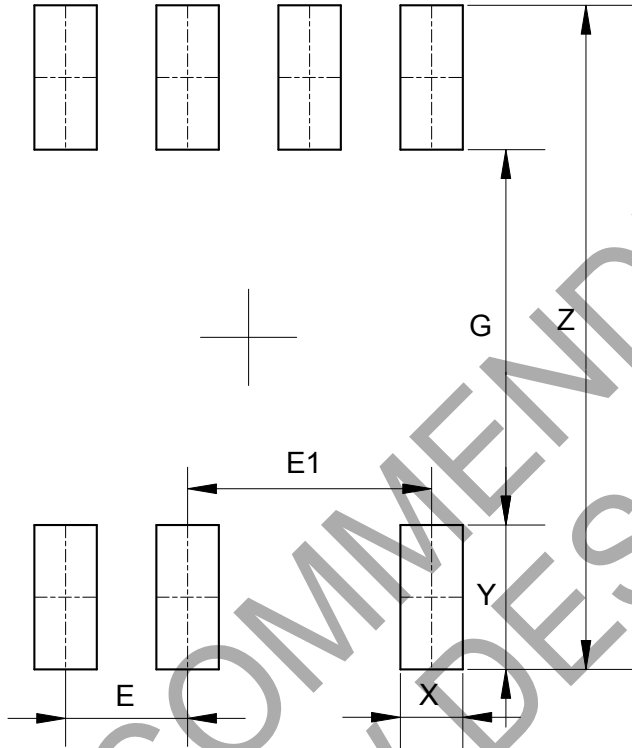

Dimensions	Z (mm)/(inch)	G (mm)/(inch)	X (mm)/(inch)	Y (mm)/(inch)	E (mm)/(inch)	E1 (mm)/(inch)
Value	6.900/0.272	3.900/0.154	0.650/0.026	1.500/0.059	1.270/0.050	2.540/0.100

NOT RECOMMENDED FOR NEW DESIGN

IMPORTANT NOTICE

1. DIODES INCORPORATED AND ITS SUBSIDIARIES (“DIODES”) MAKE NO WARRANTY OF ANY KIND, EXPRESS OR IMPLIED, WITH REGARDS TO ANY INFORMATION CONTAINED IN THIS DOCUMENT, INCLUDING, BUT NOT LIMITED TO, THE IMPLIED WARRANTIES OF MERCHANTABILITY, FITNESS FOR A PARTICULAR PURPOSE OR NON-INFRINGEMENT OF THIRD PARTY INTELLECTUAL PROPERTY RIGHTS (AND THEIR EQUIVALENTS UNDER THE LAWS OF ANY JURISDICTION).
2. The Information contained herein is for informational purpose only and is provided only to illustrate the operation of Diodes products described herein and application examples. Diodes does not assume any liability arising out of the application or use of this document or any product described herein. This document is intended for skilled and technically trained engineering customers and users who design with Diodes products. Diodes products may be used to facilitate safety-related applications; however, in all instances customers and users are responsible for (a) selecting the appropriate Diodes products for their applications, (b) evaluating the suitability of the Diodes products for their intended applications, (c) ensuring their applications, which incorporate Diodes products, comply the applicable legal and regulatory requirements as well as safety and functional-safety related standards, and (d) ensuring they design with appropriate safeguards (including testing, validation, quality control techniques, redundancy, malfunction prevention, and appropriate treatment for aging degradation) to minimize the risks associated with their applications.
3. Diodes assumes no liability for any application-related information, support, assistance or feedback that may be provided by Diodes from time to time. Any customer or user of this document or products described herein will assume all risks and liabilities associated with such use, and will hold Diodes and all companies whose products are represented herein or on Diodes’ websites, harmless against all damages and liabilities.
4. Products described herein may be covered by one or more United States, international or foreign patents and pending patent applications. Product names and markings noted herein may also be covered by one or more United States, international or foreign trademarks and trademark applications. Diodes does not convey any license under any of its intellectual property rights or the rights of any third parties (including third parties whose products and services may be described in this document or on Diodes’ website) under this document.
5. Diodes products are provided subject to Diodes’ Standard Terms and Conditions of Sale (<https://www.diodes.com/about/company/terms-and-conditions/terms-and-conditions-of-sales/>) or other applicable terms. This document does not alter or expand the applicable warranties provided by Diodes. Diodes does not warrant or accept any liability whatsoever in respect of any products purchased through unauthorized sales channel.
6. Diodes products and technology may not be used for or incorporated into any products or systems whose manufacture, use or sale is prohibited under any applicable laws and regulations. Should customers or users use Diodes products in contravention of any applicable laws or regulations, or for any unintended or unauthorized application, customers and users will (a) be solely responsible for any damages, losses or penalties arising in connection therewith or as a result thereof, and (b) indemnify and hold Diodes and its representatives and agents harmless against any and all claims, damages, expenses, and attorney fees arising out of, directly or indirectly, any claim relating to any noncompliance with the applicable laws and regulations, as well as any unintended or unauthorized application.
7. While efforts have been made to ensure the information contained in this document is accurate, complete and current, it may contain technical inaccuracies, omissions and typographical errors. Diodes does not warrant that information contained in this document is error-free and Diodes is under no obligation to update or otherwise correct this information. Notwithstanding the foregoing, Diodes reserves the right to make modifications, enhancements, improvements, corrections or other changes without further notice to this document and any product described herein. This document is written in English but may be translated into multiple languages for reference. Only the English version of this document is the final and determinative format released by Diodes.
8. Any unauthorized copying, modification, distribution, transmission, display or other use of this document (or any portion hereof) is prohibited. Diodes assumes no responsibility for any losses incurred by the customers or users or any third parties arising from any such unauthorized use.

Copyright © 2021 Diodes Incorporated

www.diodes.com

Looking for pricing, stock, or lifecycle information?

Click below to explore more details on WIN SOURCE:

- ⊖ [View AL1676-20CS7-13 on WIN SOURCE](#)
- ⊖ [Diodes Incorporated Information](#)

Optimize Your Supply Chain with WIN SOURCE Solutions

- ✓ Global Sourcing Solution
- ✓ Obsolete Management
- ✓ Cost Control Management
- ✓ Shortage Management
- ✓ Alternative Solution
- ✓ Excess Inventory Management