



**THE DATASHEET OF  
AH9246-P-B**



## Description

The AH9246 is an ultra high sensitivity Hall-effect switch with internal pull-up resistor on the output, designed for battery operated handheld equipments to industrial applications.

A chopper stabilized architecture improves stability of magnetic switch points over the whole operating range. A sleep-awake logic controls the sleep and awake time to reduce the average operating current of the device. During the awake time, the output is changed with the magnetic flux density. During the sleep time, the output is latched in its previous state and the current consumption reduces to 4 $\mu$ A typical at 3V. The average current consumption is 8 $\mu$ A at 3V.

The output can be switched on with either north or south pole of sufficient strength. If the magnetic flux density perpendicular to the part marking surface is larger than operating point ( $B_{OP}$ ), the output will be turned on; if it is less than releasing point ( $B_{RP}$ ), the output will be turned off.

The AH9246 is available in industry standard TO92S and SC59 packages.

## Features

- Omnipolar Operation (Switching with North or South Poles)
- Micropower Operation
- Built in Pull-up Resistor on the Output
- 2.5V to 5.5V Power Supply
- Stabilized Chopper
- Superior Temperature Stability
- Digital Output Signal
- -40°C to +85°C Operating Temperature
- ESD (HBM): 5000V
- Small Low Profile Industry Standard SC59 and TO92S Packages
- **Totally Lead-Free & Fully RoHS Compliant (Notes 1 & 2)**
- **Halogen and Antimony Free. "Green" Device (Note 3)**

## Pin Assignments

(Front View)

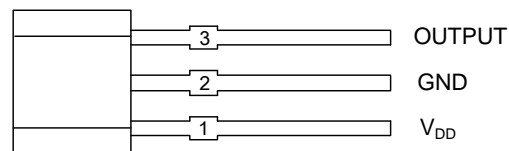

**TO92S**

(Top View)

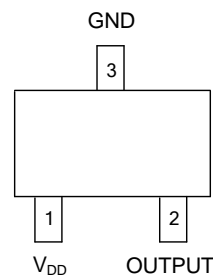

**SC59**

## Applications

- Cover Switch in Notebook PC/PDA
- Handheld Wireless Application Awake Switch
- Magnet Switch in Low Duty Cycle Applications

- Notes:
1. No purposely added lead. Fully EU Directive 2002/95/EC (RoHS) & 2011/65/EU (RoHS 2) compliant.
  2. See [http://www.diodes.com/quality/lead\\_free.html](http://www.diodes.com/quality/lead_free.html) for more information about Diodes Incorporated's definitions of Halogen- and Antimony-free, "Green" and Lead-free.
  3. Halogen- and Antimony-free "Green" products are defined as those which contain <900ppm bromine, <900ppm chlorine (<1500ppm total Br + Cl) and <1000ppm antimony compounds.

**Typical Applications Circuit**

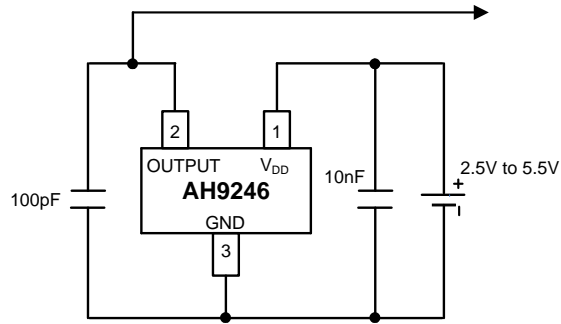

**Pin Descriptions**

Pin Number		Pin Name	Function
TO92S	SC59		
1	1	V <sub>DD</sub>	Power supply pin
2	3	GND	Ground pin
3	2	OUTPUT	Output pin

**Functional Block Diagram**

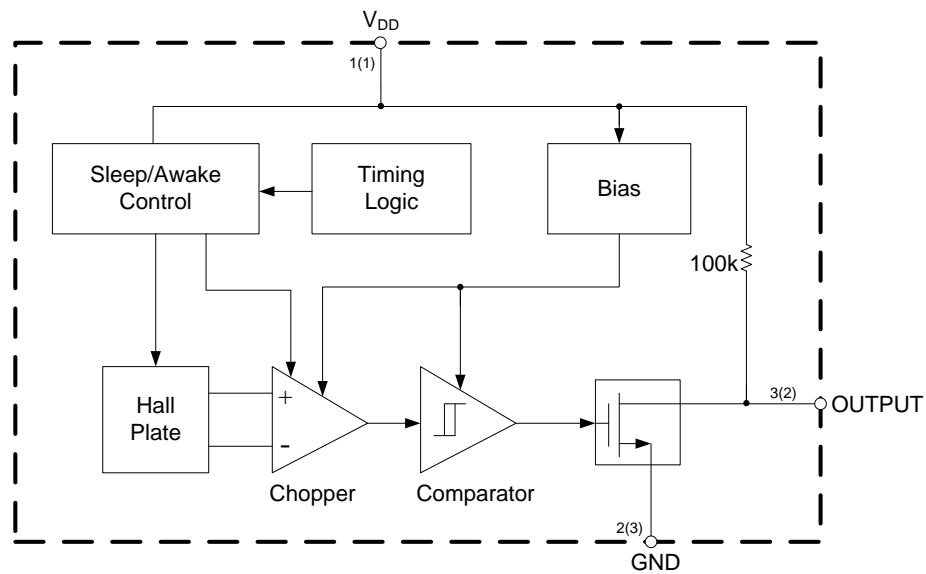

A (B)  
A for TO92S  
B for SC59

NEW PRODUCT

**Absolute Maximum Ratings** (Note 4) (@ $T_A = +25^\circ\text{C}$ , unless otherwise specified.)

Symbol	Parameter	Rating	Unit
$V_{DD}$	Supply Voltage (Note 5)	7	V
$I_{DD}$	Supply Current (Fault)	6	mA
$V_{OUT}$	Output Voltage	7	V
$I_{OUT}$	Output Current	2	mA
B	Magnetic Flux Density	Unlimited	Gauss
$P_D$	Power Dissipation	TO92S	230
		SC59	230
$T_{STG}$	Storage Temperature	-55 to +150	$^\circ\text{C}$
$T_J$	Junction Temperature	+150	$^\circ\text{C}$
–	ESD (Human Body Model) (Note 6)	5000	V
–	ESD (Machine Model) (Note 6)	400	V

- Notes:
- Stresses greater than the 'Absolute Maximum Ratings' specified above may cause permanent damage to the device. These are stress ratings only; functional operation of the device at these or any other conditions exceeding those indicated in this specification is not implied. Device reliability may be affected by exposure to absolute maximum rating conditions for extended periods of time.
  - The absolute maximum  $V_{DD}$  of 7V is a transient stress rating and is not meant as a functional operating condition. It is not recommended to operate the device at the absolute maximum rated conditions for any period of time.
  - Electronic semiconductor products are sensitive to Electro Static Discharge (ESD). Always observe Electro Static Discharge control procedures whenever handling semiconductor products.

**Recommended Operating Conditions**

Symbol	Characteristic	Conditions	Min	Max	Unit
$V_{DD}$	Supply Voltage	Operating	2.5	5.5	V
$T_A$	Operating Temperature Range	Operating	-40	+85	$^\circ\text{C}$

**Electrical Characteristics** (Note 7) (@ $T_A = +25^\circ\text{C}$ ,  $V_{DD} = 3\text{V}$ , unless otherwise specified.)

Symbol	Characteristic	Conditions	Min	Typ	Max	Unit
$V_{DD}$	Supply Voltage	Operating	2.5	3	5.5	V
$I_{DD\_AW}$	Supply Current During "Awake" Period	$T_A = -40$ to $+85^\circ\text{C}$ , $V_{DD} = 2.5\text{V}$ to $5.5\text{V}$	–	1.8	3	mA
$I_{DD\_SL}$	Supply Current During "Sleep" Period	$T_A = -40$ to $+85^\circ\text{C}$ , $V_{DD} = 2.5\text{V}$ to $5.5\text{V}$	–	4	10	$\mu\text{A}$
$I_{DD\_AVG}$	Average Supply Current	$T_A = -40$ to $+85^\circ\text{C}$ , $V_{DD} = 2.5\text{V}$ to $5.5\text{V}$	–	8	15	$\mu\text{A}$
$I_{OUT}$	Output Current	–	–	–	1.0	mA
$I_{OFF}$	Output Leakage Current	$V_{OUT} = 5.5\text{V}$ , Output off	–	<0.1	1	$\mu\text{A}$
$V_{OL}$	Output Low Voltage (On)	$I_{OUT} = 1.0\text{mA}$	–	–	0.4	V
$V_{OH}$	Output High Voltage (Off)	$I_{OUT} = -1.0\text{mA}$	$V_{DD}-0.2$	$V_{DD}-0.1$	–	V
$t_{AW}$	Awake Mode Time	Operating	–	150	–	$\mu\text{s}$
$t_{SL}$	Sleep Mode Time	Operating	–	100	–	ms
D	Duty Cycle	–	–	0.15	–	%
$f_C$	Chopper Frequency	–	–	15	–	kHz

- Note: 7. Parameters values over operating temperature range are not tested in production, they are guaranteed by design, process control and characterization. The magnetic characteristics may vary with supply voltage, operating temperature and after soldering.

**Electrical Characteristics** (Cont.) (@ $T_A = +25^\circ\text{C}$ ,  $V_{DD} = 3\text{V}$ , unless otherwise specified.)

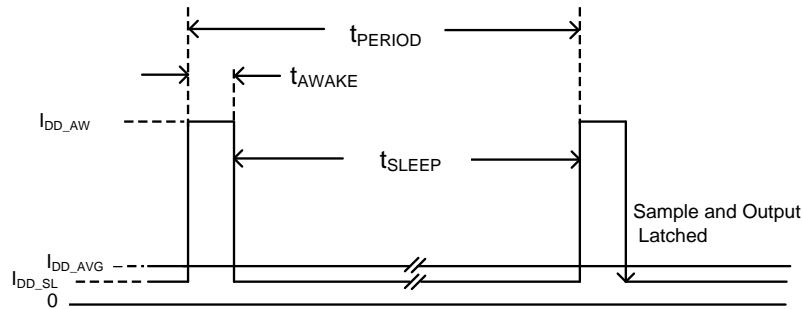

**Magnetic Characteristics** (Notes 8 & 9) (@ $T_A = -40^\circ\text{C}$  to  $+85^\circ\text{C}$ ,  $V_{DD} = 3\text{V}$ , unless otherwise specified.)

(1mT=10 Gauss)

Symbol	Parameter	Conditions	Min	Typ	Max	Unit
$B_{OPS}$ (South Pole to Part Marking Side)	Operating Point	$B > B_{OPS}, V_{OUT} = \text{Low}$ (output on)	9	18	27	Gauss
$B_{OPN}$ (North Pole to Part Marking Side)		$B > B_{OPN}, V_{OUT} = \text{Low}$ (output on)	-27	-18	-9	Gauss
$B_{RPS}$ (South Pole to Part Marking Side)	Releasing Point	$B < B_{RPS}, V_{OUT} = \text{High}$ (output off)	4	12	22	Gauss
$B_{RPN}$ (North Pole to Part Marking Side)		$B < B_{RPN}, V_{OUT} = \text{High}$ (output off)	-22	-12	-4	Gauss
$B_{HYS}$ (   $B_{OPX} - B_{RPX}$   )	Hysteresis	(Note 9)	-	6	-	Gauss

- Notes:
- Parameters values over operating temperature range are not tested in production, they are guaranteed by design, process control and characterization. The magnetic characteristics may vary with supply voltage, operating temperature and after soldering.
  - Maximum and minimum hysteresis is guaranteed by design and characterization.  
 $B_{OPX}$ =operating point (output turns on);  $B_{RPX}$ =releasing point (output turns off)

**Operating Characteristics**

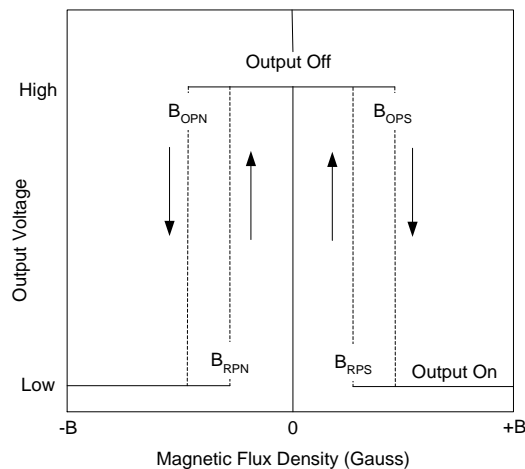

**Output Voltage vs. Magnetic Flux Density**

**Performance Characteristics**

NEW PRODUCT

**B<sub>OP</sub>/B<sub>RP</sub> vs. Supply Voltage**

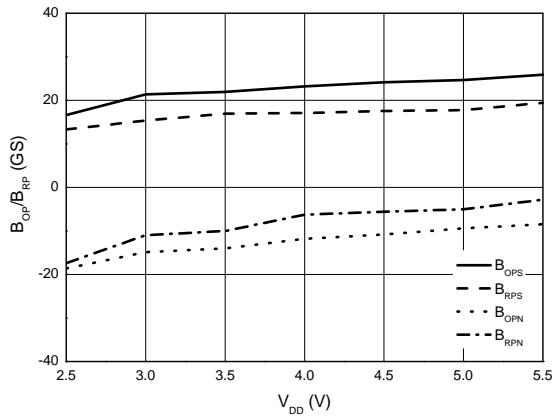

**B<sub>OP</sub>/B<sub>RP</sub> vs. Ambient Temperature**

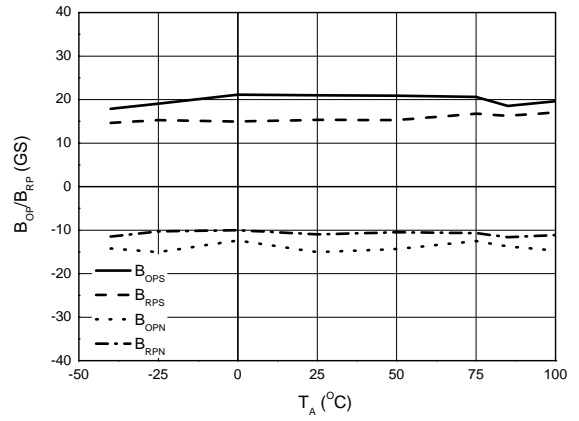

**Average Supply Current vs. Supply Voltage**

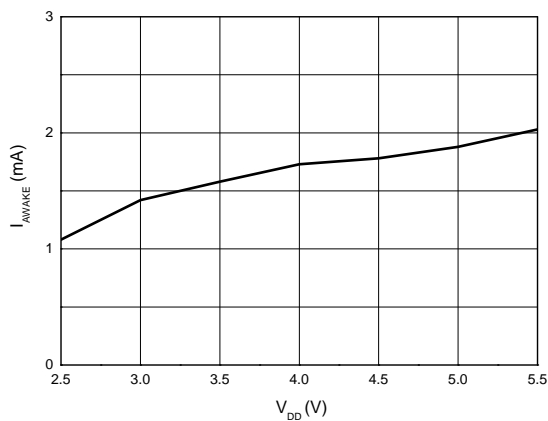

**Awake Mode Time vs. Supply Voltage**

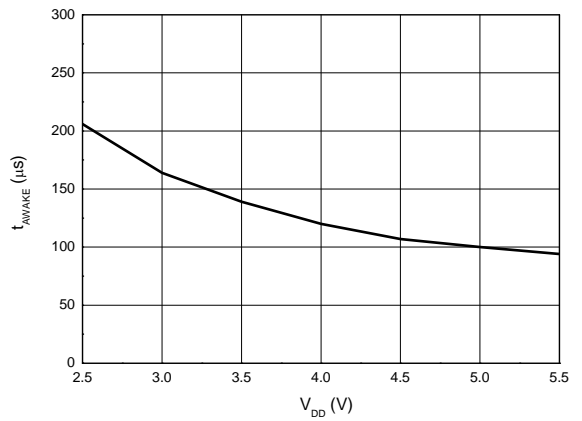

**Sleep Mode Time vs. Supply Voltage**

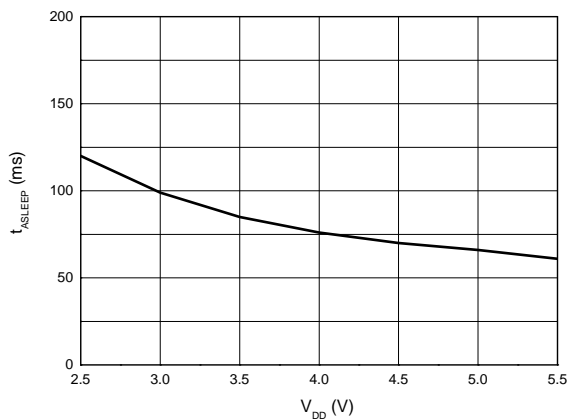

**Thermal Performance**

**Power Dissipation De-rating Curve**

(1) Package Types: SC59 and TO92S

T <sub>A</sub> (°C)	-40	0	25	50	60	70	80	85	90	100	110	120	130	140	150
P <sub>D</sub> (mW)	230	230	230	184	166	147	129	120	110	92	74	55	37	18	0

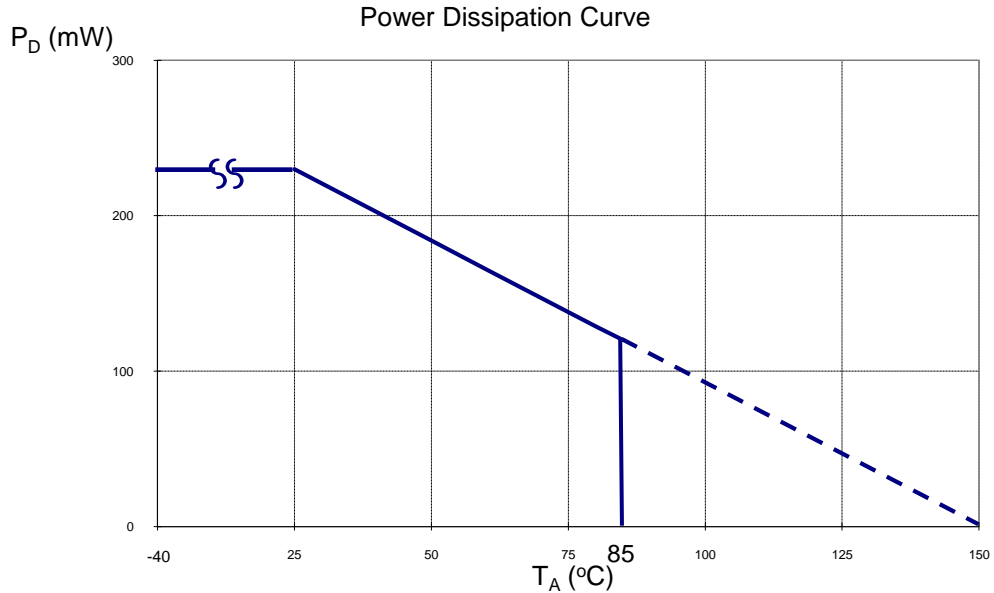

NEW PRODUCT

**Ordering Information**

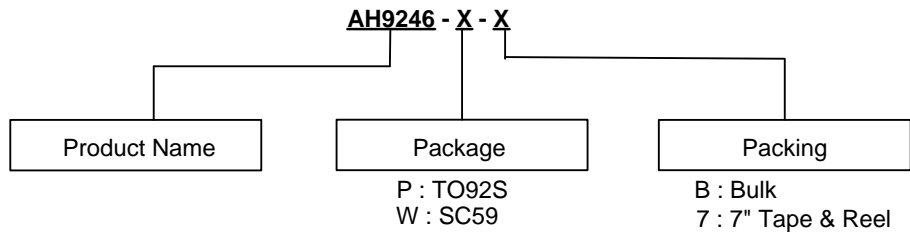

Device	Package Code	Packaging	Bulk	7" Tape and Reel
			Quantity	Quantity
AH9246-P-B	P	TO92S	1000/Bulk	NA
AH9246-W-7	W	SC59	NA	3000/Tape & Reel

**Marking Information**

(1) Package Type: TO92S

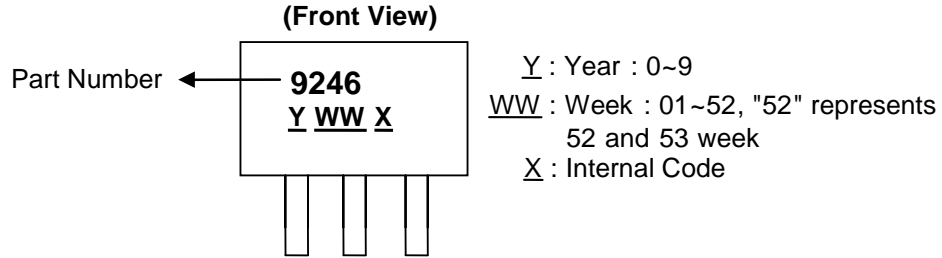

Part Number	Package	Identification Code
AH9246	TO92S	9246

(2) Package Type: SC59

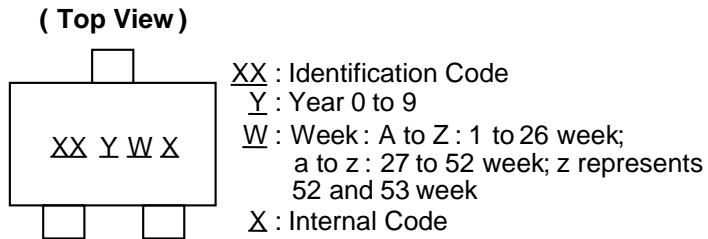

Part Number	Package	Identification Code
AH9246	SC59	H8

**Package Outline Dimensions** (All dimensions in mm.)

Please see AP02002 at <http://www.diodes.com/datasheets/ap02002.pdf> for the latest version.

(1) Package Type: TO92S(TYPE B)

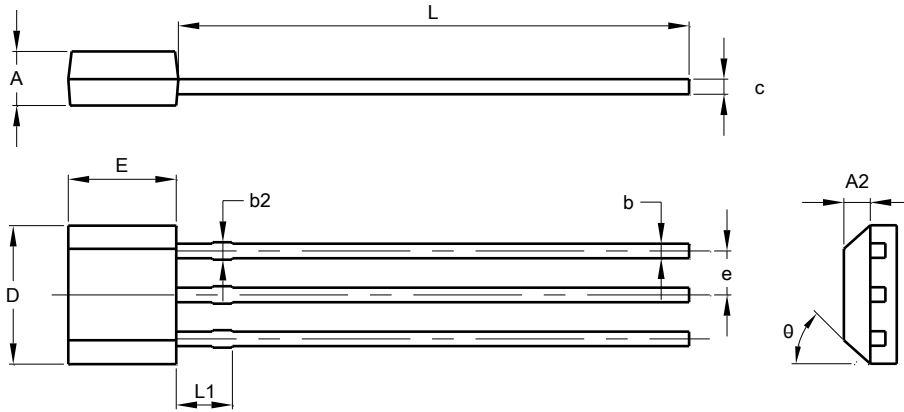

TO92S (TYPE B)			
Dim	Min	Max	Typ
A	1.420	1.620	-
A2	-	-	0.750
b	0.360	0.480	-
b2	0.380	0.550	-
c	0.360	0.510	-
D	3.850	4.150	-
E	2.900	3.310	-
e	-	-	1.270
L	14.000	15.500	-
L1	-	-	1.600
θ	44°	46°	-
All Dimensions in mm			

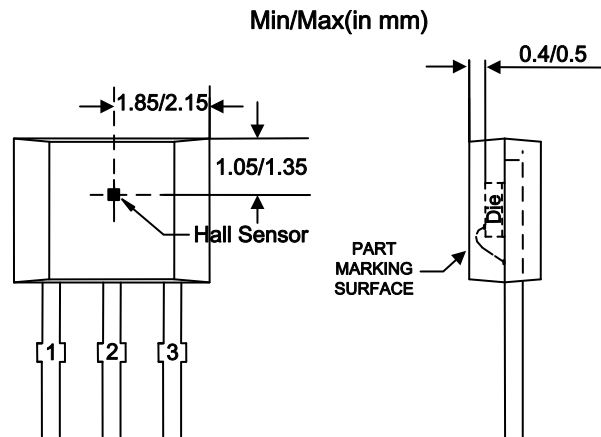

**Sensor Location**

NEW PRODUCT

**Package Outline Dimensions** (All dimensions in mm.) (Cont.)

Please see AP02002 at <http://www.diodes.com/datasheets/ap02002.pdf> for the latest version.

(2) Package Type: SC59

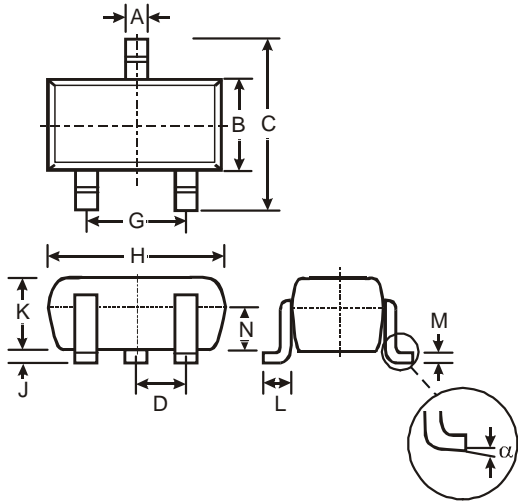

SC59			
Dim	Min	Max	Typ
A	0.35	0.50	0.38
B	1.50	1.70	1.60
C	2.70	3.00	2.80
D	-	-	0.95
G	-	-	1.90
H	2.90	3.10	3.00
J	0.013	0.10	0.05
K	1.00	1.30	1.10
L	0.35	0.55	0.40
M	0.10	0.20	0.15
N	0.70	0.80	0.75
α	0°	8°	-
All Dimensions in mm			

NEW PRODUCT

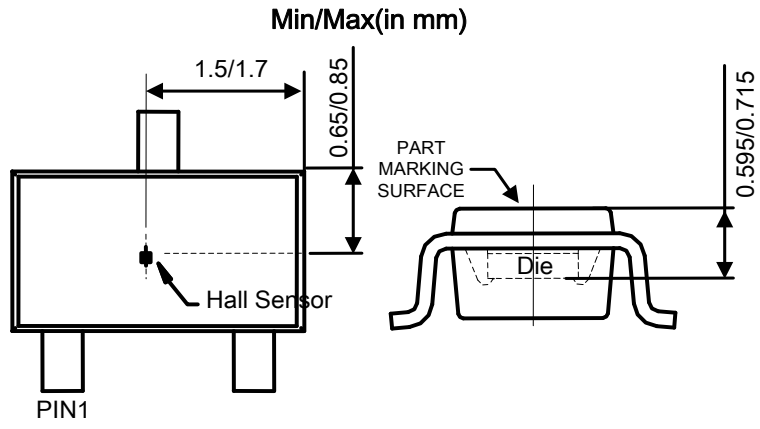

**Sensor Location**

## Suggested Pad Layout

Please see AP02001 at <http://www.diodes.com/datasheets/ap02001.pdf> for the latest version.

(1) Package Type: SC59

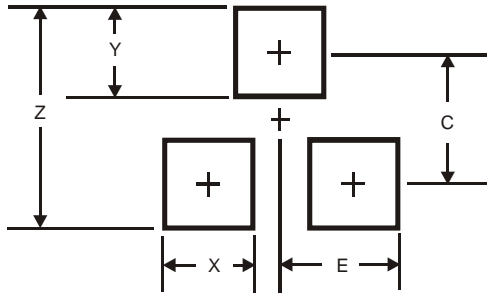

Dimensions	Value (in mm)
Z	3.4
X	0.8
Y	1.0
C	2.4
E	1.35

NEW PRODUCT

### IMPORTANT NOTICE

DIODES INCORPORATED MAKES NO WARRANTY OF ANY KIND, EXPRESS OR IMPLIED, WITH REGARDS TO THIS DOCUMENT, INCLUDING, BUT NOT LIMITED TO, THE IMPLIED WARRANTIES OF MERCHANTABILITY AND FITNESS FOR A PARTICULAR PURPOSE (AND THEIR EQUIVALENTS UNDER THE LAWS OF ANY JURISDICTION).

Diodes Incorporated and its subsidiaries reserve the right to make modifications, enhancements, improvements, corrections or other changes without further notice to this document and any product described herein. Diodes Incorporated does not assume any liability arising out of the application or use of this document or any product described herein; neither does Diodes Incorporated convey any license under its patent or trademark rights, nor the rights of others. Any Customer or user of this document or products described herein in such applications shall assume all risks of such use and will agree to hold Diodes Incorporated and all the companies whose products are represented on Diodes Incorporated website, harmless against all damages.

Diodes Incorporated does not warrant or accept any liability whatsoever in respect of any products purchased through unauthorized sales channel. Should Customers purchase or use Diodes Incorporated products for any unintended or unauthorized application, Customers shall indemnify and hold Diodes Incorporated and its representatives harmless against all claims, damages, expenses, and attorney fees arising out of, directly or indirectly, any claim of personal injury or death associated with such unintended or unauthorized application.

Products described herein may be covered by one or more United States, international or foreign patents pending. Product names and markings noted herein may also be covered by one or more United States, international or foreign trademarks.

This document is written in English but may be translated into multiple languages for reference. Only the English version of this document is the final and determinative format released by Diodes Incorporated.

### LIFE SUPPORT

Diodes Incorporated products are specifically not authorized for use as critical components in life support devices or systems without the express written approval of the Chief Executive Officer of Diodes Incorporated. As used herein:

A. Life support devices or systems are devices or systems which:

1. are intended to implant into the body, or
2. support or sustain life and whose failure to perform when properly used in accordance with instructions for use provided in the labeling can be reasonably expected to result in significant injury to the user.

B. A critical component is any component in a life support device or system whose failure to perform can be reasonably expected to cause the failure of the life support device or to affect its safety or effectiveness.



Customers represent that they have all necessary expertise in the safety and regulatory ramifications of their life support devices or systems, and acknowledge and agree that they are solely responsible for all legal, regulatory and safety-related requirements concerning their products and any use of Diodes Incorporated products in such safety-critical, life support devices or systems, notwithstanding any devices- or systems-related information or support that may be provided by Diodes Incorporated. Further, Customers must fully indemnify Diodes Incorporated and its representatives against any damages arising out of the use of Diodes Incorporated products in such safety-critical, life support devices or systems.

Copyright © 2015, Diodes Incorporated

[www.diodes.com](http://www.diodes.com)

## Looking for pricing, stock, or lifecycle information?

Click below to explore more details on WIN SOURCE:

-  [View AH9246-P-B on WIN SOURCE](#)
-  [Diodes Incorporated Information](#)

## Optimize Your Supply Chain with WIN SOURCE Solutions

-  Global Sourcing Solution
-  Obsolete Management
-  Cost Control Management
-  Shortage Management
-  Alternative Solution
-  Excess Inventory Management