



THE DATASHEET OF ADUM2400ARIZ



ADuM2400/ADuM2401/ADuM2402

Quad-Channel Digital Isolators

FEATURES

- ▶ Low power operation
 - ▶ 5 V operation
 - ▶ 1.0 mA per channel maximum @ 0 Mbps to 2 Mbps
 - ▶ 3.5 mA per channel maximum @ 10 Mbps
 - ▶ 31 mA per channel maximum @ 90 Mbps
 - ▶ 3 V operation
 - ▶ 0.7 mA per channel maximum @ 0 Mbps to 2 Mbps
 - ▶ 2.1 mA per channel maximum @ 10 Mbps
 - ▶ 20 mA per channel maximum @ 90 Mbps
- ▶ Bidirectional communication
- ▶ 3 V/5 V level translation
- ▶ High temperature operation: 105°C
- ▶ High data rate: dc to 90 Mbps (NRZ)
- ▶ Precise timing characteristics
 - ▶ 2 ns maximum pulse width distortion
 - ▶ 2 ns maximum channel-to-channel matching
- ▶ High common-mode transient immunity: >25 kV/μs
- ▶ Output enable function
- ▶ [16-lead SOIC wide body package version \(RW-16\)](#)
- ▶ [16-lead SOIC wide body enhanced creepage version \(RI-16\)](#)
- ▶ [Safety and regulatory approvals \(RI-16 package\)](#)
 - ▶ UL recognition: 5000 V rms for 1 minute per UL 1577
 - ▶ CSA Component Acceptance Notice 5A
 - ▶ IEC 60601-1: 250 V rms (reinforced)
 - ▶ IEC 60950-1: 400 V rms (reinforced)
 - ▶ VDE Certificate of Conformity
 - ▶ DIN V VDE V 0884-10 (VDE V 0884-10):2006-12
 - ▶ $V_{IORM} = 846$ V peak

APPLICATIONS

- ▶ General-purpose, high voltage, multichannel isolation
- ▶ Medical equipment
- ▶ Motor drives
- ▶ Power supplies

GENERAL DESCRIPTION

The ADuM2400/ADuM2401/ADuM2402¹ are 4-channel digital isolators based on Analog Devices, Inc., *iCoupler*[®] technology. Combining high speed CMOS and monolithic air core transformer technology, these isolation components provide outstanding performance characteristics that are superior to alternatives, such as optocoupler devices.

By avoiding the use of LEDs and photodiodes, *iCoupler* devices remove the design difficulties commonly associated with opto-couplers. The typical optocoupler concerns regarding uncertain current transfer ratios, nonlinear transfer functions, and temperature and lifetime effects are eliminated with the simple *iCoupler* digital interfaces and stable performance characteristics. Furthermore, *iCoupler* devices run at one-tenth to one-sixth the power of optocouplers at comparable signal data rates.

The ADuM2400/ADuM2401/ADuM2402 isolators provide four independent isolation channels in a variety of channel configurations and data rates (see the [Ordering Guide](#)). The ADuM2400/ADuM2401/ADuM2402 models operate with the supply voltage of either side ranging from 2.7 V to 5.5 V, providing compatibility with lower voltage systems as well as enabling a voltage translation functionality across the isolation barrier. In addition, the ADuM2400/ADuM2401/ADuM2402 provide low pulse width distortion (<2 ns for CRWZ grade) and tight channel-to-channel matching (<2 ns for CRWZ grade). The ADuM2400/ADuM2401/ADuM2402 isolators have a patented refresh feature that ensures dc correctness in the absence of input logic transitions and during power-up/power-down conditions.

¹ Protected by U.S. Patents 5,952,849; 6,873,065; and 7,075,329.

TABLE OF CONTENTS

Features.....	1	Maximum Continuous Working Voltage.....	15
Applications.....	1	ESD Caution.....	15
General Description.....	1	Truth Table.....	15
Functional Block Diagrams.....	3	Pin Configurations and Function Descriptions.....	16
Specifications.....	4	Typical Performance Characteristics.....	18
Electrical Characteristics—5 V Operation.....	4	Application Information.....	20
Electrical Characteristics—3 V Operation.....	6	PC Board Layout.....	20
Electrical Characteristics—Mixed 5 V/3 V or 3 V/5 V Operation.....	8	Propagation Delay-Related Parameters.....	20
Package Characteristics.....	12	DC Correctness and Magnetic Field Immunity.....	20
Regulatory Information.....	12	Power Consumption.....	21
Insulation and Safety-Related Specifications... DIN V VDE V 0884-10 (VDE V 0884-10)	12	Insulation Lifetime.....	21
Insulation Characteristics.....	13	Outline Dimensions.....	23
Recommended Operating Conditions.....	14	Ordering Guide.....	23
Absolute Maximum Ratings.....	15	Evaluation Boards.....	24

REVISION HISTORY**4/2023—Rev. F to Rev. G**

Changes to Logic High Output Voltages Parameter and Logic Low Output Voltages Parameter, Table 1.....	4
Changes to Logic High Output Voltages Parameter and Logic Low Output Voltages Parameter, Table 2.....	6
Changes to Logic High Output Voltages Parameter and Logic Low Output Voltages Parameter, Table 3.....	8
Updated Outline Dimensions.....	23
Changes to Ordering Guide.....	23
Added Evaluation Boards Section.....	24

FUNCTIONAL BLOCK DIAGRAMS

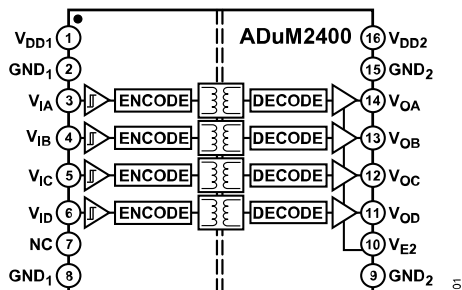

Figure 1. ADuM2400

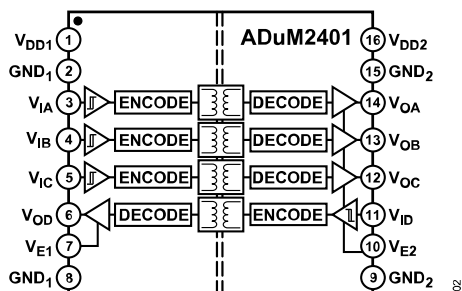

Figure 2. ADuM2401

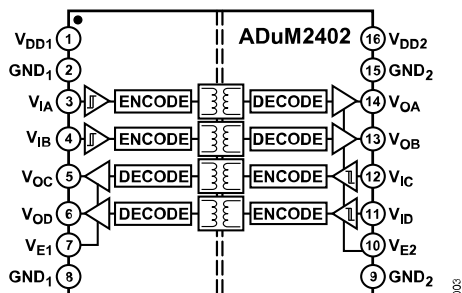

Figure 3. ADuM2402

SPECIFICATIONS

ELECTRICAL CHARACTERISTICS—5 V OPERATION

$4.5\text{ V} \leq V_{DD1} \leq 5.5\text{ V}$, $4.5\text{ V} \leq V_{DD2} \leq 5.5\text{ V}$. All minimum/maximum specifications apply over the entire recommended operation range, unless otherwise noted. All typical specifications are at $T_A = 25^\circ\text{C}$, $V_{DD1} = V_{DD2} = 5\text{ V}$. All voltages are relative to their respective ground.

Table 1.

Parameter	Symbol	Min	Typ	Max	Unit	Test Conditions
DC SPECIFICATIONS						
Input Supply Current per Channel, Quiescent	$I_{DD1(Q)}$		0.50	0.53	mA	
Output Supply Current per Channel, Quiescent	$I_{DD0(Q)}$		0.19	0.21	mA	
ADuM2400 Total Supply Current, Four Channels ¹						
DC to 2 Mbps						
V_{DD1} Supply Current	$I_{DD1(Q)}$		2.2	2.8	mA	DC to 1 MHz logic signal frequency
V_{DD2} Supply Current	$I_{DD2(Q)}$		0.9	1.4	mA	DC to 1 MHz logic signal frequency
10 Mbps (BRWZ and CRWZ Grades Only)						
V_{DD1} Supply Current	$I_{DD1(10)}$		8.6	10.6	mA	5 MHz logic signal frequency
V_{DD2} Supply Current	$I_{DD2(10)}$		2.6	3.5	mA	5 MHz logic signal frequency
90 Mbps (CRWZ Grade Only)						
V_{DD1} Supply Current	$I_{DD1(90)}$		70	100	mA	45 MHz logic signal frequency
V_{DD2} Supply Current	$I_{DD2(90)}$		18	25	mA	45 MHz logic signal frequency
ADuM2401 Total Supply Current, Four Channels ¹						
DC to 2 Mbps						
V_{DD1} Supply Current	$I_{DD1(Q)}$		1.8	2.4	mA	DC to 1 MHz logic signal frequency
V_{DD2} Supply Current	$I_{DD2(Q)}$		1.2	1.8	mA	DC to 1 MHz logic signal frequency
10 Mbps (BRWZ and CRWZ Grades Only)						
V_{DD1} Supply Current	$I_{DD1(10)}$		7.1	9.0	mA	5 MHz logic signal frequency
V_{DD2} Supply Current	$I_{DD2(10)}$		4.1	5.0	mA	5 MHz logic signal frequency
90 Mbps (CRWZ Grade Only)						
V_{DD1} Supply Current	$I_{DD1(90)}$		57	82	mA	45 MHz logic signal frequency
V_{DD2} Supply Current	$I_{DD2(90)}$		31	43	mA	45 MHz logic signal frequency
ADuM2402 Total Supply Current, Four Channels ¹						
DC to 2 Mbps						
V_{DD1} or V_{DD2} Supply Current	$I_{DD1(Q)}, I_{DD2(Q)}$		1.5	2.1	mA	DC to 1 MHz logic signal frequency
10 Mbps (BRWZ and CRWZ Grades Only)						
V_{DD1} or V_{DD2} Supply Current	$I_{DD1(10)}, I_{DD2(10)}$		5.6	7.0	mA	5 MHz logic signal frequency
90 Mbps (CRWZ Grade Only)						
V_{DD1} or V_{DD2} Supply Current	$I_{DD1(90)}, I_{DD2(90)}$		44	62	mA	45 MHz logic signal frequency
For All Models						
Input Currents	$I_{IA}, I_{IB}, I_{IC}, I_{ID}, I_{E1}, I_{E2}$	-10	+0.01	+10	μA	$0\text{ V} \leq V_{IA}, V_{IB}, V_{IC}, V_{ID} \leq V_{DD1}$ or V_{DD2} , $0\text{ V} \leq V_{E1}, V_{E2} \leq V_{DD1}$ or V_{DD2}
Logic High Input Threshold	V_{IH}, V_{EH}	2.0			V	
Logic Low Input Threshold	V_{IL}, V_{EL}			0.8	V	
Logic High Output Voltages	$V_{OAH}, V_{OBH}, V_{OCH}, V_{ODH}$	$(V_{DD1}$ or $V_{DD2}) - 0.1$	5.0		V	$I_{OX} = -20\ \mu\text{A}, V_{IX} = V_{IXH}$
		$(V_{DD1}$ or $V_{DD2}) - 0.4$	4.8		V	$I_{OX} = -3.2\ \text{mA}, V_{IX} = V_{IXH}$
Logic Low Output Voltages	$V_{OAL}, V_{OBL}, V_{OCL}, V_{ODL}$		0.0	0.1	V	$I_{OX} = 20\ \mu\text{A}, V_{IX} = V_{IXL}$
			0.04	0.1	V	$I_{OX} = 400\ \mu\text{A}, V_{IX} = V_{IXL}$
			0.2	0.4	V	$I_{OX} = 3.2\ \text{mA}, V_{IX} = V_{IXL}$
SWITCHING SPECIFICATIONS						
ADuM2400ARWZ/ADuM2401ARWZ/ADuM2402ARWZ						
Minimum Pulse Width ²	PW			1000	ns	$C_L = 15\ \text{pF}$, CMOS signal levels
Maximum Data Rate ³		1			Mbps	$C_L = 15\ \text{pF}$, CMOS signal levels

SPECIFICATIONS

Table 1. (Continued)

Parameter	Symbol	Min	Typ	Max	Unit	Test Conditions
Propagation Delay ⁴	t_{PHL}, t_{PLH}	50	65	100	ns	$C_L = 15$ pF, CMOS signal levels
Pulse Width Distortion, $ t_{PLH} - t_{PHL} $ ⁴	PWD			40	ns	$C_L = 15$ pF, CMOS signal levels
Propagation Delay Skew ⁵	t_{PSK}			50	ns	$C_L = 15$ pF, CMOS signal levels
Channel-to-Channel Matching ⁶	t_{PSKCD}/t_{PSKOD}			50	ns	$C_L = 15$ pF, CMOS signal levels
ADuM2400BRWZ/ADuM2401BRWZ/ADuM2402BRWZ						
Minimum Pulse Width ²	PW			100	ns	$C_L = 15$ pF, CMOS signal levels
Maximum Data Rate ³		10			Mbps	$C_L = 15$ pF, CMOS signal levels
Propagation Delay ⁴	t_{PHL}, t_{PLH}	20	32	50	ns	$C_L = 15$ pF, CMOS signal levels
Pulse Width Distortion, $ t_{PLH} - t_{PHL} $ ⁴	PWD			3	ns	$C_L = 15$ pF, CMOS signal levels
Change vs. Temperature			5		ps/°C	$C_L = 15$ pF, CMOS signal levels
Propagation Delay Skew ⁵	t_{PSK}			15	ns	$C_L = 15$ pF, CMOS signal levels
Channel-to-Channel Matching, Codirectional Channels ⁶	t_{PSKCD}			3	ns	$C_L = 15$ pF, CMOS signal levels
Channel-to-Channel Matching, Opposing-Directional Channels ⁶	t_{PSKOD}			6	ns	$C_L = 15$ pF, CMOS signal levels
ADuM2400CRWZ/ADuM2401CRWZ/ADuM2402CRWZ						
Minimum Pulse Width ²	PW		8.3	11.1	ns	$C_L = 15$ pF, CMOS signal levels
Maximum Data Rate ³		90	120		Mbps	$C_L = 15$ pF, CMOS signal levels
Propagation Delay ⁴	t_{PHL}, t_{PLH}	18	27	32	ns	$C_L = 15$ pF, CMOS signal levels
Pulse Width Distortion, $ t_{PLH} - t_{PHL} $ ⁴	PWD		0.5	2	ns	$C_L = 15$ pF, CMOS signal levels
Change vs. Temperature			3		ps/°C	$C_L = 15$ pF, CMOS signal levels
Propagation Delay Skew ⁵	t_{PSK}			10	ns	$C_L = 15$ pF, CMOS signal levels
Channel-to-Channel Matching, Codirectional Channels ⁶	t_{PSKCD}			2	ns	$C_L = 15$ pF, CMOS signal levels
Channel-to-Channel Matching, Opposing-Directional Channels ⁶	t_{PSKOD}			5	ns	$C_L = 15$ pF, CMOS signal levels
For All Models						
Output Disable Propagation Delay (High/Low to High Impedance)	t_{PHZ}, t_{PLH}		6	8	ns	$C_L = 15$ pF, CMOS signal levels
Output Enable Propagation Delay (High Impedance to High/Low)	t_{PZH}, t_{PZL}		6	8	ns	$C_L = 15$ pF, CMOS signal levels
Output Rise/Fall Time (10% to 90%)	t_R/t_F		2.5		ns	$C_L = 15$ pF, CMOS signal levels
Common-Mode Transient Immunity at Logic High Output ⁷	$ CM_H $	25	35		kV/ μ s	$V_{IX} = V_{DD1}$ or V_{DD2} , $V_{CM} = 1000$ V, transient magnitude = 800 V
Common-Mode Transient Immunity at Logic Low Output ⁷	$ CM_L $	25	35		kV/ μ s	$V_{IX} = 0$ V, $V_{CM} = 1000$ V, transient magnitude = 800 V
Refresh Rate	f_r		1.2		Mbps	
Input Dynamic Supply Current per Channel ⁸	$I_{DDI(D)}$		0.19		mA/Mbps	
Output Dynamic Supply Current per Channel ⁸	$I_{DDO(D)}$		0.05		mA/Mbps	

¹ Supply current values are for all four channels combined running at identical data rates. Output supply current values are specified with no output load present. The supply current associated with an individual channel operating at a given data rate can be calculated as described in the [Power Consumption](#) section. See [Figure 8](#) through [Figure 10](#) for information on per channel supply current as a function of data rate for unloaded and loaded conditions. See [Figure 11](#) through [Figure 15](#) for total V_{DD1} and V_{DD2} supply currents as a function of data rate for ADuM2400/ADuM2401/ADuM2402 channel configurations.

² The minimum pulse width is the shortest pulse width at which the specified pulse width distortion is guaranteed.

³ The maximum data rate is the fastest data rate at which the specified pulse width distortion is guaranteed.

⁴ t_{PHL} propagation delay is measured from the 50% level of the falling edge of the V_{IX} signal to the 50% level of the falling edge of the V_{OX} signal. t_{PLH} propagation delay is measured from the 50% level of the rising edge of the V_{IX} signal to the 50% level of the rising edge of the V_{OX} signal.

SPECIFICATIONS

- ⁵ t_{PSK} is the magnitude of the worst-case difference in t_{PHL} or t_{PLH} that is measured between units at the same operating temperature, supply voltages, and output load within the recommended operating conditions.
- ⁶ Codirectional channel-to-channel matching is the absolute value of the difference in propagation delays between any two channels with inputs on the same side of the isolation barrier. Opposing directional channel-to-channel matching is the absolute value of the difference in propagation delays between any two channels with inputs on opposing sides of the isolation barrier.
- ⁷ CM_H is the maximum common-mode voltage slew rate that can be sustained while maintaining $V_O > 0.8 V_{DD2}$. CM_L is the maximum common-mode voltage slew rate that can be sustained while maintaining $V_O < 0.8 V$. The common-mode voltage slew rates apply to both rising and falling common-mode voltage edges. The transient magnitude is the range over which the common mode is slewed.
- ⁸ Dynamic supply current is the incremental amount of supply current required for a 1 Mbps increase in signal data rate. See Figure 8 through Figure 10 for information on per channel supply current for unloaded and loaded conditions. See the Power Consumption section for guidance on calculating per channel supply current for a given data rate.

ELECTRICAL CHARACTERISTICS—3 V OPERATION

$2.7 V \leq V_{DD1} \leq 3.6 V$, $2.7 V \leq V_{DD2} \leq 3.6 V$. All minimum/maximum specifications apply over the entire recommended operation range, unless otherwise noted. All typical specifications are at $T_A = 25^\circ C$, $V_{DD1} = V_{DD2} = 3.0 V$. All voltages are relative to their respective ground.

Table 2.

Parameter	Symbol	Min	Typ	Max	Unit	Test Conditions
DC SPECIFICATIONS						
Input Supply Current per Channel, Quiescent	$I_{DD1(Q)}$		0.26	0.31	mA	
Output Supply Current per Channel, Quiescent	$I_{DDO(Q)}$		0.11	0.14	mA	
ADuM2400 Total Supply Current, Four Channels ¹						
DC to 2 Mbps						
V_{DD1} Supply Current	$I_{DD1(Q)}$		1.2	1.9	mA	DC to 1 MHz logic signal frequency
V_{DD2} Supply Current	$I_{DD2(Q)}$		0.5	0.9	mA	DC to 1 MHz logic signal frequency
10 Mbps (BRWZ and CRWZ Grades Only)						
V_{DD1} Supply Current	$I_{DD1(10)}$		4.5	6.5	mA	5 MHz logic signal frequency
V_{DD2} Supply Current	$I_{DD2(10)}$		1.4	2.0	mA	5 MHz logic signal frequency
90 Mbps (CRWZ Grade Only)						
V_{DD1} Supply Current	$I_{DD1(90)}$		37	65	mA	45 MHz logic signal frequency
V_{DD2} Supply Current	$I_{DD2(90)}$		11	15	mA	45 MHz logic signal frequency
ADuM2401 Total Supply Current, Four Channels ¹						
DC to 2 Mbps						
V_{DD1} Supply Current	$I_{DD1(Q)}$		1.0	1.6	mA	DC to 1 MHz logic signal frequency
V_{DD2} Supply Current	$I_{DD2(Q)}$		0.7	1.2	mA	DC to 1 MHz logic signal frequency
10 Mbps (BRWZ and CRWZ Grades Only)						
V_{DD1} Supply Current	$I_{DD1(10)}$		3.7	5.4	mA	5 MHz logic signal frequency
V_{DD2} Supply Current	$I_{DD2(10)}$		2.2	3.0	mA	5 MHz logic signal frequency
90 Mbps (CRWZ Grade Only)						
V_{DD1} Supply Current	$I_{DD1(90)}$		30	52	mA	45 MHz logic signal frequency
V_{DD2} Supply Current	$I_{DD2(90)}$		18	27	mA	45 MHz logic signal frequency
ADuM2402 Total Supply Current, Four Channels ¹						
DC to 2 Mbps						
V_{DD1} or V_{DD2} Supply Current	$I_{DD1(Q)}, I_{DD2(Q)}$		0.9	1.5	mA	DC to 1 MHz logic signal frequency
10 Mbps (BRWZ and CRWZ Grades Only)						
V_{DD1} or V_{DD2} Supply Current	$I_{DD1(10)}, I_{DD2(10)}$		3.0	4.2	mA	5 MHz logic signal frequency
90 Mbps (CRWZ Grade Only)						
V_{DD1} or V_{DD2} Supply Current	$I_{DD1(90)}, I_{DD2(90)}$		24	39	mA	45 MHz logic signal frequency

SPECIFICATIONS

Table 2. (Continued)

Parameter	Symbol	Min	Typ	Max	Unit	Test Conditions
For All Models						
Input Currents	$I_{IA}, I_{IB}, I_{IC}, I_{ID}, I_{E1}, I_{E2}$	-10	+0.01	+10	μA	$0 \text{ V} \leq V_{IA}, V_{IB}, V_{IC}, V_{ID} \leq V_{DD1} \text{ or } V_{DD2}$, $0 \text{ V} \leq V_{E1}, V_{E2} \leq V_{DD1} \text{ or } V_{DD2}$
Logic High Input Threshold	V_{IH}, V_{EH}	1.6			V	
Logic Low Input Threshold	V_{IL}, V_{EL}			0.4	V	
Logic High Output Voltages	$V_{OAH}, V_{OBH}, V_{OCH}, V_{ODH}$	$(V_{DD1} \text{ or } V_{DD2}) - 0.1$ $(V_{DD1} \text{ or } V_{DD2}) - 0.4$	3.0 2.8		V	$I_{OX} = -20 \mu\text{A}, V_{IX} = V_{IXH}$ $I_{OX} = -3.2 \text{ mA}, V_{IX} = V_{IXH}$
Logic Low Output Voltages	$V_{OAL}, V_{OBL}, V_{OCL}, V_{ODL}$		0.0 0.04 0.2	0.1 0.1 0.4	V	$I_{OX} = 20 \mu\text{A}, V_{IX} = V_{IXL}$ $I_{OX} = 400 \mu\text{A}, V_{IX} = V_{IXL}$ $I_{OX} = 3.2 \text{ mA}, V_{IX} = V_{IXL}$
SWITCHING SPECIFICATIONS						
ADuM2400ARWZ/ADuM2401ARWZ/ADuM2402ARWZ						
Minimum Pulse Width ²	PW			1000	ns	$C_L = 15 \text{ pF}$, CMOS signal levels
Maximum Data Rate ³		1			Mbps	$C_L = 15 \text{ pF}$, CMOS signal levels
Propagation Delay ⁴	t_{PHL}, t_{PLH}	50	75	100	ns	$C_L = 15 \text{ pF}$, CMOS signal levels
Pulse Width Distortion, $ t_{PLH} - t_{PHL} $ ⁴	PWD			40	ns	$C_L = 15 \text{ pF}$, CMOS signal levels
Propagation Delay Skew ⁵	t_{PSK}			50	ns	$C_L = 15 \text{ pF}$, CMOS signal levels
Channel-to-Channel Matching ⁶	t_{PSKCD}/t_{PSKOD}			50	ns	$C_L = 15 \text{ pF}$, CMOS signal levels
ADuM2400BRWZ/ADuM2401BRWZ/ADuM2402BRWZ						
Minimum Pulse Width ²	PW			100	ns	$C_L = 15 \text{ pF}$, CMOS signal levels
Maximum Data Rate ³		10			Mbps	$C_L = 15 \text{ pF}$, CMOS signal levels
Propagation Delay ⁴	t_{PHL}, t_{PLH}	20	38	50	ns	$C_L = 15 \text{ pF}$, CMOS signal levels
Pulse Width Distortion, $ t_{PLH} - t_{PHL} $ ⁴	PWD			3	ns	$C_L = 15 \text{ pF}$, CMOS signal levels
Change vs. Temperature			5		ps/°C	$C_L = 15 \text{ pF}$, CMOS signal levels
Propagation Delay Skew ⁵	t_{PSK}			22	ns	$C_L = 15 \text{ pF}$, CMOS signal levels
Channel-to-Channel Matching, Codirectional Channels ⁶	t_{PSKCD}			3	ns	$C_L = 15 \text{ pF}$, CMOS signal levels
Channel-to-Channel Matching, Opposing-Directional Channels ⁶	t_{PSKOD}			6	ns	$C_L = 15 \text{ pF}$, CMOS signal levels
ADuM2400CRWZ/ADuM2401CRWZ/ADuM2402CRWZ						
Minimum Pulse Width ²	PW		8.3	11.1	ns	$C_L = 15 \text{ pF}$, CMOS signal levels
Maximum Data Rate ³		90	120		Mbps	$C_L = 15 \text{ pF}$, CMOS signal levels
Propagation Delay ⁴	t_{PHL}, t_{PLH}	20	34	45	ns	$C_L = 15 \text{ pF}$, CMOS signal levels
Pulse Width Distortion, $ t_{PLH} - t_{PHL} $ ⁴	PWD		0.5	2	ns	$C_L = 15 \text{ pF}$, CMOS signal levels
Change vs. Temperature			3		ps/°C	$C_L = 15 \text{ pF}$, CMOS signal levels
Propagation Delay Skew ⁵	t_{PSK}			16	ns	$C_L = 15 \text{ pF}$, CMOS signal levels
Channel-to-Channel Matching, Codirectional Channels ⁶	t_{PSKCD}			2	ns	$C_L = 15 \text{ pF}$, CMOS signal levels
Channel-to-Channel Matching, Opposing-Directional Channels ⁶	t_{PSKOD}			5	ns	$C_L = 15 \text{ pF}$, CMOS signal levels
For All Models						
Output Disable Propagation Delay (High/Low to High Impedance)	t_{PHZ}, t_{PLH}		6	8	ns	$C_L = 15 \text{ pF}$, CMOS signal levels
Output Enable Propagation Delay (High Impedance to High/Low)	t_{PZH}, t_{PZL}		6	8	ns	$C_L = 15 \text{ pF}$, CMOS signal levels
Output Rise/Fall Time (10% to 90%)	t_R/t_F		3		ns	$C_L = 15 \text{ pF}$, CMOS signal levels
Common-Mode Transient Immunity at Logic High Output ⁷	$ CM_H $	25	35		kV/ μs	$V_{IX} = V_{DD1} \text{ or } V_{DD2}, V_{CM} = 1000 \text{ V}$, transient magnitude = 800 V
Common-Mode Transient Immunity at Logic Low Output ⁷	$ CM_L $	25	35		kV/ μs	$V_{IX} = 0 \text{ V}, V_{CM} = 1000 \text{ V}$, transient magnitude = 800 V

SPECIFICATIONS

Table 2. (Continued)

Parameter	Symbol	Min	Typ	Max	Unit	Test Conditions
Refresh Rate	f_r		1.1		Mbps	
Input Dynamic Supply Current per Channel ⁸	$I_{DD1(D)}$		0.10		mA/Mbps	
Output Dynamic Supply Current per Channel ⁸	$I_{DDO(D)}$		0.03		mA/Mbps	

¹ Supply current values are for all four channels combined running at identical data rates. Output supply current values are specified with no output load present. The supply current associated with an individual channel operating at a given data rate can be calculated as described in the [Power Consumption](#) section. See [Figure 8](#) through [Figure 10](#) for information on per channel supply current as a function of data rate for unloaded and loaded conditions. See [Figure 11](#) through [Figure 15](#) for total V_{DD1} and V_{DD2} supply currents as a function of data rate for ADuM2400/ADuM2401/ADuM2402 channel configurations.

² The minimum pulse width is the shortest pulse width at which the specified pulse width distortion is guaranteed.

³ The maximum data rate is the fastest data rate at which the specified pulse width distortion is guaranteed.

⁴ t_{PHL} propagation delay is measured from the 50% level of the falling edge of the V_{ix} signal to the 50% level of the falling edge of the V_{Ox} signal. t_{PLH} propagation delay is measured from the 50% level of the rising edge of the V_{ix} signal to the 50% level of the rising edge of the V_{Ox} signal.

⁵ t_{PSK} is the magnitude of the worst-case difference in t_{PHL} or t_{PLH} that is measured between units at the same operating temperature, supply voltages, and output load within the recommended operating conditions.

⁶ Codirectional channel-to-channel matching is the absolute value of the difference in propagation delays between any two channels with inputs on the same side of the isolation barrier. Opposing directional channel-to-channel matching is the absolute value of the difference in propagation delays between any two channels with inputs on opposing sides of the isolation barrier.

⁷ CM_H is the maximum common-mode voltage slew rate that can be sustained while maintaining $V_O > 0.8 V_{DD2}$. CM_L is the maximum common-mode voltage slew rate that can be sustained while maintaining $V_O < 0.8 V$. The common-mode voltage slew rates apply to both rising and falling common-mode voltage edges. The transient magnitude is the range over which the common mode is slewed.

⁸ Dynamic supply current is the incremental amount of supply current required for a 1 Mbps increase in signal data rate. See [Figure 8](#) through [Figure 10](#) for information on per channel supply current for unloaded and loaded conditions. See the [Power Consumption](#) section for guidance on calculating per channel supply current for a given data rate.

ELECTRICAL CHARACTERISTICS—MIXED 5 V/3 V OR 3 V/5 V OPERATION

5 V/3 V operation: $4.5 V \leq V_{DD1} \leq 5.5 V$, $2.7 V \leq V_{DD2} \leq 3.6 V$. 3 V/5 V operation: $2.7 V \leq V_{DD1} \leq 3.6 V$, $4.5 V \leq V_{DD2} \leq 5.5 V$. All minimum/maximum specifications apply over the entire recommended operation range, unless otherwise noted. All typical specifications are at $T_A = 25^\circ C$; $V_{DD1} = 3.0 V$, $V_{DD2} = 5 V$; or $V_{DD1} = 5 V$, $V_{DD2} = 3.0 V$. All voltages are relative to their respective ground.

Table 3.

Parameter	Symbol	Min	Typ	Max	Unit	Test Conditions
DC SPECIFICATIONS						
Input Supply Current per Channel, Quiescent	$I_{DD1(Q)}$					
5 V/3 V Operation			0.50	0.53	mA	
3 V/5 V Operation			0.26	0.31	mA	
Output Supply Current per Channel, Quiescent	$I_{DDO(Q)}$					
5 V/3 V Operation			0.11	0.14	mA	
3 V/5 V Operation			0.19	0.21	mA	
ADuM2400 Total Supply Current, Four Channels ¹						
DC to 2 Mbps						
V_{DD1} Supply Current	$I_{DD1(Q)}$					
5 V/3 V Operation			2.2	2.8	mA	DC to 1 MHz logic signal frequency
3 V/5 V Operation			1.2	1.9	mA	DC to 1 MHz logic signal frequency
V_{DD2} Supply Current	$I_{DD2(Q)}$					
5 V/3 V Operation			0.5	0.9	mA	DC to 1 MHz logic signal frequency
3 V/5 V Operation			0.9	1.4	mA	DC to 1 MHz logic signal frequency

SPECIFICATIONS

Table 3. (Continued)

Parameter	Symbol	Min	Typ	Max	Unit	Test Conditions
10 Mbps (BRWZ and CRWZ Grades Only)						
V _{DD1} Supply Current	I _{DD1} (10)					
5 V/3 V Operation			8.6	10.6	mA	5 MHz logic signal frequency
3 V/5 V Operation			4.5	6.5	mA	5 MHz logic signal frequency
V _{DD2} Supply Current	I _{DD2} (10)					
5 V/3 V Operation			1.4	2.0	mA	5 MHz logic signal frequency
3 V/5 V Operation			2.6	3.5	mA	5 MHz logic signal frequency
90 Mbps (CRWZ Grade Only)						
V _{DD1} Supply Current	I _{DD1} (90)					
5 V/3 V Operation			70	100	mA	45 MHz logic signal frequency
3 V/5 V Operation			37	65	mA	45 MHz logic signal frequency
V _{DD2} Supply Current	I _{DD2} (90)					
5 V/3 V Operation			11	15	mA	45 MHz logic signal frequency
3 V/5 V Operation			18	25	mA	45 MHz logic signal frequency
ADuM2401 Total Supply Current, Four Channels ¹						
DC to 2 Mbps						
V _{DD1} Supply Current	I _{DD1} (Q)					
5 V/3 V Operation			1.8	2.4	mA	DC to 1 MHz logic signal frequency
3 V/5 V Operation			1.0	1.6	mA	DC to 1 MHz logic signal frequency
V _{DD2} Supply Current	I _{DD2} (Q)					
5 V/3 V Operation			0.7	1.2	mA	DC to 1 MHz logic signal frequency
3 V/5 V Operation			1.2	1.8	mA	DC to 1 MHz logic signal frequency
10 Mbps (BRWZ and CRWZ Grades Only)						
V _{DD1} Supply Current	I _{DD1} (10)					
5 V/3 V Operation			7.1	9.0	mA	5 MHz logic signal frequency
3 V/5 V Operation			3.7	5.4	mA	5 MHz logic signal frequency
V _{DD2} Supply Current	I _{DD2} (10)					
5 V/3 V Operation			2.2	3.0	mA	5 MHz logic signal frequency
3 V/5 V Operation			4.1	5.0	mA	5 MHz logic signal frequency
90 Mbps (CRWZ Grade Only)						
V _{DD1} Supply Current	I _{DD1} (90)					
5 V/3 V Operation			57	82	mA	45 MHz logic signal frequency
3 V/5 V Operation			30	52	mA	45 MHz logic signal frequency
V _{DD2} Supply Current	I _{DD2} (90)					
5 V/3 V Operation			18	27	mA	45 MHz logic signal frequency
3 V/5 V Operation			31	43	mA	45 MHz logic signal frequency
ADuM2402 Total Supply Current, Four Channels ¹						
DC to 2 Mbps						
V _{DD1} Supply Current	I _{DD1} (Q)					
5 V/3 V Operation			1.5	2.1	mA	DC to 1 MHz logic signal frequency
3 V/5 V Operation			0.9	1.5	mA	DC to 1 MHz logic signal frequency
V _{DD2} Supply Current	I _{DD2} (Q)					
5 V/3 V Operation			0.9	1.5	mA	DC to 1 MHz logic signal frequency
3 V/5 V Operation			1.5	2.1	mA	DC to 1 MHz logic signal frequency
10 Mbps (BRWZ and CRWZ Grades Only)						
V _{DD1} Supply Current	I _{DD1} (10)					
5 V/3 V Operation			5.6	7.0	mA	5 MHz logic signal frequency
3 V/5 V Operation			3.0	4.2	mA	5 MHz logic signal frequency

SPECIFICATIONS

Table 3. (Continued)

Parameter	Symbol	Min	Typ	Max	Unit	Test Conditions
V_{DD2} Supply Current	I_{DD2} (10)					
5 V/3 V Operation			3.0	4.2	mA	5 MHz logic signal frequency
3 V/5 V Operation				5.6	7.0	mA
90 Mbps (CRWZ Grade Only)						
V_{DD1} Supply Current	I_{DD1} (90)					
5 V/3 V Operation			44	62	mA	45 MHz logic signal frequency
3 V/5 V Operation			24	39	mA	45 MHz logic signal frequency
V_{DD2} Supply Current	I_{DD2} (90)					
5 V/3 V Operation			24	39	mA	45 MHz logic signal frequency
3 V/5 V Operation			44	62	mA	45 MHz logic signal frequency
For All Models						
Input Currents	$I_{IA}, I_{IB}, I_{IC},$ I_{ID}, I_{E1}, I_{E2}	-10	+0.01	+10	μ A	$0\text{ V} \leq V_{IA}, V_{IB}, V_{IC}, V_{ID} \leq V_{DD1}$ or V_{DD2} , $0\text{ V} \leq V_{E1}, V_{E2} \leq V_{DD1}$ or V_{DD2}
Logic High Input Threshold	V_{IH}, V_{EH}					
5 V/3 V Operation		2.0			V	
3 V/5 V Operation		1.6			V	
Logic Low Input Threshold	V_{IL}, V_{EL}					
5 V/3 V Operation				0.8	V	
3 V/5 V Operation				0.4	V	
Logic High Output Voltages	$V_{OAH}, V_{OBH},$ V_{OCH}, V_{ODH}	$(V_{DD1}$ or $V_{DD2}) - 0.1$ $(V_{DD1}$ or $V_{DD2}) - 0.4$	$(V_{DD1}$ or $V_{DD2})$ $(V_{DD1}$ or $V_{DD2}) - 0.2$		V	$I_{OX} = -20\ \mu\text{A}, V_{IX} = V_{IXH}$ $I_{OX} = -3.2\ \text{mA}, V_{IX} = V_{IXH}$
Logic Low Output Voltages	$V_{OAL}, V_{OBL},$ V_{OCL}, V_{ODL}		0.0 0.04 0.2	0.1 0.1 0.4	V	$I_{OX} = 20\ \mu\text{A}, V_{IX} = V_{IXL}$ $I_{OX} = 400\ \mu\text{A}, V_{IX} = V_{IXL}$ $I_{OX} = 3.2\ \text{mA}, V_{IX} = V_{IXL}$
SWITCHING SPECIFICATIONS						
ADuM2400ARWZ/ADuM2401ARWZ/ ADuM2402ARWZ						
Minimum Pulse Width ²	PW			1000	ns	$C_L = 15\ \text{pF}$, CMOS signal levels
Maximum Data Rate ³		1			Mbps	$C_L = 15\ \text{pF}$, CMOS signal levels
Propagation Delay ⁴	t_{PHL}, t_{PLH}	50	70	100	ns	$C_L = 15\ \text{pF}$, CMOS signal levels
Pulse-Width Distortion, $ t_{PLH} - t_{PHL} $ ⁴	PWD			40	ns	$C_L = 15\ \text{pF}$, CMOS signal levels
Propagation Delay Skew ⁵	t_{PSK}			50	ns	$C_L = 15\ \text{pF}$, CMOS signal levels
Channel-to-Channel Matching ⁶	t_{PSKCD}/t_{PSKOD}			50	ns	$C_L = 15\ \text{pF}$, CMOS signal levels
ADuM2400BRWZ/ADuM2401BRWZ/ ADuM2402BRWZ						
Minimum Pulse Width ²	PW			100	ns	$C_L = 15\ \text{pF}$, CMOS signal levels
Maximum Data Rate ³		10			Mbps	$C_L = 15\ \text{pF}$, CMOS signal levels
Propagation Delay ⁴	t_{PHL}, t_{PLH}	15	35	50	ns	$C_L = 15\ \text{pF}$, CMOS signal levels
Pulse Width Distortion, $ t_{PLH} - t_{PHL} $ ⁴	PWD			3	ns	$C_L = 15\ \text{pF}$, CMOS signal levels
Change vs. Temperature			5		ps/°C	$C_L = 15\ \text{pF}$, CMOS signal levels
Propagation Delay Skew ⁵	t_{PSK}			22	ns	$C_L = 15\ \text{pF}$, CMOS signal levels
Channel-to-Channel Matching, Codirectional Channels ⁶	t_{PSKCD}			3	ns	$C_L = 15\ \text{pF}$, CMOS signal levels
Channel-to-Channel Matching, Opposing-Directional Channels ⁶	t_{PSKOD}			6	ns	$C_L = 15\ \text{pF}$, CMOS signal levels
ADuM2400CRWZ/ADuM2401CRWZ/ ADuM2402CRWZ						
Minimum Pulse Width ²	PW		8.3	11.1	ns	$C_L = 15\ \text{pF}$, CMOS signal levels
Maximum Data Rate ³		90	120		Mbps	$C_L = 15\ \text{pF}$, CMOS signal levels

SPECIFICATIONS

Table 3. (Continued)

Parameter	Symbol	Min	Typ	Max	Unit	Test Conditions
Propagation Delay ⁴	t_{PHL}, t_{PLH}	20	30	40	ns	$C_L = 15$ pF, CMOS signal levels
Pulse Width Distortion, $ t_{PLH} - t_{PHL} $ ⁴	PWD		0.5	2	ns	$C_L = 15$ pF, CMOS signal levels
Change vs. Temperature			3		ps/°C	$C_L = 15$ pF, CMOS signal levels
Propagation Delay Skew ⁵	t_{PSK}			14	ns	$C_L = 15$ pF, CMOS signal levels
Channel-to-Channel Matching, Codirectional Channels ⁶	t_{PSKCD}			2	ns	$C_L = 15$ pF, CMOS signal levels
Channel-to-Channel Matching, Opposing-Directional Channels ⁶	t_{PSKOD}			5	ns	$C_L = 15$ pF, CMOS signal levels
For All Models						
Output Disable Propagation Delay (High/Low to High Impedance)	t_{PHZ}, t_{PLH}		6	8	ns	$C_L = 15$ pF, CMOS signal levels
Output Enable Propagation Delay (High Impedance to High/Low)	t_{PZH}, t_{PZL}		6	8	ns	$C_L = 15$ pF, CMOS signal levels
Output Rise/Fall Time (10% to 90%)	t_R/t_F					$C_L = 15$ pF, CMOS signal levels
5 V/3 V Operation			3.0		ns	
3 V/5 V Operation			2.5		ns	
Common-Mode Transient Immunity at Logic High Output ⁷	$ CM_H $	25	35		kV/ μ s	$V_{IX} = V_{DD1}$ or V_{DD2} , $V_{CM} = 1000$ V, transient magnitude = 800 V
Common-Mode Transient Immunity at Logic Low Output ⁷	$ CM_L $	25	35		kV/ μ s	$V_{IX} = 0$ V, $V_{CM} = 1000$ V, transient magnitude = 800 V
Refresh Rate	f_r					
5 V/3 V Operation			1.2		Mbps	
3 V/5 V Operation			1.1		Mbps	
Input Dynamic Supply Current per Channel ⁸	$I_{DD1(D)}$					
5 V/3 V Operation			0.19		mA/Mbps	
3 V/5 V Operation			0.10		mA/Mbps	
Output Dynamic Supply Current per Channel ⁸	$I_{DDO(D)}$					
5 V/3 V Operation			0.03		mA/Mbps	
3 V/5 V Operation			0.05		mA/Mbps	

¹ Supply current values are for all four channels combined running at identical data rates. Output supply current values are specified with no output load present. The supply current associated with an individual channel operating at a given data rate can be calculated as described in the [Power Consumption](#) section. See [Figure 8](#) through [Figure 10](#) for information on per channel supply current as a function of data rate for unloaded and loaded conditions. See [Figure 11](#) through [Figure 15](#) for total V_{DD1} and V_{DD2} supply currents as a function of data rate for ADuM2400/ADuM2401/ADuM2402 channel configurations.

² The minimum pulse width is the shortest pulse width at which the specified pulse width distortion is guaranteed.

³ The maximum data rate is the fastest data rate at which the specified pulse width distortion is guaranteed.

⁴ t_{PHL} propagation delay is measured from the 50% level of the falling edge of the V_{IX} signal to the 50% level of the falling edge of the V_{OX} signal. t_{PLH} propagation delay is measured from the 50% level of the rising edge of the V_{IX} signal to the 50% level of the rising edge of the V_{OX} signal.

⁵ t_{PSK} is the magnitude of the worst-case difference in t_{PHL} or t_{PLH} that is measured between units at the same operating temperature, supply voltages, and output load within the recommended operating conditions.

⁶ Codirectional channel-to-channel matching is the absolute value of the difference in propagation delays between any two channels with inputs on the same side of the isolation barrier. Opposing directional channel-to-channel matching is the absolute value of the difference in propagation delays between any two channels with inputs on opposing sides of the isolation barrier.

⁷ CM_H is the maximum common-mode voltage slew rate that can be sustained while maintaining $V_O > 0.8 V_{DD2}$. CM_L is the maximum common-mode voltage slew rate that can be sustained while maintaining $V_O < 0.8$ V. The common-mode voltage slew rates apply to both rising and falling common-mode voltage edges. The transient magnitude is the range over which the common mode is slewed.

⁸ Dynamic supply current is the incremental amount of supply current required for a 1 Mbps increase in signal data rate. See [Figure 8](#) through [Figure 10](#) for information on per channel supply current for unloaded and loaded conditions. See the [Power Consumption](#) section for guidance on calculating per channel supply current for a given data rate.

SPECIFICATIONS

PACKAGE CHARACTERISTICS

Table 4.

Parameter	Symbol	Min	Typ	Max	Unit	Test Conditions
Resistance (Input to Output) ¹	R _{I-O}		10 ¹²		Ω	
Capacitance (Input to Output) ¹	C _{I-O}		2.2		pF	f = 1 MHz
Input Capacitance ²	C _I		4.0		pF	
IC Junction-to-Case Thermal Resistance, Side 1	θ _{JCI}		33		°C/W	Thermocouple located at center of package
IC Junction-to-Case Thermal Resistance, Side 2	θ _{JCO}		28		°C/W	underside

¹ Device considered a 2-terminal device: Pin 1, Pin 2, Pin 3, Pin 4, Pin 5, Pin 6, Pin 7, and Pin 8 shorted together and Pin 9, Pin 10, Pin 11, Pin 12, Pin 13, Pin 14, Pin 15, and Pin 16 shorted together.

² Input capacitance is from any input data pin to ground.

REGULATORY INFORMATION

The ADuM2400/ADuM2401/ADuM2402 are approved by the organizations listed in Table 5. Refer to Table 10 and the Insulation Lifetime section for details regarding recommended maximum working voltages for specific cross-isolation waveforms and insulation levels.

Table 5.

UL	CSA	CQC	VDE
Recognized Under UL 1577 Component Recognition Program ¹	Approved under CSA Component Acceptance Notice 5A	Approved under CQC11-471543-2012	Certified according to DIN V VDE V 0884-10 (VDE V 0884-10): 2006-12 ²
Single Protection 5000 V rms Isolation Voltage	Basic insulation per CSA 60950-1-07 and IEC 60950-1, 600 V rms (848 V peak) maximum working voltage RW-16 package: reinforced insulation per CSA 60950-1-07 and IEC 60950-1, 380 V rms (537 V peak) maximum working voltage; reinforced insulation per IEC 60601-1 125 V rms (176 V peak) maximum working voltage RI-16 package: reinforced insulation per CSA 60950-1-07 and IEC 60950-1, 400 V rms (565 V peak) maximum working voltage; reinforced insulation per IEC 60601-1 250 V rms (353 V peak) maximum working voltage	Basic insulation per GB4943.1-2011, 600 V rms(848 V peak) maximum working voltage, tropical climate, altitude ≤ 5000 m RW-16 package: reinforced insulation per GB4943.1-2011, 380 V rms (537 V peak) maximum working voltage, tropical climate, altitude ≤ 5000 m RI-16 package: reinforced insulation per 400 V rms (565 V peak) maximum working voltage, tropical climate, altitude ≤ 5000 m	Reinforced insulation, 846 V peak
File E214100	File 205078	File: CQC14001108690	File 2471900-4880-0001

¹ In accordance with UL 1577, each ADuM2400/ADuM2401/ADuM2402 is proof tested by applying an insulation test voltage ≥ 6000 V rms for 1 sec (current leakage detection limit = 10 μA).

² In accordance with DIN V VDE V 0884-10, each ADuM2400/ADuM2401/ADuM2402 is proof tested by applying an insulation test voltage ≥1590 V peak for 1 sec (partial discharge detection limit = 5 pC). The * marking branded on the component designates DIN V VDE V 0884-10 approval.

INSULATION AND SAFETY-RELATED SPECIFICATIONS

Table 6.

Parameter	Symbol	Value	Unit	Conditions
Rated Dielectric Insulation Voltage		5000	V rms	1-minute duration
Minimum External Air Gap	L(I01)	8.0 min	mm	Distance measured from input terminals to output terminals, shortest distance through air along the PCB mounting plane, as an aid to PC board layout
Minimum External Tracking (Creepage) RW-16 Package	L(I02)	7.7 min	mm	Measured from input terminals to output terminals, shortest distance path along body

SPECIFICATIONS

Table 6. (Continued)

Parameter	Symbol	Value	Unit	Conditions
Minimum External Tracking (Creepage) RI-16 Package	L(I02)	8.3 min	mm	Measured from input terminals to output terminals, shortest distance path along body
Minimum Internal Gap (Internal Clearance)		0.017 min	mm	Insulation distance through insulation
Tracking Resistance (Comparative Tracking Index)	CTI	>400	V	DIN IEC 112/VDE 0303 Part 1
Isolation Group		II		Material Group (DIN VDE 0110, 1/89, Table 1)

DIN V VDE V 0884-10 (VDE V 0884-10) INSULATION CHARACTERISTICS

These isolators are suitable for reinforced electrical isolation only within the safety limit data. Maintenance of the safety data is ensured by means of protective circuits.

Note that the * marking on packages denotes DIN V VDE V 0884-10 approval for 846 V peak working voltage.

Table 7.

Description	Conditions	Symbol	Characteristic	Unit
Installation Classification per DIN VDE 0110			I to IV	
For Rated Mains Voltage ≤ 300 V rms			I to II	
For Rated Mains Voltage ≤ 450 V rms			I to II	
For Rated Mains Voltage ≤ 600 V rms			40/105/21	
Climatic Classification			2	
Pollution Degree (DIN VDE 0110, Table 1)				
Maximum Working Insulation Voltage		V_{IORM}	846	V peak
Input-to-Output Test Voltage, Method b1	$V_{IORM} \times 1.875 = V_{PR}$, 100% production test, $t_m = 1$ sec, partial discharge < 5 pC	V_{PR}	1590	V peak
Input-to-Output Test Voltage, Method a		V_{PR}		
After Environmental Tests Subgroup 1	$V_{IORM} \times 1.6 = V_{PR}$, $t_m = 60$ sec, partial discharge < 5 pC		1375	V peak
After Input and/or Safety Test Subgroup 2 and Subgroup 3	$V_{IORM} \times 1.2 = V_{PR}$, $t_m = 60$ sec, partial discharge < 5 pC		1018	V peak
Highest Allowable Overvoltage	Transient overvoltage, $t_{TR} = 10$ seconds	V_{TR}	6000	V peak
Safety-Limiting Values	Maximum value allowed in the event of a failure; see Figure 4			
Case Temperature		T_S	150	°C
Side 1 Current		I_{S1}	265	mA
Side 2 Current		I_{S2}	335	mA
Insulation Resistance at T_S	$V_{IO} = 500$ V	R_S	>10 ⁹	Ω



Figure 4. Thermal Derating Curve, Dependence of Safety-Limiting Values with Case Temperature per DIN V VDE V 0884-10

SPECIFICATIONS**RECOMMENDED OPERATING CONDITIONS****Table 8.**

Parameter	Rating
Operating Temperature (T_A)	-40°C to +105°C
Supply Voltages ¹ (V_{DD1} , V_{DD2})	2.7 V to 5.5 V
Input Signal Rise and Fall Times	1.0 ms

¹ All voltages are relative to their respective ground.

ABSOLUTE MAXIMUM RATINGS

Table 9.

Parameter	Rating
Storage Temperature Range (T_{ST})	-65°C to +150°C
Ambient Operating Temperature Range (T_A)	-40°C to +105°C
Supply Voltage Range (V_{DD1} , V_{DD2}) ¹	-0.5 V to +7.0 V
Input Voltage Range (V_{IA} , V_{IB} , V_{IC} , V_{ID} , V_{E1} , V_{E2}) ^{1, 2}	-0.5 V to $V_{DD1} + 0.5$ V
Output Voltage Range (V_{OA} , V_{OB} , V_{OC} , V_{OD}) ^{1, 2}	-0.5 V to $V_{DD0} + 0.5$ V
Average Output Current Per Pin ³	
Side 1 (I_{O1})	-18 mA to +18 mA
Side 2 (I_{O2})	-22 mA to +22 mA
Common-Mode Transients ⁴	-100 kV/ μ s to +100 kV/ μ s

¹ All voltages are relative to their respective ground.

² V_{DD1} and V_{DD0} refer to the supply voltages on the input and output sides of a given channel, respectively. See the [PC Board Layout](#) section.

³ See [Figure 4](#) for maximum rated current values for various temperatures.

⁴ Refers to common-mode transients across the isolation barrier. Common-mode transients exceeding the Absolute Maximum Rating can cause latch-up or permanent damage.

Stresses at or above those listed under Absolute Maximum Ratings may cause permanent damage to the product. This is a stress rating only; functional operation of the product at these or any other conditions above those indicated in the operational section of this specification is not implied. Operation beyond the maximum operating conditions for extended periods may affect product reliability.

TRUTH TABLE

Table 11. Truth Table (Positive Logic)

V_{IX} Input ¹	V_{EX} Input	V_{DD1} State ¹	V_{DD0} State ¹	V_{OX} Output ¹	Notes
H	H or NC	Powered	Powered	H	
L	H or NC	Powered	Powered	L	
X	L	Powered	Powered	Z	
X	H or NC	Unpowered	Powered	H	Outputs return to input state within 1 μ s of V_{DD1} power restoration.
X	L	Unpowered	Powered	Z	
X	X	Powered	Unpowered	Indeterminate	Outputs return to input state within 1 μ s of V_{DD0} power restoration if V_{EX} state is H or NC. Outputs return to high impedance state within 8 ns of V_{DD0} power restoration if V_{EX} state is L.

¹ V_{IX} and V_{OX} refer to the input and output signals of a given channel (A, B, C, or D). V_{EX} refers to the output enable signal on the same side as the V_{OX} outputs. V_{DD1} and V_{DD0} refer to the supply voltages on the input and output sides of the given channel, respectively.

MAXIMUM CONTINUOUS WORKING VOLTAGE

Table 10. Maximum Continuous Working Voltage

Parameter ¹	Max	Unit	Constraint
AC Voltage, Bipolar Waveform	565	V peak	50-year minimum lifetime
AC Voltage, Unipolar Waveform	846	V peak	Maximum approved working voltage per IEC 60950-1 and VDE V 0884-10
Reinforced Insulation			
DC Voltage	846	V peak	Maximum approved working voltage per IEC 60950-1 and VDE V 0884-10
Reinforced Insulation			

¹ Refers to continuous voltage magnitude imposed across the isolation barrier. See the [Insulation Lifetime](#) section for more details.

ESD CAUTION



ESD (electrostatic discharge) sensitive device. Charged devices and circuit boards can discharge without detection. Although this product features patented or proprietary protection circuitry, damage may occur on devices subjected to high energy ESD. Therefore, proper ESD precautions should be taken to avoid performance degradation or loss of functionality.

PIN CONFIGURATIONS AND FUNCTION DESCRIPTIONS

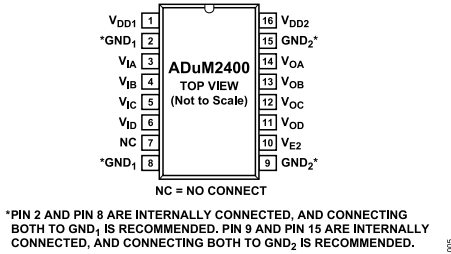

Figure 5. ADuM2400 Pin Configuration

Table 12. ADuM2400 Pin Function Descriptions

Pin No.	Mnemonic	Description
1	V _{DD1}	Supply Voltage for Isolator Side 1, 2.7 V to 5.5 V.
2	GND ₁	Ground 1. Ground reference for Isolator Side 1.
3	V _{IA}	Logic Input A.
4	V _{IB}	Logic Input B.
5	V _{IC}	Logic Input C.
6	V _{ID}	Logic Input D.
7	NC	No Connect.
8	GND ₁	Ground 1. Ground reference for Isolator Side 1.
9	GND ₂	Ground 2. Ground reference for Isolator Side 2.
10	V _{E2}	Output Enable 2. Active high logic input. V _{OA} , V _{OB} , V _{OC} , and V _{OD} outputs are enabled when V _{E2} is high or disconnected. V _{OA} , V _{OB} , V _{OC} , and V _{OD} outputs are disabled when V _{E2} is low. In noisy environments, connecting V _{E2} to an external logic high or low is recommended.
11	V _{OD}	Logic Output D.
12	V _{OC}	Logic Output C.
13	V _{OB}	Logic Output B.
14	V _{OA}	Logic Output A.
15	GND ₂	Ground 2. Ground reference for Isolator Side 2.
16	V _{DD2}	Supply Voltage for Isolator Side 2, 2.7 V to 5.5 V.

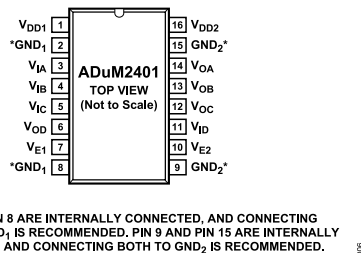

Figure 6. ADuM2401 Pin Configuration

Table 13. ADuM2401 Pin Function Descriptions

Pin No.	Mnemonic	Description
1	V _{DD1}	Supply Voltage for Isolator Side 1, 2.7 V to 5.5 V.
2	GND ₁	Ground 1. Ground reference for Isolator Side 1.
3	V _{IA}	Logic Input A.
4	V _{IB}	Logic Input B.
5	V _{IC}	Logic Input C.
6	V _{OD}	Logic Output D.
7	V _{E1}	Output Enable 1. Active high logic input. V _{OD} output is enabled when V _{E1} is high or disconnected. V _{OD} is disabled when V _{E1} is low. In noisy environments, connecting V _{E1} to an external logic high or low is recommended.
8	GND ₁	Ground 1. Ground reference for Isolator Side 1.

PIN CONFIGURATIONS AND FUNCTION DESCRIPTIONS

Table 13. ADuM2401 Pin Function Descriptions (Continued)

Pin No.	Mnemonic	Description
9	GND ₂	Ground 2. Ground reference for Isolator Side 2.
10	V _{E2}	Output Enable 2. Active high logic input. V _{OA} , V _{OB} , and V _{OC} outputs are enabled when V _{E2} is high or disconnected. V _{OA} , V _{OB} , and V _{OC} outputs are disabled when V _{E2} is low. In noisy environments, connecting V _{E2} to an external logic high or low is recommended.
11	V _{ID}	Logic Input D.
12	V _{OC}	Logic Output C.
13	V _{OB}	Logic Output B.
14	V _{OA}	Logic Output A.
15	GND ₂	Ground 2. Ground reference for Isolator Side 2.
16	V _{DD2}	Supply Voltage for Isolator Side 2, 2.7 V to 5.5 V.

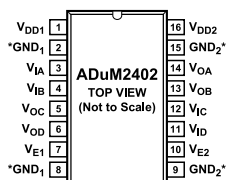

*PIN 2 AND PIN 8 ARE INTERNALLY CONNECTED, AND CONNECTING BOTH TO GND₁ IS RECOMMENDED. PIN 9 AND PIN 15 ARE INTERNALLY CONNECTED, AND CONNECTING BOTH TO GND₂ IS RECOMMENDED.

Figure 7. ADuM2402 Pin Configuration

Table 14. ADuM2402 Pin Function Descriptions

Pin No.	Mnemonic	Description
1	V _{DD1}	Supply Voltage for Isolator Side 1, 2.7 V to 5.5 V.
2	GND ₁	Ground 1. Ground reference for Isolator Side 1.
3	V _{IA}	Logic Input A.
4	V _{IB}	Logic Input B.
5	V _{OC}	Logic Output C.
6	V _{OD}	Logic Output D.
7	V _{E1}	Output Enable 1. Active high logic input. V _{OC} and V _{OD} outputs are enabled when V _{E1} is high or disconnected. V _{OC} and V _{OD} outputs are disabled when V _{E1} is low. In noisy environments, connecting V _{E1} to an external logic high or low is recommended.
8	GND ₁	Ground 1. Ground reference for Isolator Side 1.
9	GND ₂	Ground 2. Ground reference for Isolator Side 2.
10	V _{E2}	Output Enable 2. Active high logic input. V _{OA} and V _{OB} outputs are enabled when V _{E2} is high or disconnected. V _{OA} and V _{OB} outputs are disabled when V _{E2} is low. In noisy environments, connecting V _{E2} to an external logic high or low is recommended.
11	V _{ID}	Logic Input D.
12	V _{IC}	Logic Input C.
13	V _{OB}	Logic Output B.
14	V _{OA}	Logic Output A.
15	GND ₂	Ground 2. Ground reference for Isolator Side 2.
16	V _{DD2}	Supply Voltage for Isolator Side 2, 2.7 V to 5.5 V.

TYPICAL PERFORMANCE CHARACTERISTICS



Figure 8. Typical Input Supply Current per Channel vs. Data Rate for 5 V and 3 V Operation (No Output Load)



Figure 11. Typical ADuM2400 V_{DD1} Supply Current vs. Data Rate for 5 V and 3 V Operation

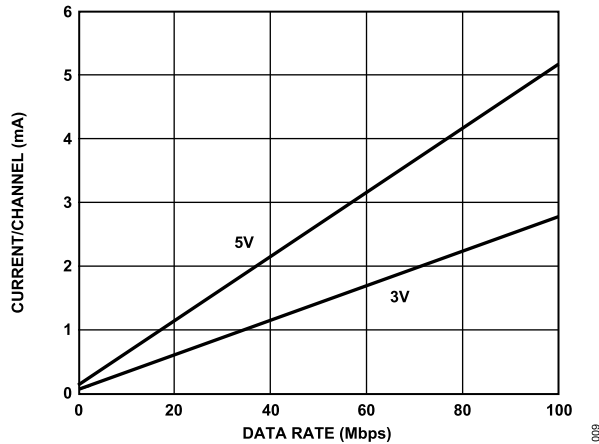

Figure 9. Typical Output Supply Current per Channel vs. Data Rate for 5 V and 3 V Operation (No Output Load)

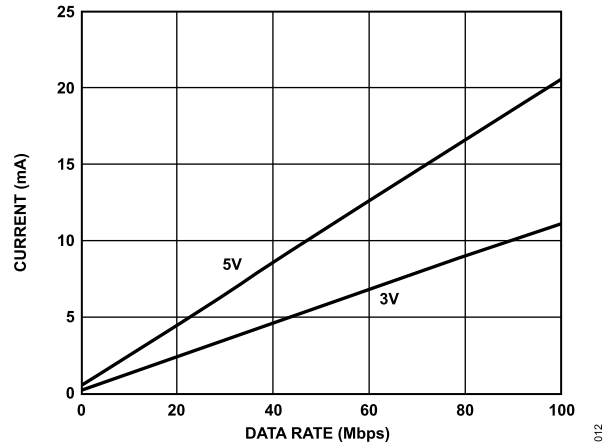

Figure 12. Typical ADuM2400 V_{DD2} Supply Current vs. Data Rate for 5 V and 3 V Operation

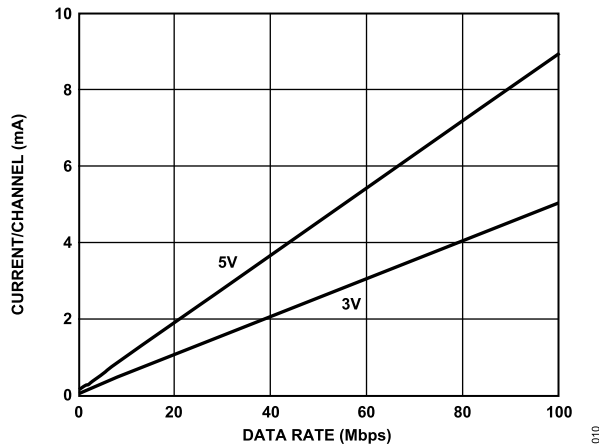

Figure 10. Typical Output Supply Current per Channel vs. Data Rate for 5 V and 3 V Operation (15 pF Output Load)

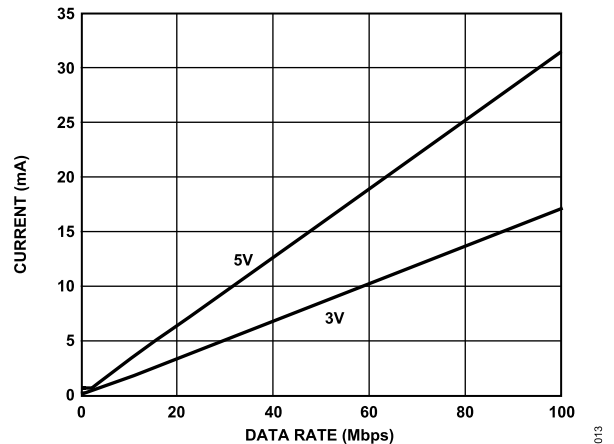

Figure 13. Typical ADuM2401 V_{DD1} Supply Current vs. Data Rate for 5 V and 3 V Operation

TYPICAL PERFORMANCE CHARACTERISTICS



Figure 14. Typical ADuM2401 V_{DD2} Supply Current vs. Data Rate for 5 V and 3 V Operation

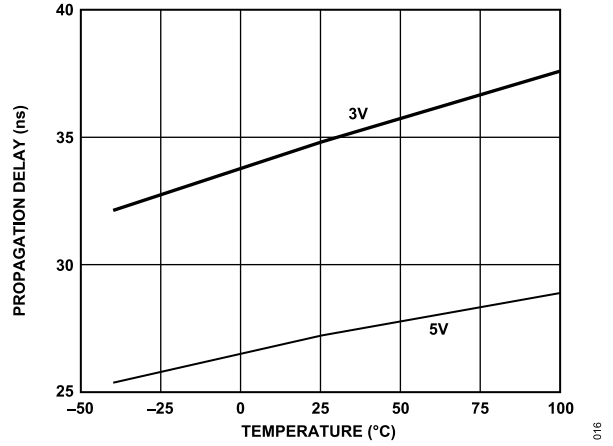

Figure 16. Propagation Delay vs. Temperature, C Grade



Figure 15. Typical ADuM2402 V_{DD1} or V_{DD2} Supply Current vs. Data Rate for 5 V and 3 V Operation

APPLICATION INFORMATION

PC BOARD LAYOUT

The ADuM2400/ADuM2401/ADuM2402 digital isolator requires no external interface circuitry for the logic interfaces. Power supply bypassing is strongly recommended at the input and output supply pins (see Figure 17). Bypass capacitors are most conveniently connected between Pin 1 and Pin 2 for V_{DD1} and between Pin 15 and Pin 16 for V_{DD2}. The capacitor value should be between 0.01 μF and 0.1 μF. The total lead length between both ends of the capacitor and the input power supply pin should not exceed 20 mm. Bypassing between Pin 1 and Pin 8 and between Pin 9 and Pin 16 should be considered unless the ground pair on each package side are connected close to the package.

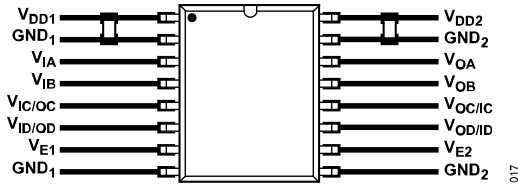

Figure 17. Recommended Printed Circuit Board Layout

In applications involving high common-mode transients, ensure that board coupling across the isolation barrier is minimized. Furthermore, the board layout should be designed such that any coupling that does occur equally affects all pins on a given component side. Failure to ensure this could cause voltage differentials between pins exceeding the device's Absolute Maximum Ratings, thereby leading to latch-up or permanent damage.

See the AN-1109 Application Note for board layout guidelines.

PROPAGATION DELAY-RELATED PARAMETERS

Propagation delay is a parameter that describes the length of time it takes for a logic signal to propagate through a component. The propagation delay to a logic low output can differ from the propagation delay to logic high.

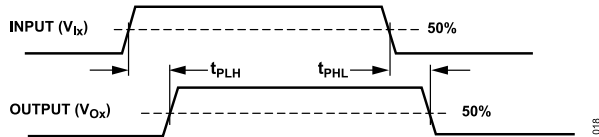

Figure 18. Propagation Delay Parameters

Pulse width distortion is the maximum difference between these two propagation delay values and is an indication of how accurately the input signal's timing is preserved.

Channel-to-channel matching refers to the maximum amount the propagation delay differs among channels within a single ADuM2400/ADuM2401/ADuM2402 component.

Propagation delay skew refers to the maximum amount the propagation delay differs among multiple ADuM2400/ADuM2401/ADuM2402 components operated under the same conditions.

DC CORRECTNESS AND MAGNETIC FIELD IMMUNITY

Positive and negative logic transitions at the isolator input cause narrow (~1 ns) pulses to be sent via the transformer to the decoder. The decoder is bistable and is therefore either set or reset by the pulses, indicating input logic transitions. In the absence of logic transitions at the input for more than ~1 μs, a periodic set of refresh pulses indicative of the correct input state are sent to ensure dc correctness at the output. If the decoder receives no internal pulses for more than approximately 5 μs, the input side is assumed to be without power or nonfunctional; in which case, the isolator output is forced to a default state (see Table 11) by the watchdog timer circuit.

The limitation on the ADuM2400/ADuM2401/ADuM2402 magnetic field immunity is set by the condition in which induced voltage in the transformer's receiving coil is large enough to either falsely set or reset the decoder. The following analysis defines the conditions under which this can occur. The 3 V operating condition of the ADuM2400/ADuM2401/ADuM2402 is examined because it represents the most susceptible mode of operation.

The pulses at the transformer output have an amplitude greater than 1.0 V. The decoder has a sensing threshold at about 0.5 V, therefore establishing a 0.5 V margin in which induced voltages can be tolerated. The voltage induced across the receiving coil is given by

$$V = (-d\beta/dt)\Sigma\pi r_n^2; n = 1, 2, \dots, N$$

where:

β is the magnetic flux density (gauss).

N is the number of turns in the receiving coil.

r_n is the radius of the n^{th} turn in the receiving coil (cm).

Given the geometry of the receiving coil in the ADuM2400/ADuM2401/ADuM2402 and an imposed requirement that the induced voltage be at most 50% of the 0.5 V margin at the decoder, a maximum allowable magnetic field is calculated as shown in Figure 19.



Figure 19. Maximum Allowable External Magnetic Flux Density

APPLICATION INFORMATION

For example, at a magnetic field frequency of 1 MHz, the maximum allowable magnetic field of 0.2 kgauss induces a voltage of 0.25 V at the receiving coil. This is about 50% of the sensing threshold and does not cause a faulty output transition. Similarly, if such an event were to occur during a transmitted pulse (and was of the worst-case polarity), it would reduce the received pulse from >1.0 V to 0.75 V—still well above the 0.5 V sensing threshold of the decoder.

The preceding magnetic flux density values correspond to specific current magnitudes at given distances away from the ADuM2400/ADuM2401/ADuM2402 transformers. Figure 20 expresses these allowable current magnitudes as a function of frequency for selected distances. As can be seen, the ADuM2400/ADuM2401/ADuM2402 is immune and can be affected only by extremely large currents operated at high frequency and very close to the component. For the 1 MHz example noted, place a 0.5 kA current 5 mm away from the ADuM2400/ADuM2401/ADuM2402 to affect the component's operation.

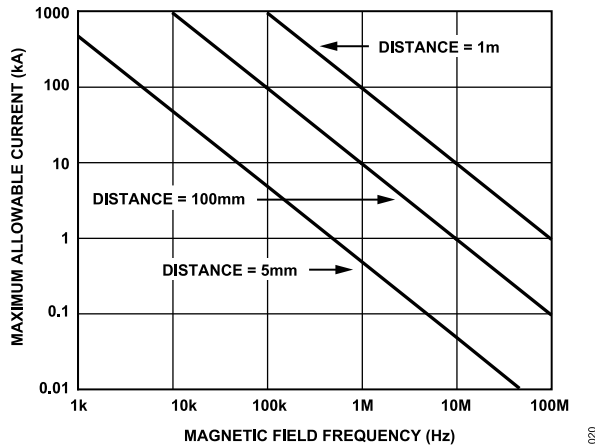

Figure 20. Maximum Allowable Current for Various Current-to-ADuM2400/ADuM2401/ADuM2402 Spacings

Note that at combinations of strong magnetic field and high frequency, any loops formed by printed circuit board traces could induce sufficiently large error voltages to trigger the thresholds of succeeding circuitry. Care should be taken in the layout of such traces to avoid this possibility.

POWER CONSUMPTION

The supply current at a given channel of the ADuM2400/ADuM2401/ADuM2402 isolator is a function of the supply voltage, the data rate of the channel, and the output load of the channel.

For each input channel, the supply current is given by:

$$I_{DDI} = I_{DDI(Q)} \quad f \leq 0.5f_r$$

$$I_{DDI} = I_{DDI(D)} \times (2f - f_r) + I_{DDI(Q)} \quad f > 0.5f_r$$

For each output channel, the supply current is given by:

$$I_{DDO} = I_{DDO(Q)} \quad f \leq 0.5f_r$$

$$I_{DDO} = (I_{DDO(D)} + (0.5 \times 10^{-3} \times C_L V_{DDO}) \times (2f - f_r) + I_{DDO(Q)}) \quad f > 0.5f_r$$

where:

- $I_{DDI(D)}$, $I_{DDO(D)}$ are the input and output dynamic supply currents per channel (mA/Mbps).
- C_L is the output load capacitance (pF).
- V_{DDO} is the output supply voltage (V).
- f is the input logic signal frequency (MHz, half of the input data rate, NRZ signaling).
- f_r is the input stage refresh rate (Mbps).
- $I_{DDI(Q)}$, $I_{DDO(Q)}$ are the specified input and output quiescent supply currents (mA).

To calculate the total I_{DD1} and I_{DD2} , the supply currents for each input and output channel corresponding to I_{DD1} and I_{DD2} are calculated and totaled. Figure 8 and Figure 9 provide per channel supply currents as a function of data rate for an unloaded output condition. Figure 10 provides per channel supply current as a function of data rate for a 15 pF output condition. Figure 11 through Figure 15 provide the total I_{DD1} and I_{DD2} as a function of data rate for the ADuM2400/ADuM2401/ADuM2402 channel configurations.

INSULATION LIFETIME

All insulation structures eventually break down when subjected to voltage stress over a sufficiently long period. The rate of insulation degradation is dependent on the characteristics of the voltage waveform applied across the insulation. In addition to the testing performed by the regulatory agencies, Analog Devices carries out an extensive set of evaluations to determine the lifetime of the insulation structure within the ADuM2400/ADuM2401/ADuM2402.

Analog Devices performs accelerated life testing using voltage levels higher than the rated continuous working voltage. Acceleration factors for several operating conditions are determined. These factors allow calculation of the time to failure at the actual working voltage. The values shown in Table 10 summarize the peak voltage for 50 years of service life for a bipolar ac operating condition and the maximum CSA/VDE approved working voltages. In many cases, the approved working voltage is higher than the 50-year service life voltage. Operation at these high working voltages can lead to shortened insulation life in some cases.

The insulation lifetime of the ADuM2400/ADuM2401/ADuM2402 depends on the voltage waveform type imposed across the isolation barrier. The iCoupler insulation structure degrades at different rates, depending on whether the waveform is bipolar ac, unipolar ac, or dc. Figure 21, Figure 22, and Figure 23 illustrate these different isolation voltage waveforms.

Bipolar ac voltage is the most stringent environment. The goal of a 50-year operating lifetime under the ac bipolar condition determines Analog Devices recommended maximum working voltage.

In the case of unipolar ac or dc voltage, the stress on the insulation is significantly lower. This allows operation at higher working

APPLICATION INFORMATION

voltages while still achieving a 50-year service life. The working voltages listed in [Table 10](#) can be applied while maintaining the 50-year minimum lifetime, provided the voltage conforms to either the unipolar ac or dc voltage cases. Any cross-insulation voltage waveform that does not conform to [Figure 22](#) or [Figure 23](#) should be treated as a bipolar ac waveform and its peak voltage should be limited to the 50-year lifetime voltage value listed in [Table 10](#).

Note that the voltage presented in [Figure 22](#) is shown as sinusoidal for illustration purposes only. It is meant to represent any voltage waveform varying between 0 V and some limiting value. The limiting value can be positive or negative, but the voltage cannot cross 0 V.

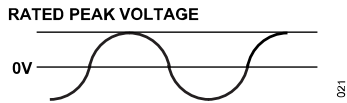

Figure 21. Bipolar AC Waveform

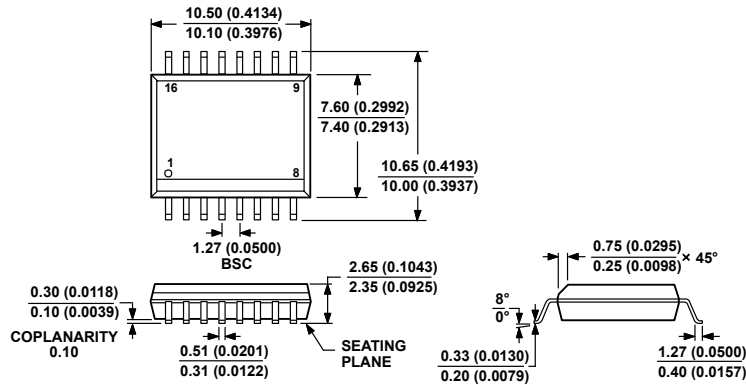

Figure 22. Unipolar AC Waveform



Figure 23. DC Waveform

OUTLINE DIMENSIONS



COMPLIANT TO JEDEC STANDARDS MS-013-AA
 CONTROLLING DIMENSIONS ARE IN MILLIMETERS; INCH DIMENSIONS
 (IN PARENTHESES) ARE ROUNDED-OFF MILLIMETER EQUIVALENTS FOR
 REFERENCE ONLY AND ARE NOT APPROPRIATE FOR USE IN DESIGN.

03-27-2007-B

Figure 24. 16-Lead Standard Small Outline Package [SOIC_W]
 Wide Body (RW-16)
 Dimensions shown in millimeters and (inches)

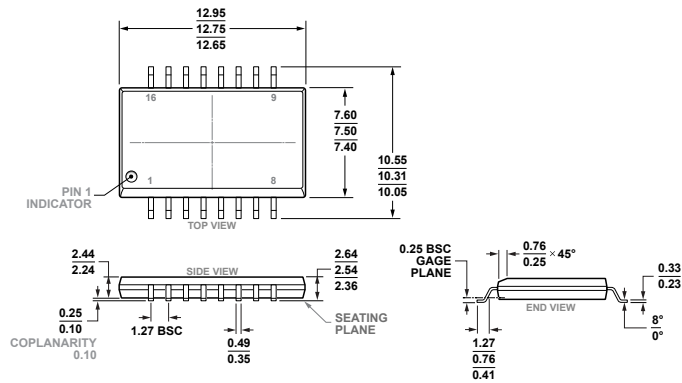

COMPLIANT TO JEDEC STANDARDS MS-013-AC

12-15-2017-B

Figure 25. 16-Lead Standard Small Outline Package, with Increased Creepage [SOIC_IC]
 Wide Body
 (RI-16-2)
 Dimensions shown in millimeters

Updated: April 11, 2023

ORDERING GUIDE

Model ¹	Temperature Range	Package Description	Packing Quantity	Package Option
ADUM2400ARIZ	-40°C to +105°C	16-Lead SOIC (Increased Creepage)		RI-16-2
ADUM2400ARIZ-RL	-40°C to +105°C	16-Lead SOIC (Increased Creepage)	Reel, 1000	RI-16-2
ADUM2400ARWZ	-40°C to +105°C	16-Lead SOIC Wide		RW-16
ADUM2400ARWZ-RL	-40°C to +105°C	16-Lead SOIC Wide	Reel, 1000	RW-16
ADUM2400BRIZ	-40°C to +105°C	16-Lead SOIC (Increased Creepage)		RI-16-2
ADUM2400BRIZ-RL	-40°C to +105°C	16-Lead SOIC (Increased Creepage)	Reel, 1000	RI-16-2
ADUM2400BRWZ	-40°C to +105°C	16-Lead SOIC Wide		RW-16
ADUM2400BRWZ-RL	-40°C to +105°C	16-Lead SOIC Wide	Reel, 1000	RW-16
ADUM2400CRIZ	-40°C to +105°C	16-Lead SOIC (Increased Creepage)		RI-16-2

OUTLINE DIMENSIONS

Model ¹	Temperature Range	Package Description	Packing Quantity	Package Option
ADUM2400CRIZ-RL	-40°C to +105°C	16-Lead SOIC (Increased Creepage)	Reel, 1000	RI-16-2
ADUM2400CRWZ	-40°C to +105°C	16-Lead SOIC Wide		RW-16
ADUM2400CRWZ-RL	-40°C to +105°C	16-Lead SOIC Wide	Reel, 1000	RW-16
ADUM2401ARIZ	-40°C to +105°C	16-Lead SOIC (Increased Creepage)		RI-16-2
ADUM2401ARIZ-RL	-40°C to +105°C	16-Lead SOIC (Increased Creepage)	Reel, 1000	RI-16-2
ADUM2401ARWZ	-40°C to +105°C	16-Lead SOIC Wide		RW-16
ADUM2401ARWZ-RL	-40°C to +105°C	16-Lead SOIC Wide	Reel, 1000	RW-16
ADUM2401BRIZ	-40°C to +105°C	16-Lead SOIC (Increased Creepage)		RI-16-2
ADUM2401BRIZ-RL	-40°C to +105°C	16-Lead SOIC (Increased Creepage)	Reel, 1000	RI-16-2
ADUM2401BRWZ	-40°C to +105°C	16-Lead SOIC Wide		RW-16
ADUM2401BRWZ-RL	-40°C to +105°C	16-Lead SOIC Wide	Reel, 1000	RW-16
ADUM2401CRIZ	-40°C to +105°C	16-Lead SOIC (Increased Creepage)		RI-16-2
ADUM2401CRIZ-RL	-40°C to +105°C	16-Lead SOIC (Increased Creepage)	Reel, 1000	RI-16-2
ADUM2401CRWZ	-40°C to +105°C	16-Lead SOIC Wide		RW-16
ADUM2401CRWZ-RL	-40°C to +105°C	16-Lead SOIC Wide	Reel, 1000	RW-16
ADUM2402ARIZ	-40°C to +105°C	16-Lead SOIC (Increased Creepage)		RI-16-2
ADUM2402ARIZ-RL	-40°C to +105°C	16-Lead SOIC (Increased Creepage)	Reel, 1000	RI-16-2
ADUM2402ARWZ	-40°C to +105°C	16-Lead SOIC Wide		RW-16
ADUM2402ARWZ-RL	-40°C to +105°C	16-Lead SOIC Wide	Reel, 1000	RW-16
ADUM2402BRIZ	-40°C to +105°C	16-Lead SOIC (Increased Creepage)		RI-16-2
ADUM2402BRIZ-RL	-40°C to +105°C	16-Lead SOIC (Increased Creepage)	Reel, 1000	RI-16-2
ADUM2402BRWZ	-40°C to +105°C	16-Lead SOIC Wide		RW-16
ADUM2402BRWZ-RL	-40°C to +105°C	16-Lead SOIC Wide	Reel, 1000	RW-16
ADUM2402CRIZ	-40°C to +105°C	16-Lead SOIC (Increased Creepage)		RI-16-2
ADUM2402CRIZ-RL	-40°C to +105°C	16-Lead SOIC (Increased Creepage)	Reel, 1000	RI-16-2
ADUM2402CRWZ	-40°C to +105°C	16-Lead SOIC Wide		RW-16
ADUM2402CRWZ-RL	-40°C to +105°C	16-Lead SOIC Wide	Reel, 1000	RW-16

¹ Z = RoHS Compliant Part.

EVALUATION BOARDS

Model ¹	Description
EVAL-ADUMQSEBZ	Evaluation Board

¹ Z = RoHS Compliant Part.

Looking for pricing, stock, or lifecycle information?

Click below to explore more details on WIN SOURCE:

 [View ADUM2400ARIZ on WIN SOURCE](#)

 [Analog Devices Inc. Information](#)

Optimize Your Supply Chain with WIN SOURCE Solutions

-  Global Sourcing Solution
-  Obsolete Management
-  Cost Control Management
-  Shortage Management
-  Alternative Solution
-  Excess Inventory Management