



**THE DATASHEET OF
ADS54RF63EVM**



ADS5440/44/63/74 EVM

User's Guide

Contents

1	Overview	5
1.1	Purpose.....	5
1.2	EVM Basic Functions.....	5
1.3	Power Requirements	5
1.4	ADS5463 EVM Operational Procedure	5
2	Circuit Description	7
2.1	Schematic Diagram	7
2.2	Circuit Function.....	7
2.3	Test Points.....	10
2.4	ADC Options	10
3	Physical Description	11
3.1	PCB Layout.....	11
3.2	Bill of Materials.....	18
3.3	PCB Schematics.....	19
	Important Notices	23

List of Figures

1	Smith Chart	8
2	THS9001 + ADS5463 FFT Plot	9
3	Top Silkscreen	11
4	Component Side	12
5	Ground Plane 1	13
6	Power Plane 1	14
7	Power Plane 2	15
8	Ground Plane 2	16
9	Bottom Side	17
10	EVM Schematics	19
11	EVM Schematics	20
12	EVM Schematics	21
13	EVM Schematics	21
14	Touchless Probe Breakout Board Schematic	22

List of Tables

1	Three-Pin Jumper List	6
2	EVM Power Supply Options	7
3	Output Connector J5	10
4	Bill of Materials	18

ADS5440/44/63/74 EVM

1 Overview

This user's guide gives a general overview of the ADS5440/44/63/74 evaluation module (EVM) and provides a general description of the features and functions to be considered while using this module.

1.1 Purpose

The EVM provides a platform for evaluating the analog-to-digital converter (ADC) under various signal, reference, and supply conditions. This document should be used in combination with the EVM schematic diagram supplied.

1.2 EVM Basic Functions

Two analog inputs to the ADC are provided via external SMA connectors. One input path uses a pair of THS9001 amplifiers, while the other input is ac-coupled. In both cases, the user supplies a single-ended input, which is converted into a differential signal.

The EVM provides an external SMA connector for input of the ADC clock. The single-ended input is converted into a differential signal at the input of the device.

Digital output from the EVM is via a high-speed, high-density Samtec output header. A breakout board is provided for high-speed logic analyzer touchless probing solutions from both Agilent and Tektronix. Both the Agilent E5405A and Tektronix P6980 probes are supported.

Power connections to the EVM are via banana jack sockets. Separate sockets are provided for the ADC analog and digital supplies and for the differential amplifier supply.

1.3 Power Requirements

The EVM can be powered directly with only three supplies: a 3.3-V supply for both ADC analog and digital driver supply, and 5 V for the ADC analog supply.

CAUTION

Voltage Limits: Exceeding the maximum input voltages can damage EVM components. Undervoltage may cause improper operation of some or all of the EVM components.

1.4 ADS5463 EVM Operational Procedure

The ADS5463 EVM provides a flexible means of evaluating the ADS5463 in a number of modes of operation. A basic setup procedure that can be used as a board confidence check is as follows:

1. Verify all jumper settings against the schematic jumper list in [Table 1](#).

Table 1. Three-Pin Jumper List

JUMPER	FUNCTION	LOCATION: PINS 1–2	LOCATION: PINS 2–3	DEFAULT
JP3	Provides AIN+ source to ADS5463	Source provided from differential amplifier	Source provided from T2	2–3
JP4	Provides AIN– source to ADS5463	Source provided from differential amplifier	Source provided from T2	2–3
J20	ADC	ADS5440/44	ADS5463/74	2–3
J21	ADS5474 Power Down	ADS5474 Normal Operation	ADS5474 Power Down	1-2

2. Connect supplies to the EVM as follows:
 - 5 V (4.75 V–5.25 V) ADC analog supply to J12 and return to J9
 - 3.3 V (3 V–3.6 V) ADC analog supply to J14 and return to J9
 - 3.3 V (3 V–3.6V) ADC digital buffer supply to J7 and return to J8
3. Switch power supplies on.
4. Using a function generator with 50-Ω output, generate a 0-V offset, 1.5-V_{pp} sine-wave clock into J17. The frequency of the clock must be within the specification for the device speed grade.
5. Use a frequency generator with a 50-Ω output to provide a 15.5-MHz, 0-V offset, –1-dBFS-amplitude sine-wave signal into J11. This provides a transformer-coupled differential input signal to the ADC.
6. The digital pattern on output connector J5 should now represent a sine wave and can be monitored using the supplied logic analyzer breakout board.

2 Circuit Description

2.1 Schematic Diagram

The schematic diagram for the EVM is attached to the end of this document.

2.2 Circuit Function

The following sections describe the function of individual circuits. Refer to the relevant data sheet for device operating characteristics.

2.2.1 Power

Power is supplied to the EVM via banana jack sockets. The EVM offers the capability to supply 5 V, 3.3 V analog, and digital 3.3 V independently. The heat slug is tied to AGND with multiple vias to provide for thermal dissipation. [Table 2](#) offers a snapshot of the power-supply options. All supplies are required for default operation, except J18 and J19.

Table 2. EVM Power Supply Options

EVM Banana Jack	DESCRIPTION
J7	ADS5463 3.3-V digital supply
J8	AGND
J9	AGND
J12	ADS5463 5-V analog supply
J14	ADS5463 3.3-V analog supply
J18	THS9001 5-V supply
J19	AGND

2.2.2 Clock Input

A single-ended square or sinusoidal clock input should be applied to J17. The clock frequency should not exceed 500 MHz. The clock input is converted to differential signal by a Coilcraft WBC4-1W, which has an impedance ratio of 4. It is important to note that voltage applied to J17 is stepped up by a factor of two.

2.2.3 Analog Inputs

The EVM can be configured to use either a balun-coupled input or a TI 9001 amplifier input, both from a single-ended source. The inputs are provided via SMA connectors J11 for a balun coupled input and J10 for the amplifier input. To set up for one of these options, the EVM must be configured as follows:

1. For a 1:1 transformer-coupled input to the ADC, a single-ended source is connected to J11. JP3 has pins 1 and 2 shorted, and JP4 has pins 2 and 3 shorted. This is the default configuration for the EVM. The MACOM ETC1-1-13 forms an inherent band-pass filter with a pass band from 4 MHz to 1 GHz, with no more than 1dB insertion loss. A dual balun configuration has been provided which can improve harmonic distortion performance at higher input frequencies (100 MHz+). It should be noted that excellent results have also been obtained using a single Mini-Circuits JTX4-10T transformer. Transformers can be used in place of the baluns, in which case C58 and C77 can be replaced with 0- Ω resistors, as the ADC features a self-biased input. When choosing a balun or transformer, it is important to take careful consideration of its amplitude and phase performance. Circuit placeholders L7, C88, and C68 are provided if impedance matching is needed at a specific frequency. By default, these are not populated. The termination resistors have been tuned to represent a broadband 50- Ω impedance over the first two Nyquist zones. [Figure 1](#) shows the Smith chart of the input impedance over four Nyquist zones.

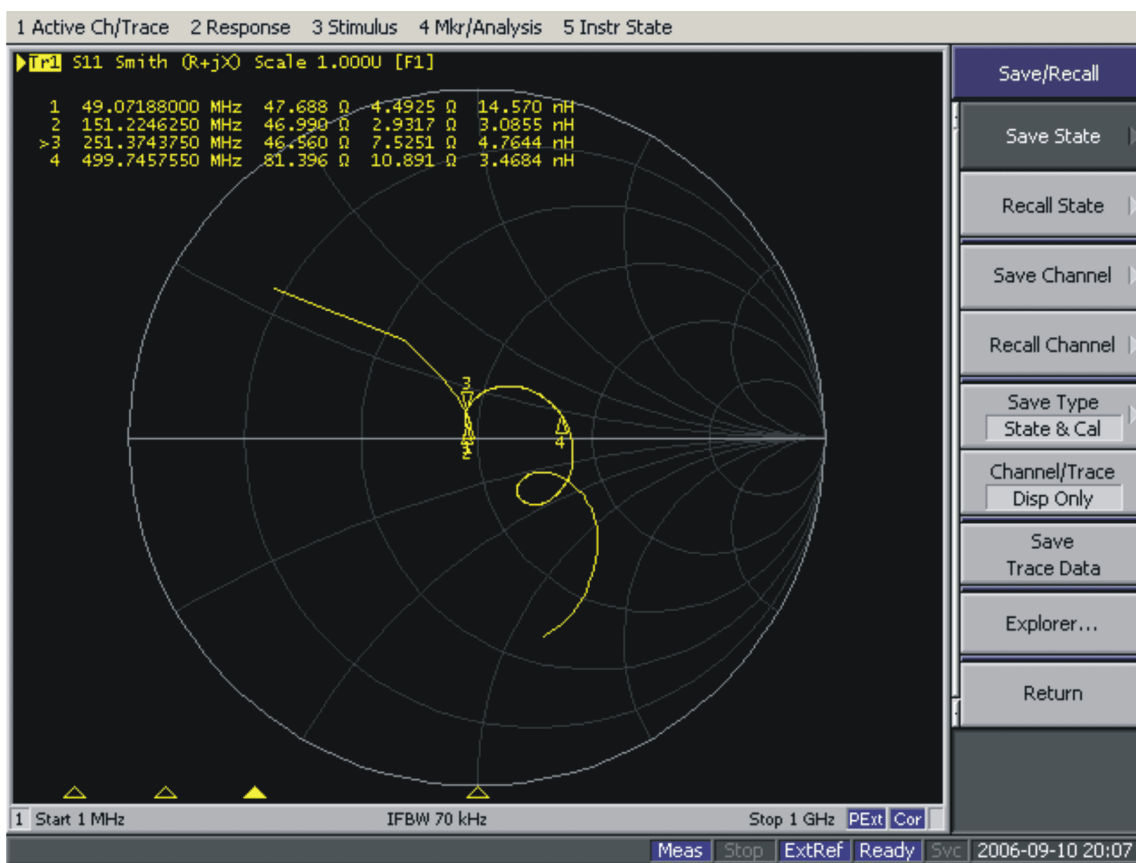

C001

Figure 1. Smith Chart

- One can use two TI THS9001 IF amplifiers to drive the ADC by applying an input to J10. Reconfigure JP3 and JP4, such that both have pins 1 and 2 shorted. To provide power to the amplifiers, connect 5 Vdc to J18 and connect the ground return to J19. The EVM is configured by default with a 170-MHz band-pass filter. Users can adjust this by tuning L12 and C75. Figure 2 shows the performance of the EVM when using the THS9001 amplifier path.

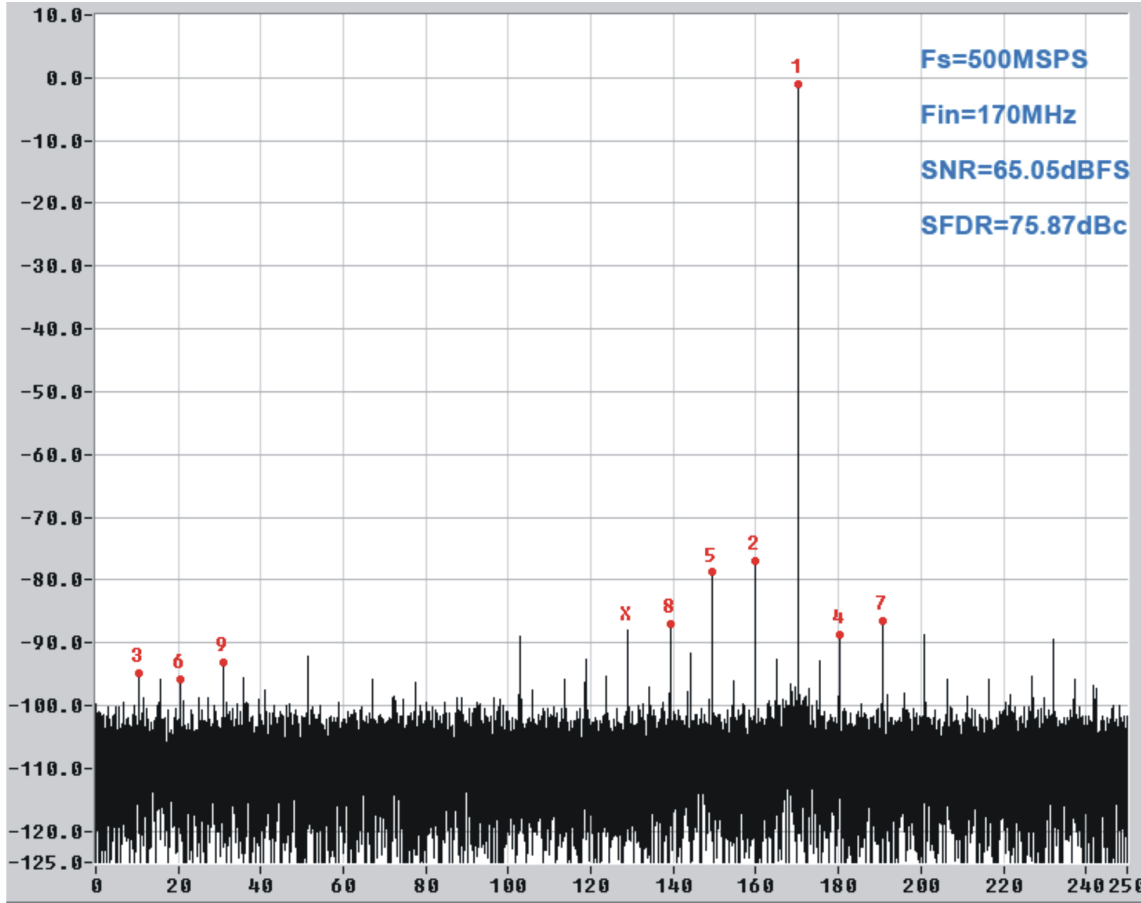

C002

Figure 2. THS9001 + ADS5463 FFT Plot

2.2.4 Digital Outputs

The LVDS digital outputs can be accessed through the J5 output connector. A parallel 100- Ω termination resistor must be placed at the receiver to properly terminate each LVDS data pair. The supplied logic analyzer breakout board includes the 100- Ω terminations at the logic analyzer probe point. If using the logic analyzer breakout board, [Table 3](#) use for configuration details. When using a logic analyzer, the ADC DRY clock used to latch in the data must be configured in the DDR mode.

Table 3. Output Connector J5

EVM Net Description	Breakout Board Schematic Net Name	Logic Analyzer Default Assignments using Breakout Board
No Connect	D0	D[0] - Ignore
OVR	D1	D[1] - Ignore
MSB	D2	D[2] - MSB
MSB-1	D3	D[3]
MSB-2	D4	D[4]
MSB-3	D5	D[5]
MSB-4	D6	D[6]
MSB-5	D7	D[7]
MSB-6	D8	D[8]
MSB-7	D9	D[9]
MSB-8	D10	D[10]
MSB-9	D11	D[11]
MSB-10	D12	D[12]
MSB-11 (LSB - ADS5463)	D13	D[13]
MSB-12 (LSB - ADS5440\44)	D14	D[14]
MSB-13 (LSB - ADS5474)	D15	D[15]

2.3 Test Points

The EVM provides several different access points to monitor ADC voltages.

- TP1 provides access to the ADC VREF voltage.
- TP2 (ADS5474 only) provides access to the ADS5474 VCM.

2.4 ADC Options

The EVM layout has been designed to showcase the family migration ability. Customers can easily design one layout to accommodate both the ADS5463/74 and the ADS5440/44 family of ADCs.

- To use the ADS5440/44 device on this EVM, one must set jumper J20 to short pins 1–2, which connects 5 V to the digital output buffer of the device. To use the ADS5463/74 connect jumper J20 to short pins 2–3.
- The ADS5474 has several modes the ADS5440/44/63 ADCs do not have. Pin 29 becomes a VCM and pin 33 becomes a power down when asserted high. In the case of the ADS5440/44/63 these pins can be left unconnected or grounded.

3 Physical Description

This chapter describes the physical characteristics and PCB layout of the EVM.

3.1 PCB Layout

The EVM is constructed on a 6-layer, 0.062-inch thick PCB using FR-4 material. The individual layers are shown in Figure 3 through Figure 9. The layout features a common ground plane; however, similar performance can be had with careful layout using a split ground plane.

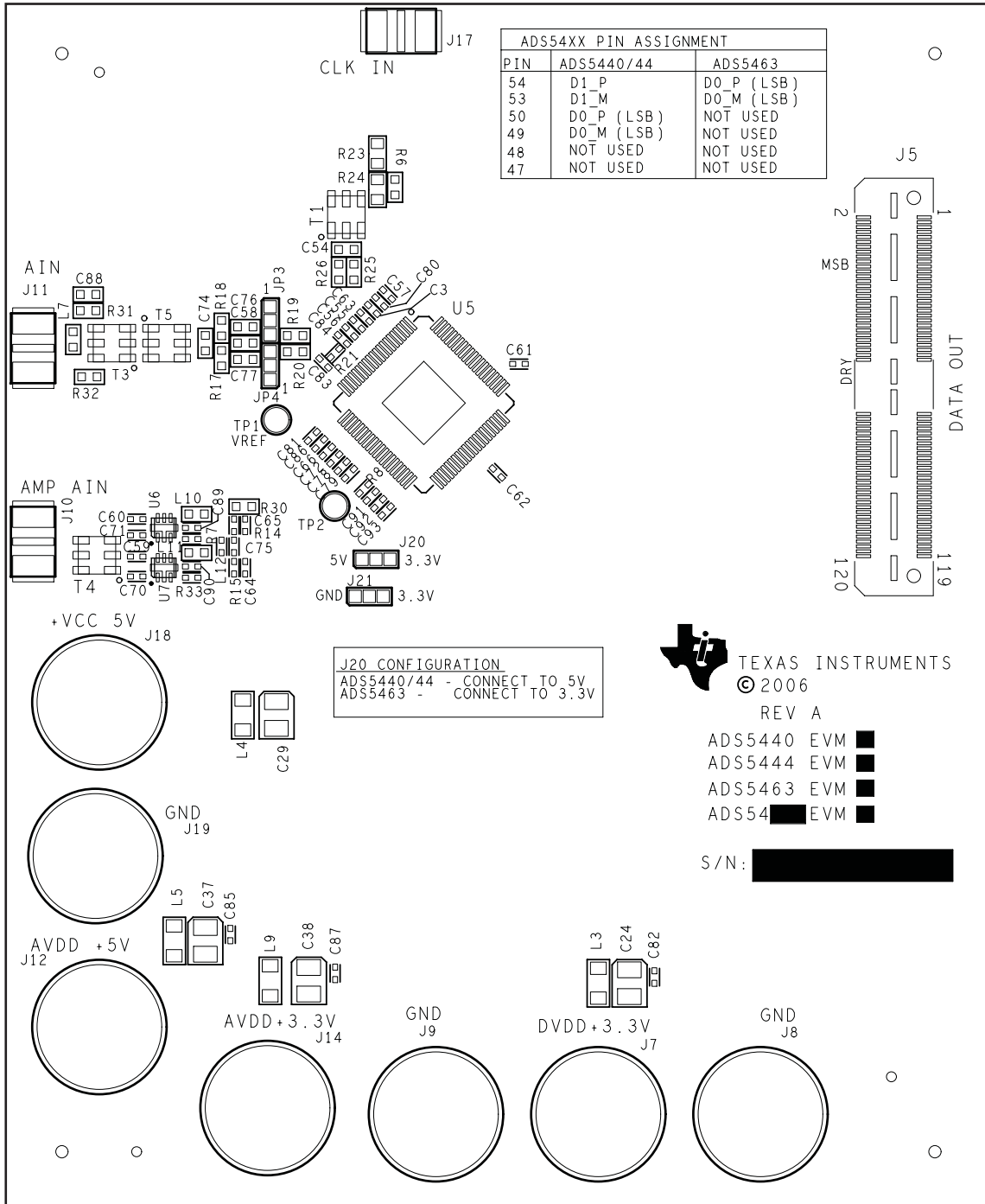

K001

Figure 3. Top Silkscreen

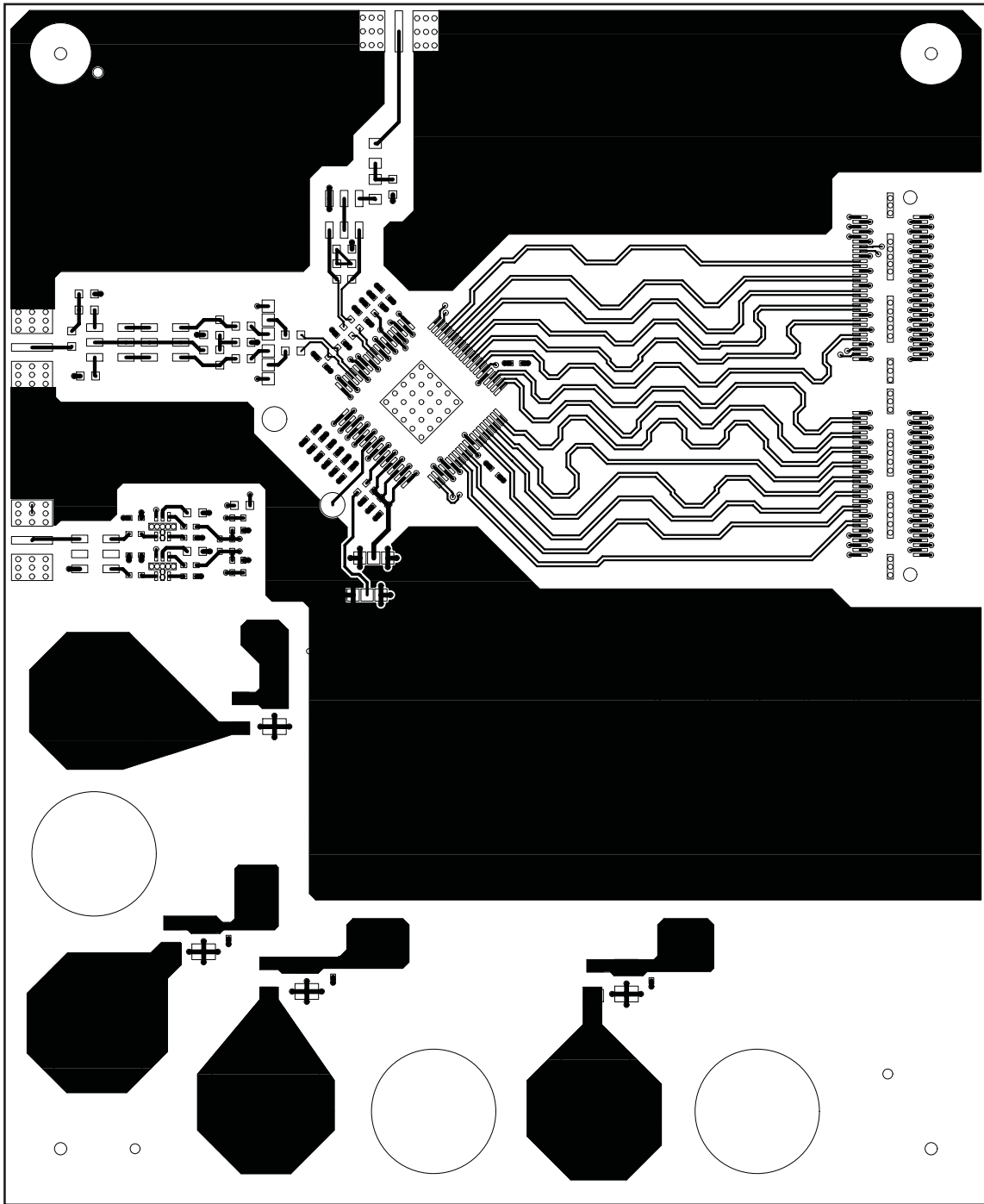

K002

Figure 4. Component Side

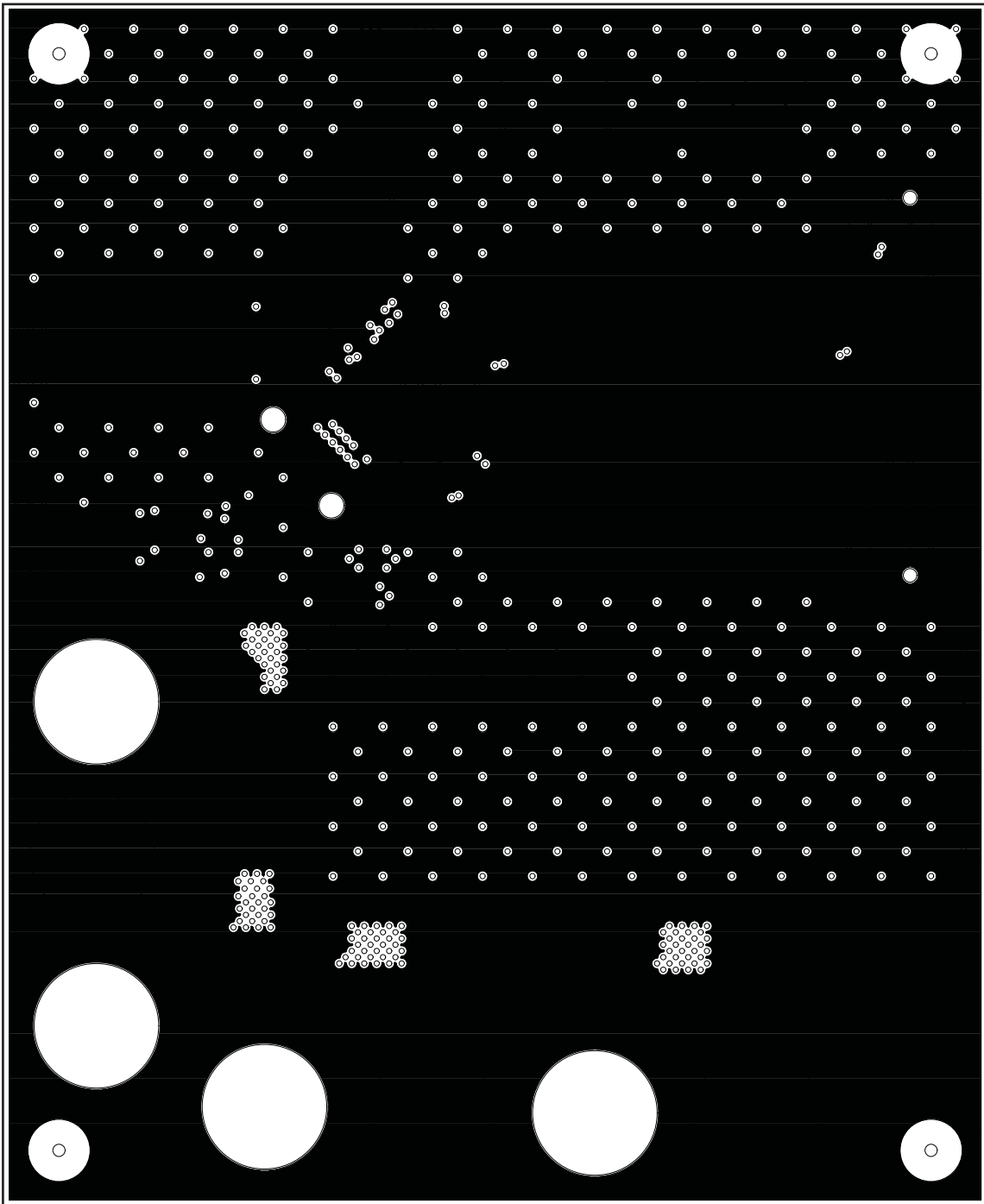

K003

Figure 5. Ground Plane 1

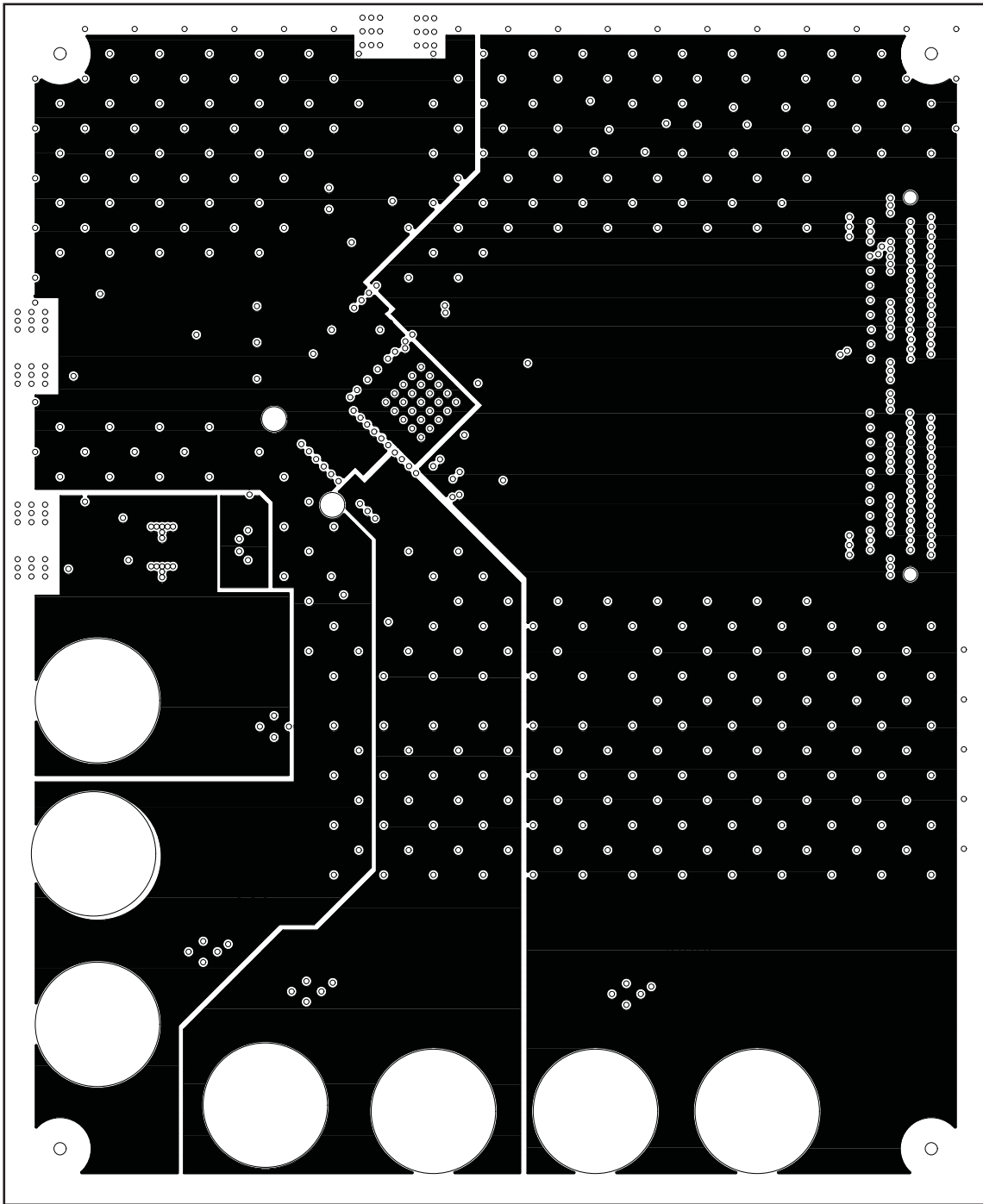

K004

Figure 6. Power Plane 1

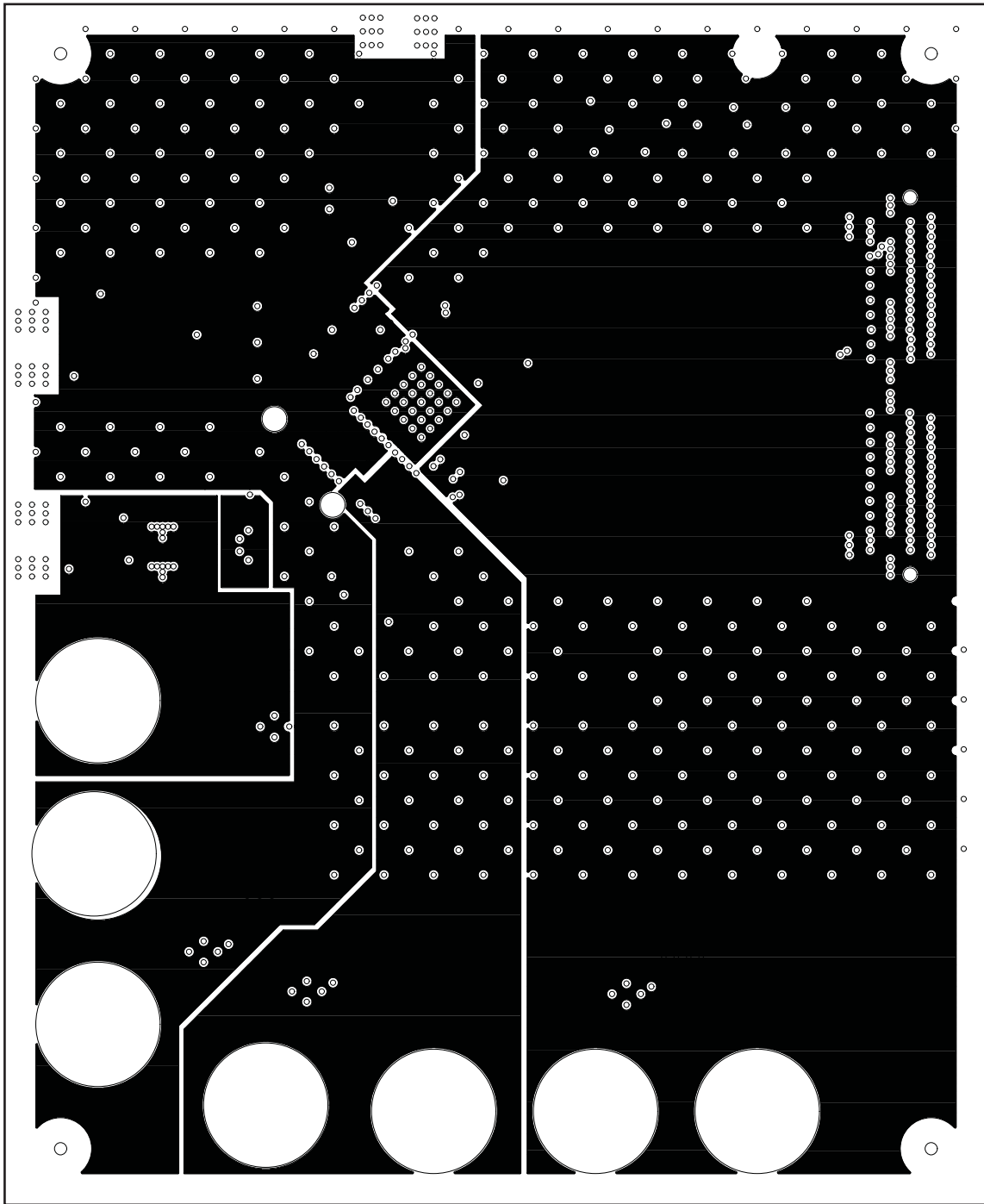

K005

Figure 7. Power Plane 2

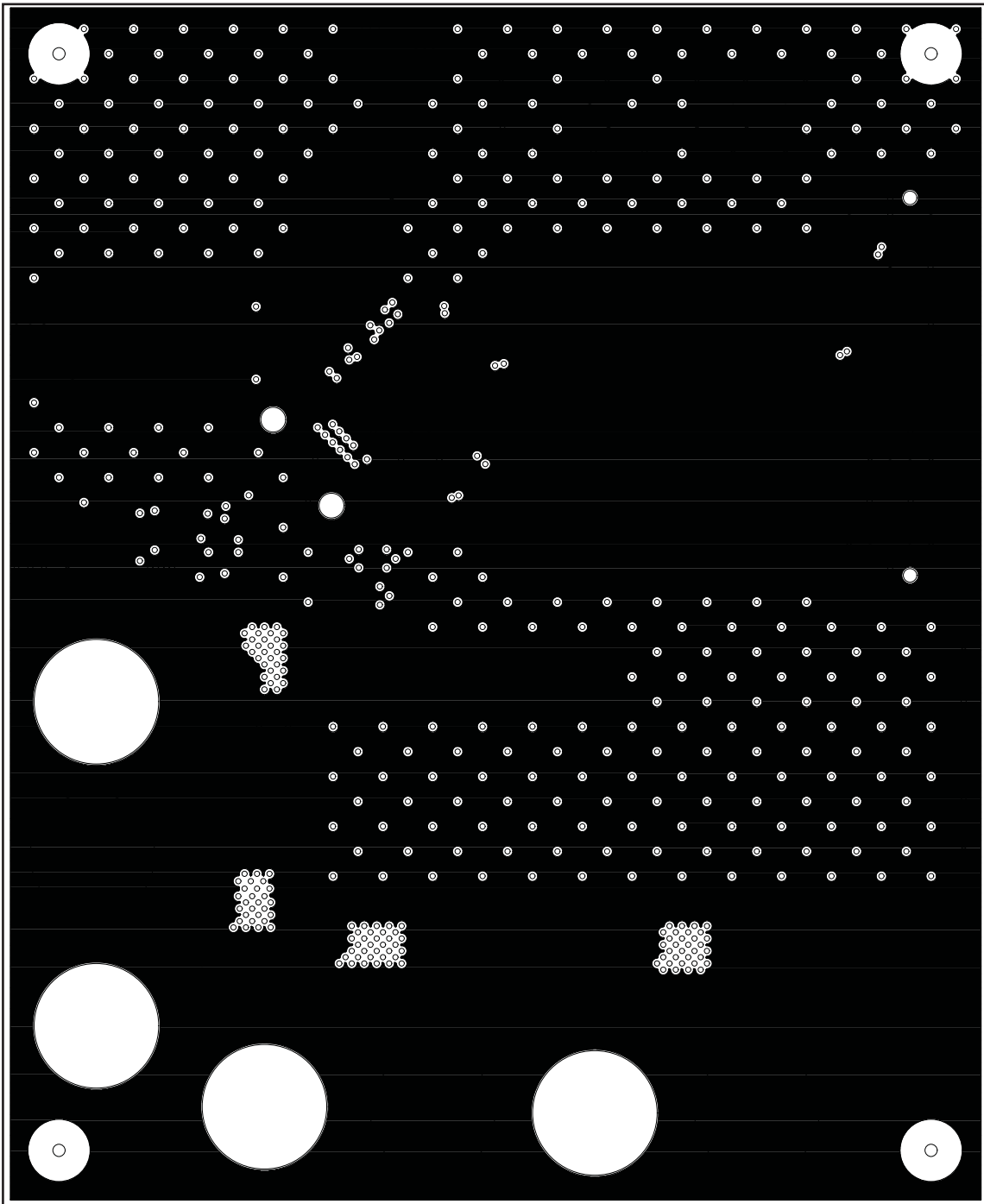

K006

Figure 8. Ground Plane 2

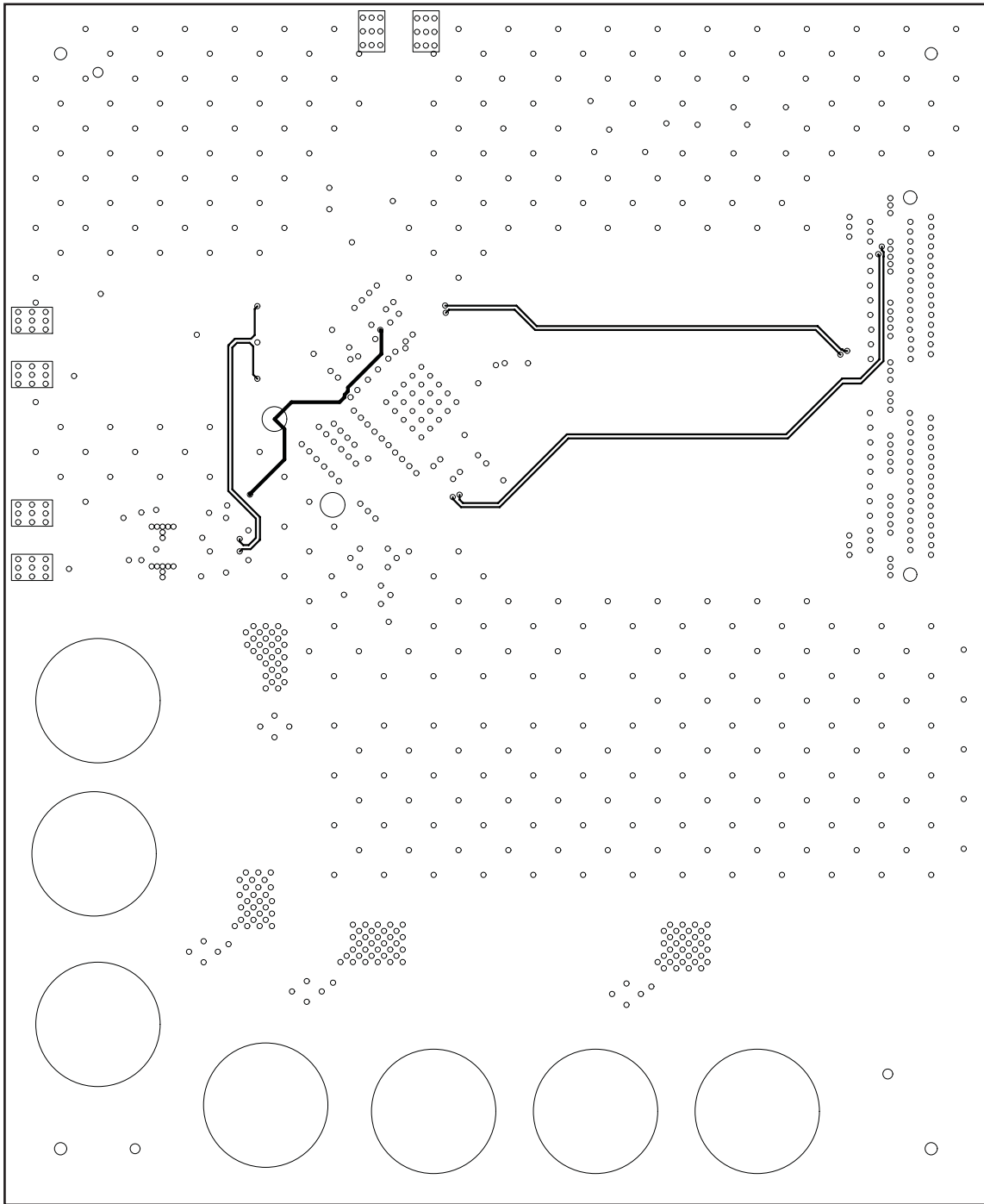

K007

Figure 9. Bottom Side

3.2 Bill of Materials

Table 4. Bill of Materials

QTY	PART REFERENCE	VALUE	PCB FOOTPRINT	MFR NAME	MFR PART NUMBER	NOTE
23	C3, C55, C56, C57, C59, C60, C61, C62, C63, C64, C65, C66, C72, C78, C79, C80, C81, C83, C84, C86, C91, C92, C93	0.1 μ F	0402	Panasonic	ECJ-0EB1A104K	
4	C24, C29, C37, C38	33 μ F	TANT_B	EPCOS, Inc.	B45196H2336M209	
1	C54	0.1 μ F	0603	Panasonic	ECJ-0EB1A104K	
2	C58, C74	0.1 μ F	0603	Panasonic	ECJ-1VB1C104K	
4	C70, C71, C89, C90	1000 pF	0402	Panasonic	ECJ-0EB1H102K	
1	C75	39 pF	0603	Panasonic	ECJ-0EC1H390J	
2	C76, C77	1 μ F	0603	Panasonic	ECJ-1VB1A105K	
2	C82, C85, C87	1 μ F	0402	Panasonic	ECJ-0EB1A105M	
0	C88	6.8 pF	0603	Panasonic	ECD-G0E6R8C	Do not install
2	JP3, JP4	Jumper_1x3_SMT			NO PART	
1	J5	CONN_QTH_30X2-D-A			QTH-60-02-F-D-A	
4	J7, J12, J14, J18	RED		Allied Electronics	ST-351A	
3	J8, J9, J19	BLK		Allied Electronics	ST-351B	
3	J10, J11, J17	SMA_END_RND		Johnson Components	142-0711-821	
1	J20	HEADER 3			NO PART	
1	J21	HEADER 3			NO PART	
4	L3, L4, L5, L9	68 Ω @ 100 MHz	1206	Panasonic	EXC-ML32A680U	
1	L7	0 Ω	0603	Panasonic	ERJ-8GEY0R00V	
2	L10, L11	470 nH	0603	Murata	LQW18ANR47J00D	
1	L12	18 nH	0402	Murata	LQW15AN18NJ00D	
1	R6	49.9 Ω	0603	Panasonic	ERJ-3EKF49R9V	
2	R7, R33	237 Ω	0402	Panasonic	ERJ-2RKF2370X	
1	R8	10 k Ω	0402	Panasonic	ERJ-2RKF1002X	
2	R14, R15	49.9 Ω	0402	Panasonic	ERJ-2RKF49R9X	
2	R17, R18	39 Ω	0603	Panasonic	RC0603FR-0739RL	
2	R19, R20	10 Ω	0603	Panasonic	ERJ-3EKF10R0V	
0	R21	200 Ω	0402	Panasonic	ERJ-2RKF2000X	Do not install
2	R23, R24	0 Ω	0805	Panasonic	ERJ-6GEY0R00V	
0	R25, R26	121 Ω	0603	Panasonic	ERJ-3EKF1210V	Do not install
0	R30, R3,1 R32	0 Ω	0603	Panasonic	ERJ-3GEY0R00V	Do not install
1	T1	WBC4-1W		Coilcraft	WBC4-1W	
1	T4	WBC2-1W		Coilcraft	WBC2-1W	
2	T3, T5	ETC1-1-13		Macom	ETC1-1-13	
1	TP1	BLK		Keystone	5001K	
1	U6, U7	THS9001		TI	THS9001	
1	U5	ADS5463		TI	ADS5463	See ⁽¹⁾

⁽¹⁾ Populate with ADS5440, ADS5444, ADS5463 depending on build.

3.3 PCB Schematics

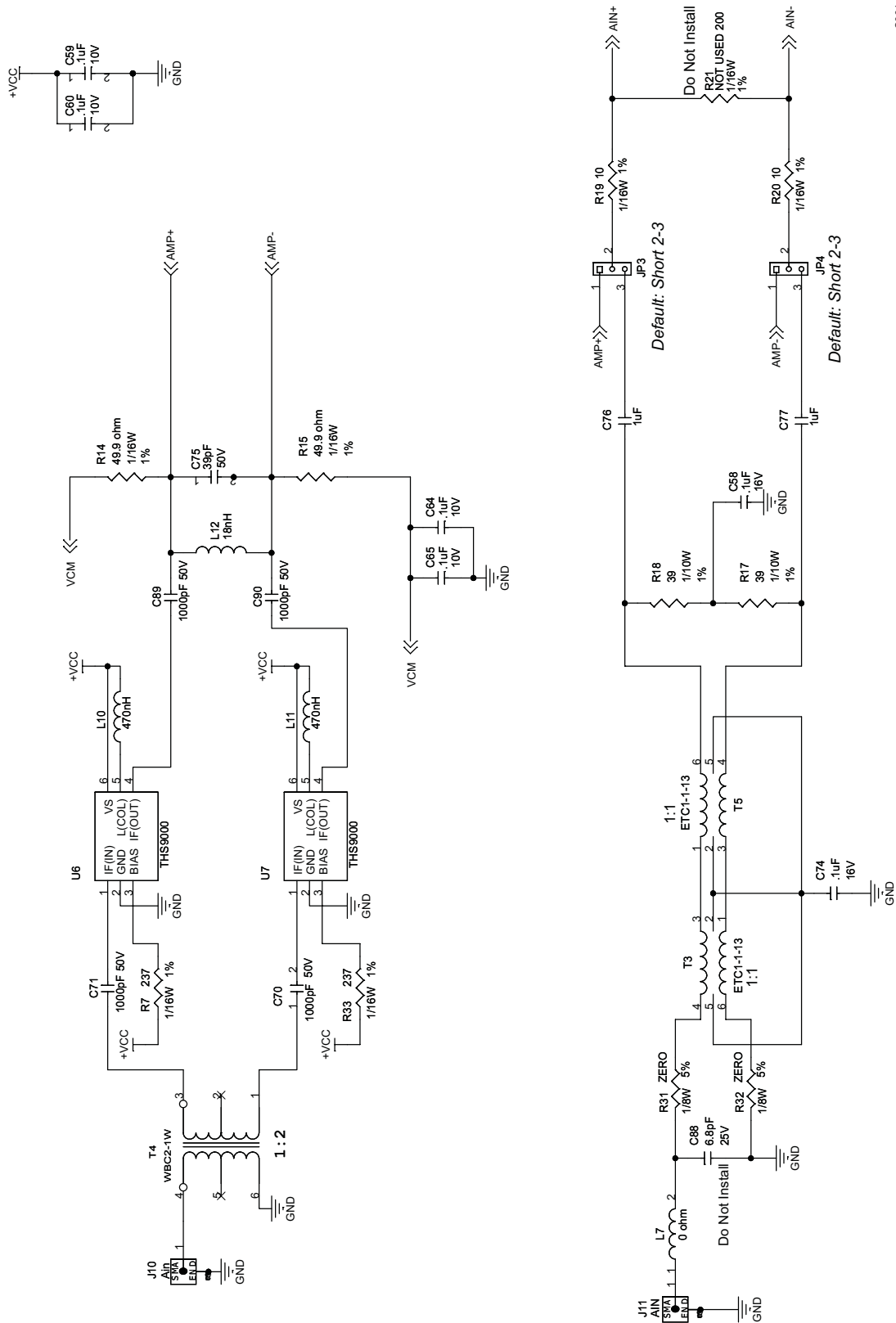

S001

Figure 10. EVM Schematics

Physical Description

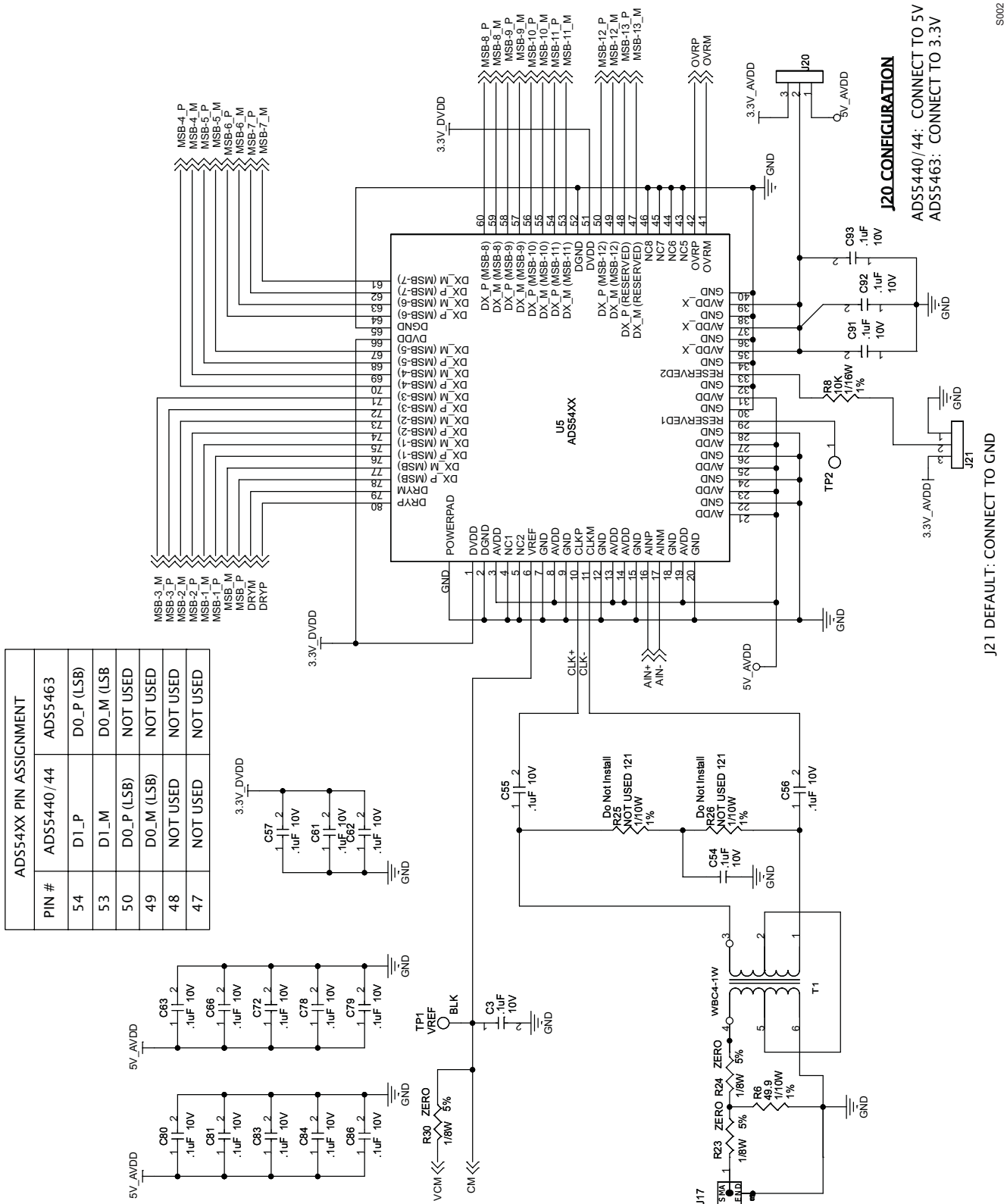

Figure 11. EVM Schematics

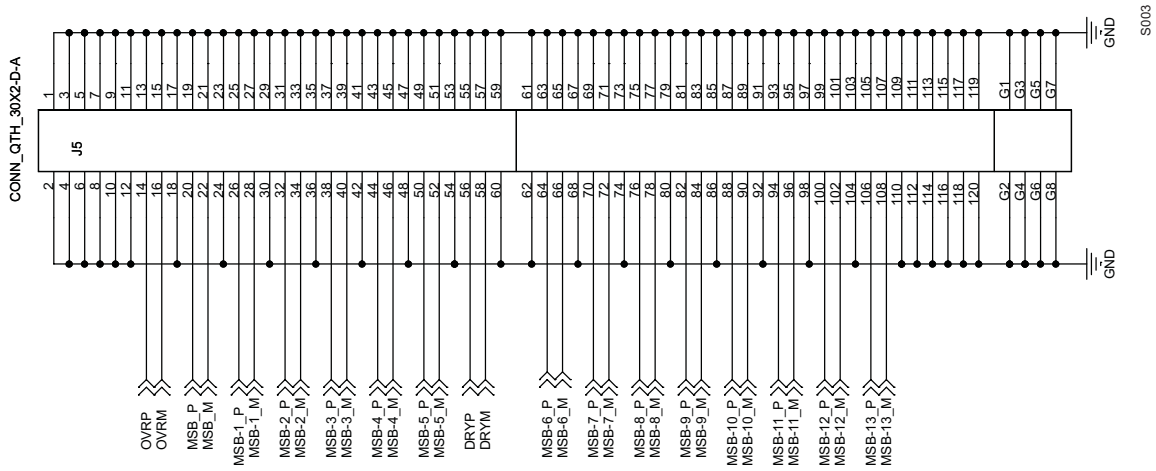

Figure 12. EVM Schematics

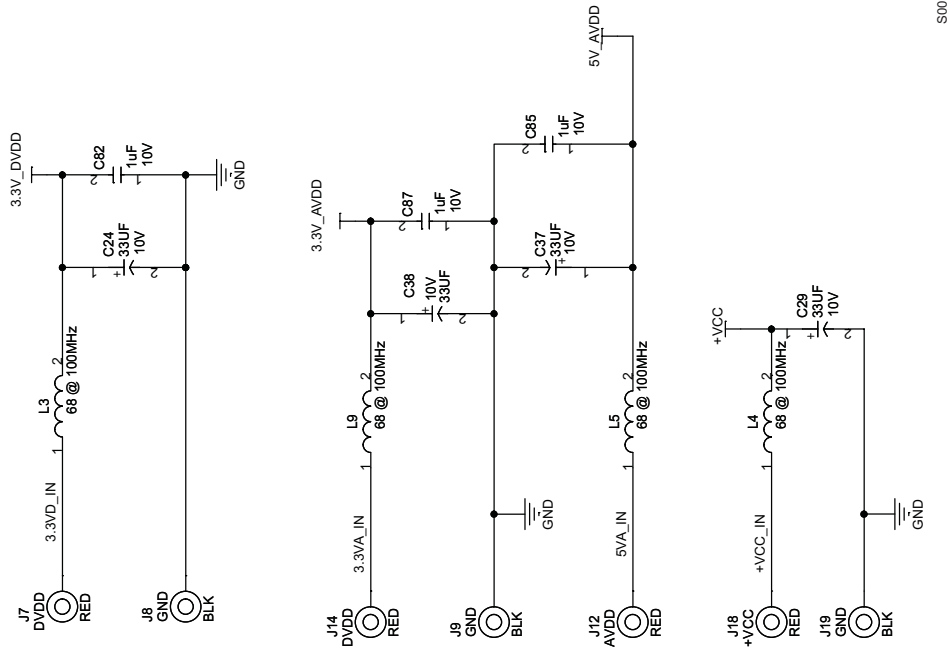

Figure 13. EVM Schematics

Physical Description

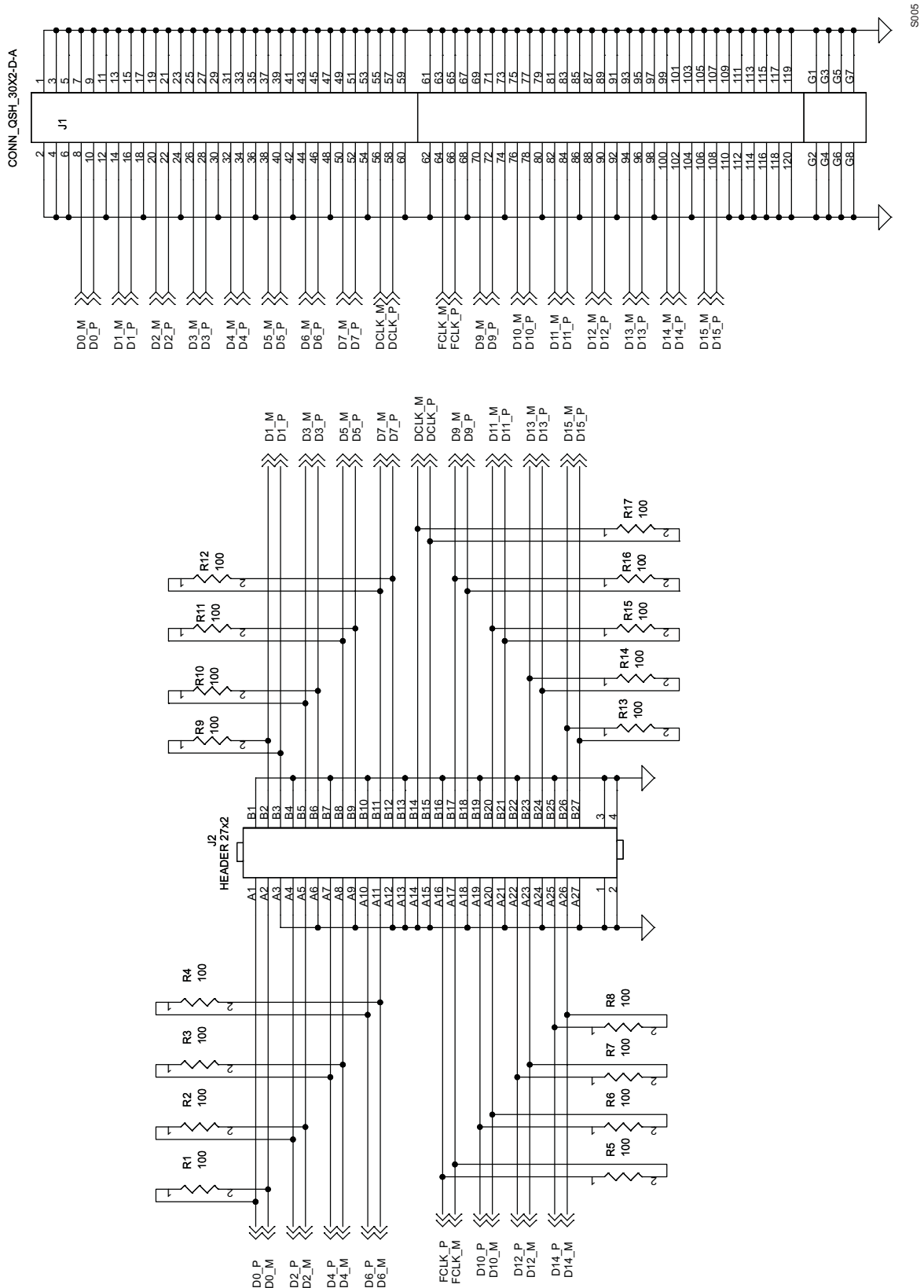

Figure 14. Touchless Probe Breakout Board Schematic

EVALUATION BOARD/KIT IMPORTANT NOTICE

Texas Instruments (TI) provides the enclosed product(s) under the following conditions:

This evaluation board/kit is intended for use for **ENGINEERING DEVELOPMENT, DEMONSTRATION, OR EVALUATION PURPOSES ONLY** and is not considered by TI to be a finished end-product fit for general consumer use. Persons handling the product(s) must have electronics training and observe good engineering practice standards. As such, the goods being provided are not intended to be complete in terms of required design-, marketing-, and/or manufacturing-related protective considerations, including product safety and environmental measures typically found in end products that incorporate such semiconductor components or circuit boards. This evaluation board/kit does not fall within the scope of the European Union directives regarding electromagnetic compatibility, restricted substances (RoHS), recycling (WEEE), FCC, CE or UL, and therefore may not meet the technical requirements of these directives or other related directives.

Should this evaluation board/kit not meet the specifications indicated in the User's Guide, the board/kit may be returned within 30 days from the date of delivery for a full refund. **THE FOREGOING WARRANTY IS THE EXCLUSIVE WARRANTY MADE BY SELLER TO BUYER AND IS IN LIEU OF ALL OTHER WARRANTIES, EXPRESSED, IMPLIED, OR STATUTORY, INCLUDING ANY WARRANTY OF MERCHANTABILITY OR FITNESS FOR ANY PARTICULAR PURPOSE.**

The user assumes all responsibility and liability for proper and safe handling of the goods. Further, the user indemnifies TI from all claims arising from the handling or use of the goods. Due to the open construction of the product, it is the user's responsibility to take any and all appropriate precautions with regard to electrostatic discharge.

EXCEPT TO THE EXTENT OF THE INDEMNITY SET FORTH ABOVE, NEITHER PARTY SHALL BE LIABLE TO THE OTHER FOR ANY INDIRECT, SPECIAL, INCIDENTAL, OR CONSEQUENTIAL DAMAGES.

TI currently deals with a variety of customers for products, and therefore our arrangement with the user **is not exclusive**.

TI assumes **no liability for applications assistance, customer product design, software performance, or infringement of patents or services described herein.**

Please read the User's Guide and, specifically, the Warnings and Restrictions notice in the User's Guide prior to handling the product. This notice contains important safety information about temperatures and voltages. For additional information on TI's environmental and/or safety programs, please contact the TI application engineer or visit www.ti.com/esh.

No license is granted under any patent right or other intellectual property right of TI covering or relating to any machine, process, or combination in which such TI products or services might be or are used.

FCC Warning

This evaluation board/kit is intended for use for **ENGINEERING DEVELOPMENT, DEMONSTRATION, OR EVALUATION PURPOSES ONLY** and is not considered by TI to be a finished end-product fit for general consumer use. It generates, uses, and can radiate radio frequency energy and has not been tested for compliance with the limits of computing devices pursuant to part 15 of FCC rules, which are designed to provide reasonable protection against radio frequency interference. Operation of this equipment in other environments may cause interference with radio communications, in which case the user at his own expense will be required to take whatever measures may be required to correct this interference.

EVM WARNINGS AND RESTRICTIONS

It is important to operate this EVM within the input voltage range of $-0.3V$ to $+3.6V$ and the output voltage range of $-0.3V$ to $+3.6V$.

Exceeding the specified input range may cause unexpected operation and/or irreversible damage to the EVM. If there are questions concerning the input range, please contact a TI field representative prior to connecting the input power.

Applying loads outside of the specified output range may result in unintended operation and/or possible permanent damage to the EVM. Please consult the EVM User's Guide prior to connecting any load to the EVM output. If there is uncertainty as to the load specification, please contact a TI field representative.

During normal operation, some circuit components may have case temperatures greater than $+25^{\circ}C$. The EVM is designed to operate properly with certain components above $+50^{\circ}C$ as long as the input and output ranges are maintained. These components include but are not limited to linear regulators, switching transistors, pass transistors, and current sense resistors. These types of devices can be identified using the EVM schematic located in the EVM User's Guide. When placing measurement probes near these devices during operation, please be aware that these devices may be very warm to the touch.

Mailing Address: Texas Instruments, Post Office Box 655303, Dallas, Texas 75265
Copyright © 2007, Texas Instruments Incorporated

IMPORTANT NOTICE

Texas Instruments Incorporated and its subsidiaries (TI) reserve the right to make corrections, modifications, enhancements, improvements, and other changes to its products and services at any time and to discontinue any product or service without notice. Customers should obtain the latest relevant information before placing orders and should verify that such information is current and complete. All products are sold subject to TI's terms and conditions of sale supplied at the time of order acknowledgment.

TI warrants performance of its hardware products to the specifications applicable at the time of sale in accordance with TI's standard warranty. Testing and other quality control techniques are used to the extent TI deems necessary to support this warranty. Except where mandated by government requirements, testing of all parameters of each product is not necessarily performed.

TI assumes no liability for applications assistance or customer product design. Customers are responsible for their products and applications using TI components. To minimize the risks associated with customer products and applications, customers should provide adequate design and operating safeguards.

TI does not warrant or represent that any license, either express or implied, is granted under any TI patent right, copyright, mask work right, or other TI intellectual property right relating to any combination, machine, or process in which TI products or services are used. Information published by TI regarding third-party products or services does not constitute a license from TI to use such products or services or a warranty or endorsement thereof. Use of such information may require a license from a third party under the patents or other intellectual property of the third party, or a license from TI under the patents or other intellectual property of TI.

Reproduction of TI information in TI data books or data sheets is permissible only if reproduction is without alteration and is accompanied by all associated warranties, conditions, limitations, and notices. Reproduction of this information with alteration is an unfair and deceptive business practice. TI is not responsible or liable for such altered documentation. Information of third parties may be subject to additional restrictions.

Resale of TI products or services with statements different from or beyond the parameters stated by TI for that product or service voids all express and any implied warranties for the associated TI product or service and is an unfair and deceptive business practice. TI is not responsible or liable for any such statements.

TI products are not authorized for use in safety-critical applications (such as life support) where a failure of the TI product would reasonably be expected to cause severe personal injury or death, unless officers of the parties have executed an agreement specifically governing such use. Buyers represent that they have all necessary expertise in the safety and regulatory ramifications of their applications, and acknowledge and agree that they are solely responsible for all legal, regulatory and safety-related requirements concerning their products and any use of TI products in such safety-critical applications, notwithstanding any applications-related information or support that may be provided by TI. Further, Buyers must fully indemnify TI and its representatives against any damages arising out of the use of TI products in such safety-critical applications.

TI products are neither designed nor intended for use in military/aerospace applications or environments unless the TI products are specifically designated by TI as military-grade or "enhanced plastic." Only products designated by TI as military-grade meet military specifications. Buyers acknowledge and agree that any such use of TI products which TI has not designated as military-grade is solely at the Buyer's risk, and that they are solely responsible for compliance with all legal and regulatory requirements in connection with such use.

TI products are neither designed nor intended for use in automotive applications or environments unless the specific TI products are designated by TI as compliant with ISO/TS 16949 requirements. Buyers acknowledge and agree that, if they use any non-designated products in automotive applications, TI will not be responsible for any failure to meet such requirements.

Following are URLs where you can obtain information on other Texas Instruments products and application solutions:

Products		Applications	
Amplifiers	amplifier.ti.com	Audio	www.ti.com/audio
Data Converters	dataconverter.ti.com	Automotive	www.ti.com/automotive
DSP	dsp.ti.com	Broadband	www.ti.com/broadband
Interface	interface.ti.com	Digital Control	www.ti.com/digitalcontrol
Logic	logic.ti.com	Military	www.ti.com/military
Power Mgmt	power.ti.com	Optical Networking	www.ti.com/opticalnetwork
Microcontrollers	microcontroller.ti.com	Security	www.ti.com/security
RFID	www.ti-rfid.com	Telephony	www.ti.com/telephony
Low Power Wireless	www.ti.com/lpw	Video & Imaging	www.ti.com/video
		Wireless	www.ti.com/wireless

Mailing Address: Texas Instruments, Post Office Box 655303, Dallas, Texas 75265
Copyright © 2007, Texas Instruments Incorporated

Looking for pricing, stock, or lifecycle information?

Click below to explore more details on WIN SOURCE:

- ⊖ [View ADS54RF63EVM](#) on WIN SOURCE
- ⊖ [Texas Instruments](#) Information

Optimize Your Supply Chain with WIN SOURCE Solutions

- ✓ Global Sourcing Solution
- ✓ Obsolete Management
- ✓ Cost Control Management
- ✓ Shortage Management
- ✓ Alternative Solution
- ✓ Excess Inventory Management