



**THE DATASHEET OF  
ABS25-32.768KHZ-4-T**



# 32.768 kHz LOW FREQUENCY SMD CRYSTAL



ABS25

Pb in High Temperature Solder  
(exempt 7(a) per 2015/863/EU Annex)

**RoHS**  
Compliant

## FEATURES:

- Plastic molded SMD
- 2.5mm height ideal for high density circuit boards
- Suitable for RoHS compliant reflow
- Extended temperature -40°C to +85°C for industrial applications

## APPLICATIONS:

- Wide range in communication & measuring equipment
- Commercial & Industrial applications
- Computer clock

## STANDARD SPECIFICATIONS:

Parameters	Minimum	Typical	Maximum	Units	Notes
Nominal Frequency	-----	32.768	-----	kHz	
Frequency Range	30	-----	100	kHz	Other frequencies
Operating Temperature	-40	-----	+85	°C	
Turnover Temperature	+20	+25	+30	°C	
Storage Temperature	-55	-----	+125	°C	
Frequency Tolerance @+25°C	-20	-----	+20	ppm	32.768kHz
	-30	-----	+30		Other frequencies
Capacitance Ratio (C0/C1)	-----	450	-----		32.768kHz
	-----	425 to 800	-----		Other frequencies
Frequency Coefficient (B)		-0.035±0.01		ppm/°C <sup>2</sup>	
Equivalent series resistance (R1)	-----	-----	50	kΩ	
Shunt capacitance (C0)	-----	1.35	-----	pF	32.768kHz
		0.8 to 1.7		pF	Other frequencies
Load capacitance (CL)		12.5		pF	See options
Drive Level	-----	-----	1	μW	
Aging @ 25°C±3°C (First year)	-3	-----	+3	ppm	32.768kHz
	-5	-----	+5		Other frequencies
Insulation Resistance	500	-----	-----	MΩ	@ 100Vdc ± 15V

## OPTIONS AND PART IDENTIFICATION:

(Left blank if standard)

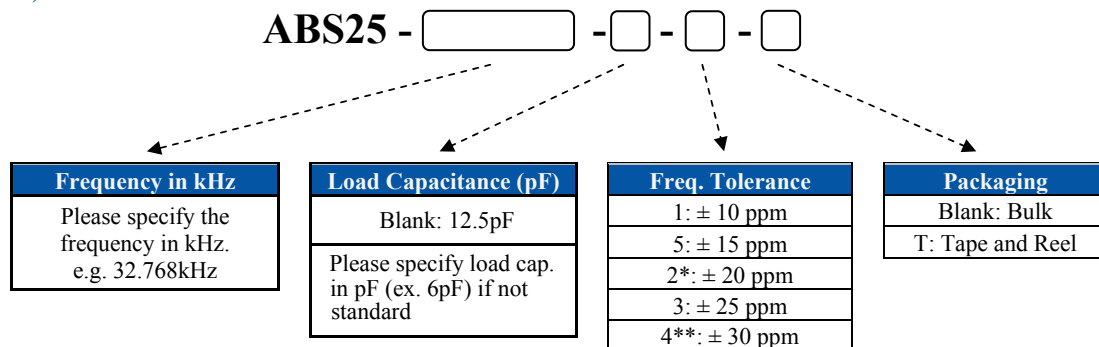

\*STD for 32.768kHz. Please leave this blank if F is 32.768kHz.

\*\*STD for other frequencies. Please leave this blank if F is not 32.768kHz.

# 32.768 kHz LOW FREQUENCY SMD CRYSTAL



ABS25

Pb in High Temperature Solder  
(exempt 7(a) per 2015/863/EU Annex)

**RoHS**  
Compliant

## OUTLINE DRAWING:

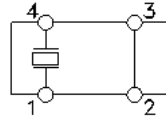
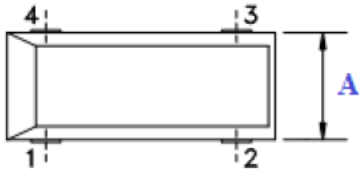

Electrode Arrangement  
Pin 2 and 3 are not connected to the GND (Floating)

## Recommended Land Pattern

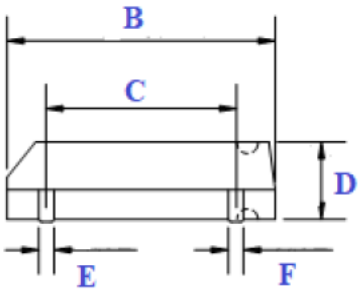
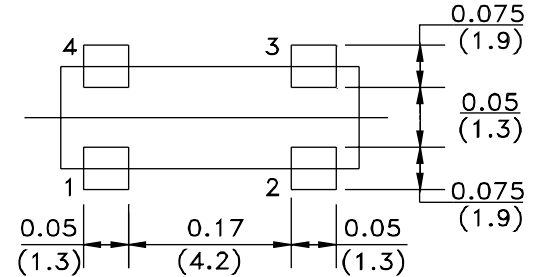

Dimension Table	
A	3.8 ± 0.2 MAX
B	8.4 MAX
C	5.5 ± 0.1
D	2.5 ± 0.1 MAX
E	0.5
F	0.5
G	0.9 Ref.



Dimensions: (inches) mm

## TAPE & REEL:

T = Tape and reel 3,000pcs/reel

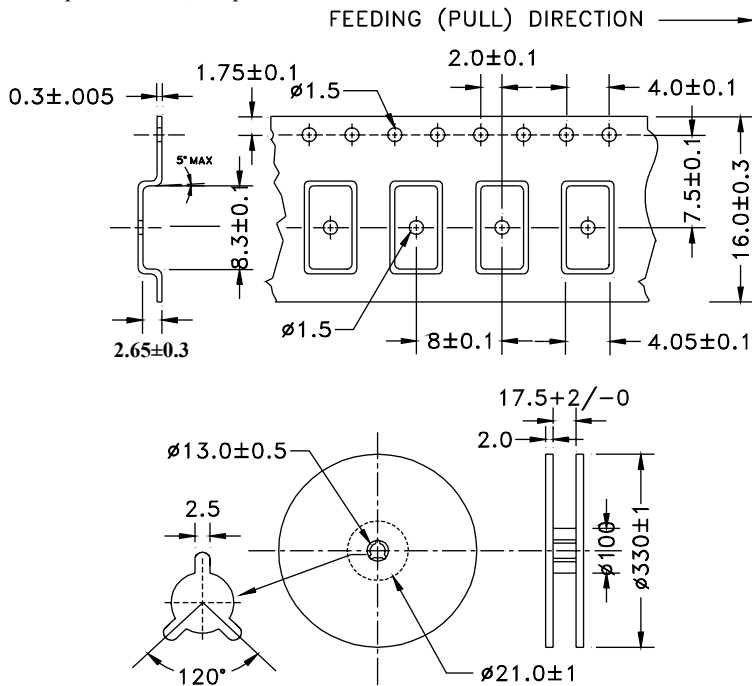

Dimensions: mm

## REFLOW PROFILE

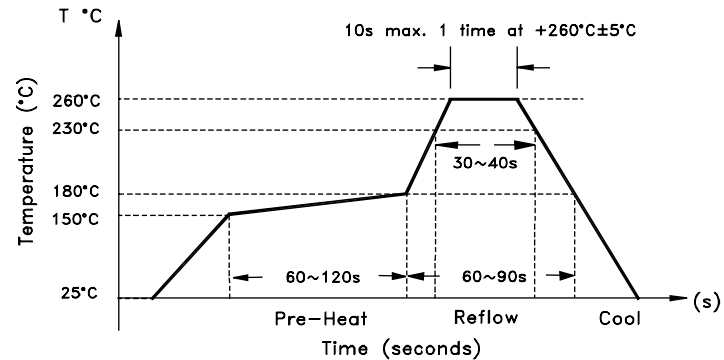

**ATTENTION:** Abracon LLC's products are COTS – Commercial-Off-The-Shelf products; suitable for Commercial, Industrial and, where designated, Automotive Applications. Abracon's products are not specifically designed for Military, Aviation, Aerospace, Life-dependent Medical applications or any application requiring high reliability where component failure could result in loss of life and/or property. For applications requiring high reliability and/or presenting an extreme operating environment, written consent and authorization from Abracon LLC is required. Please contact Abracon LLC for more information.

## Looking for pricing, stock, or lifecycle information?

Click below to explore more details on WIN SOURCE:

 [View ABS25-32.768KHZ-4-T on WIN SOURCE](#)

 [Abracon LLC Information](#)

## Optimize Your Supply Chain with WIN SOURCE Solutions

-  Global Sourcing Solution
-  Obsolete Management
-  Cost Control Management
-  Shortage Management
-  Alternative Solution
-  Excess Inventory Management