



**THE DATASHEET OF  
ABM2-20.000MHZ-D4Y-T**



# CERAMIC SMD MICROPROCESSOR CRYSTAL

ABM2

RoHS/RoHS II Compliant

RoHS/RoHS II compliant. Pb in glass (exempt 7(c) per 2015/863/EU Annex)



Typical 8.0 x 4.5 x 1.6mm

Moisture Sensitivity Level (MSL) – This product is Hermetically Sealed and not Moisture Sensitive -MSL = N/A: Not Applicable

## FEATURES:

- Low in height; suitable for thin equipment
- Glass sealed package assures high reliability and high temperature operation
- Tight tolerance and stability available
- Suitable for RoHS compliant reflow
- Low cost glass sealed crystal solution

## APPLICATIONS:

- High density applications
- Modems, communication and test equipment
- PCMCIA, Wireless applications
- Microprocessor crystals

## STANDARD SPECIFICATIONS:

Parameters	Minimum	Typical	Maximum	Units	Notes
FrequencyRange	8.000	-----	100.000	MHz	Fundamental
Operation mode	8.000	-----	40.000		Fundamental AT-cut (Standard)
	40.001	-----	100.000		3 <sup>rd</sup> OT AT -cut (Standard)
	40.001	-----	60.000		Fundamental AT-cut (See options)
Operating Temperature	-10	-----	+60	°C	See options
Storage Temperature	-40	-----	+85	°C	
Frequency Tolerance@ +25°C	-50	-----	+50	ppm	See options
Frequency Stability over the Operating Temperature ( ref. to +25°C)	-50	-----	+50	ppm	See options
Equivalent series resistance	-----	-----	100	Ω	8.000 – 10.000MHz (Fundamental)
	-----	-----	60		10.001 – 15.999MHz (Fundamental)
	-----	-----	50		16.000 – 60.000MHz (Fundamental)
	-----	-----	70		40.000 – 100.000MHz (3 <sup>rd</sup> OT)
Shunt capacitance (C0)	-----	-----	7	pF	-----
Load capacitance (CL)	-----	18	-----	pF	See options
Drive Level	-----	10	100	μW	
Aging @ 25°C ±3°C	-----	-----	±5	ppm	First year
Insulation Resistance	500	-----	-----	MΩ	@ 100Vdc

# CERAMIC SMD MICROPROCESSOR CRYSTAL

ABM2

RoHS/RoHS II Compliant

RoHS/RoHS II compliant. Pb in glass (exempt 7(c) per 2015/863/EU Annex)



Typical 8.0 x 4.5 x 1.6mm

## OPTIONS AND PART IDENTIFICATION: (Left blank if standard)

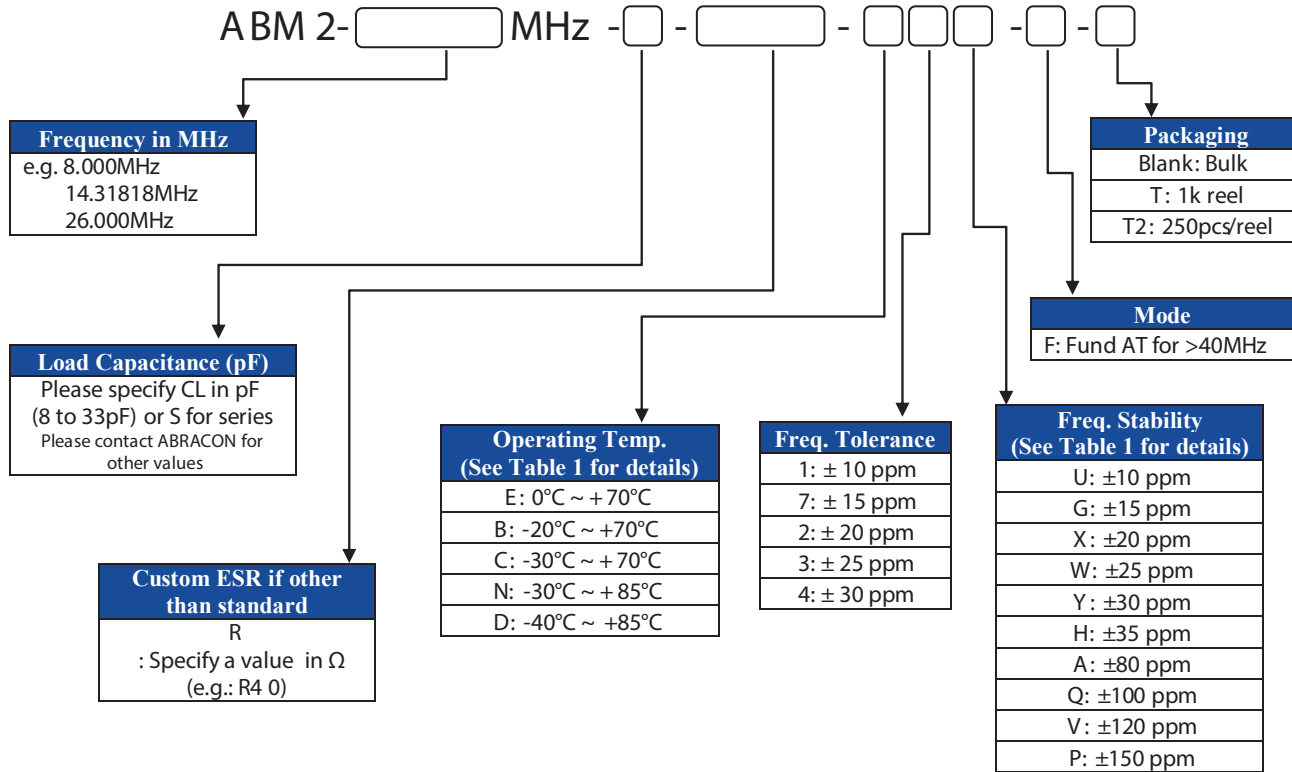

Note: See Table 1 for the availability of Operating Temp. and Freq. Stability combination

Table 1 Available Combinations of Operating Temp. and Freq. Stability

Operating Temp.	Freq. Stability					
	U:±10ppm	G:±15ppm	X:±20ppm	W:±25ppm	Y:±30ppm	H:±35ppm
Std: -10°C ~ +60°C	√	√	√	√	√	√
E: 0°C ~ +70°C		√	√	√	√	√
B: -20°C ~ +70°C		√	√	√	√	√
C: -30°C ~ +70°C				√	√	√
N: -30°C ~ +85°C					√	√
D: -40°C ~ +85°C					√*	√*

Operating Temp.	Freq. Stability				
	Std:±50ppm	A:±80ppm	Q:±100ppm	V:±120ppm	P:±150ppm
Std: -10°C ~ +60°C	√	√	√	√	√
E: 0°C ~ +70°C	√	√	√	√	√
B: -20°C ~ +70°C	√	√	√	√	√
C: -30°C ~ +70°C	√	√	√	√	√
N: -30°C ~ +85°C	√	√	√	√	√
D: -40°C ~ +85°C	√*	√	√	√	√

Note: \*: Availability depends on frequency.

# CERAMIC SMD MICROPROCESSOR CRYSTAL

ABM2

RoHS/RoHS II Compliant

RoHS/RoHS II compliant. Pb in glass (exempt 7(c) per 2015/863/EU Annex)



Typical 8.0 x 4.5 x 1.6mm

## OUTLINE DIMENSION:

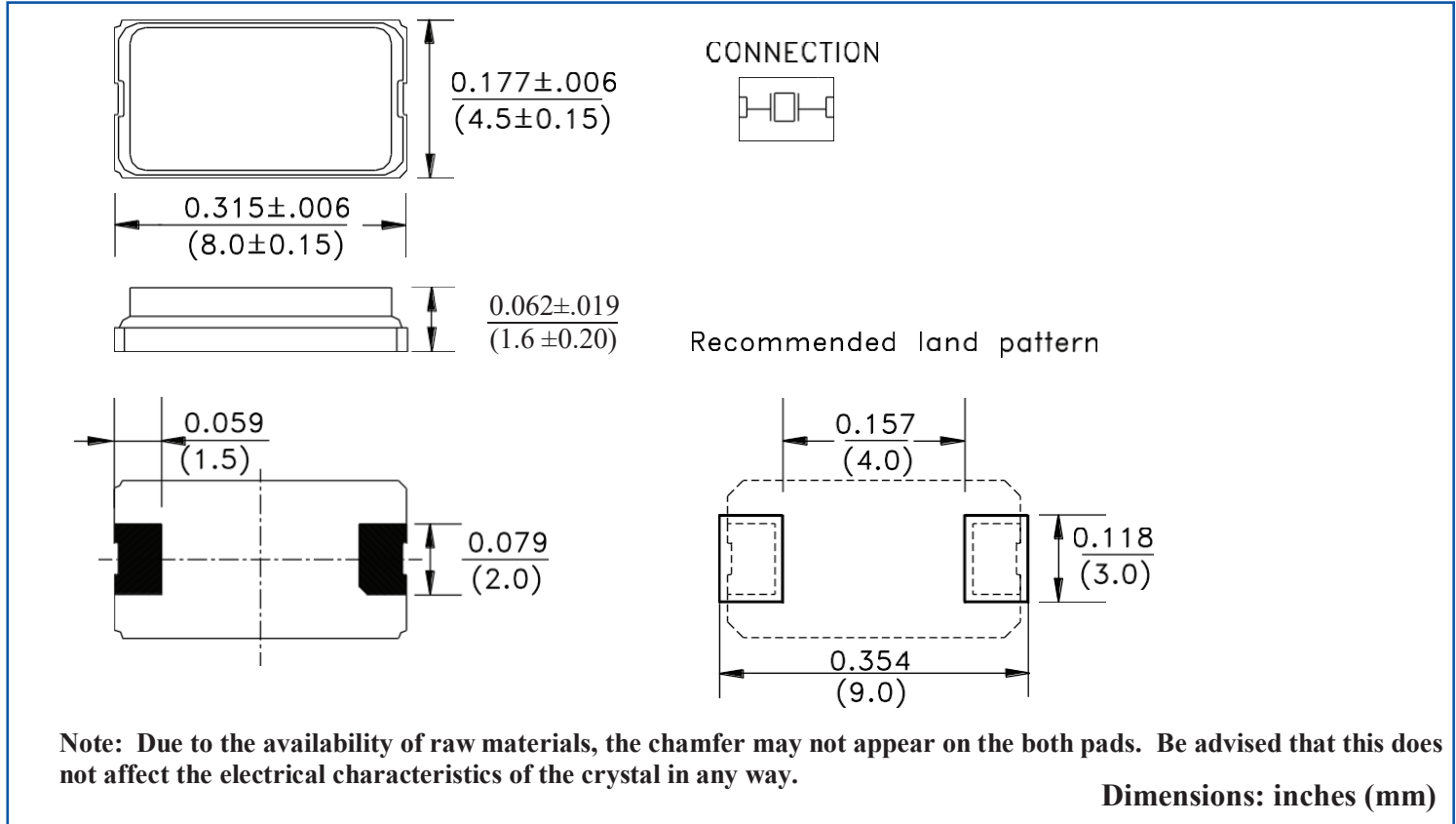

## REFLOW PROFILE:

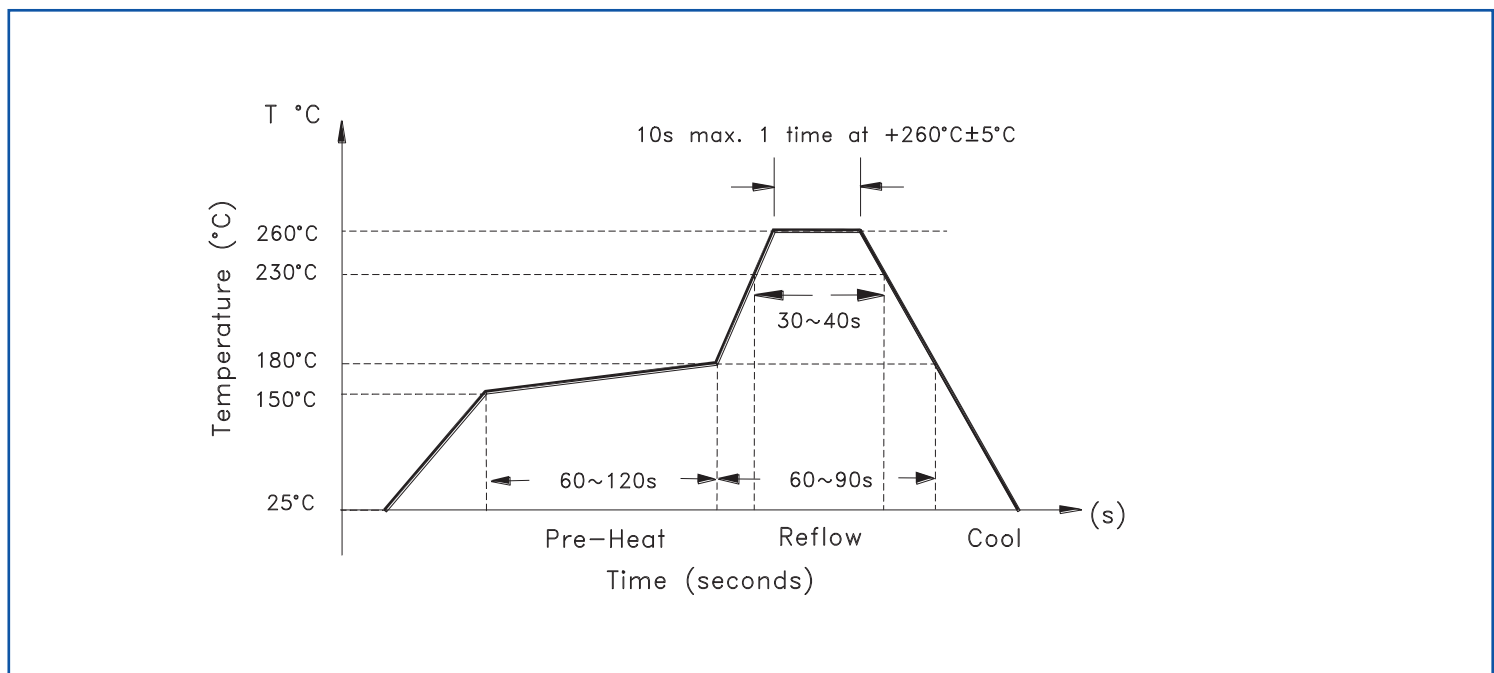

# CERAMIC SMD MICROPROCESSOR CRYSTAL

ABM2

RoHS/RoHS II Compliant

RoHS/RoHS II compliant. Pb in glass (exempt 7(c) per 2015/863/EU Annex)



Typical 8.0 x 4.5 x 1.6mm

## TAPE & REEL:

T: 1000pcs/reel

T2: 250pcs/reel

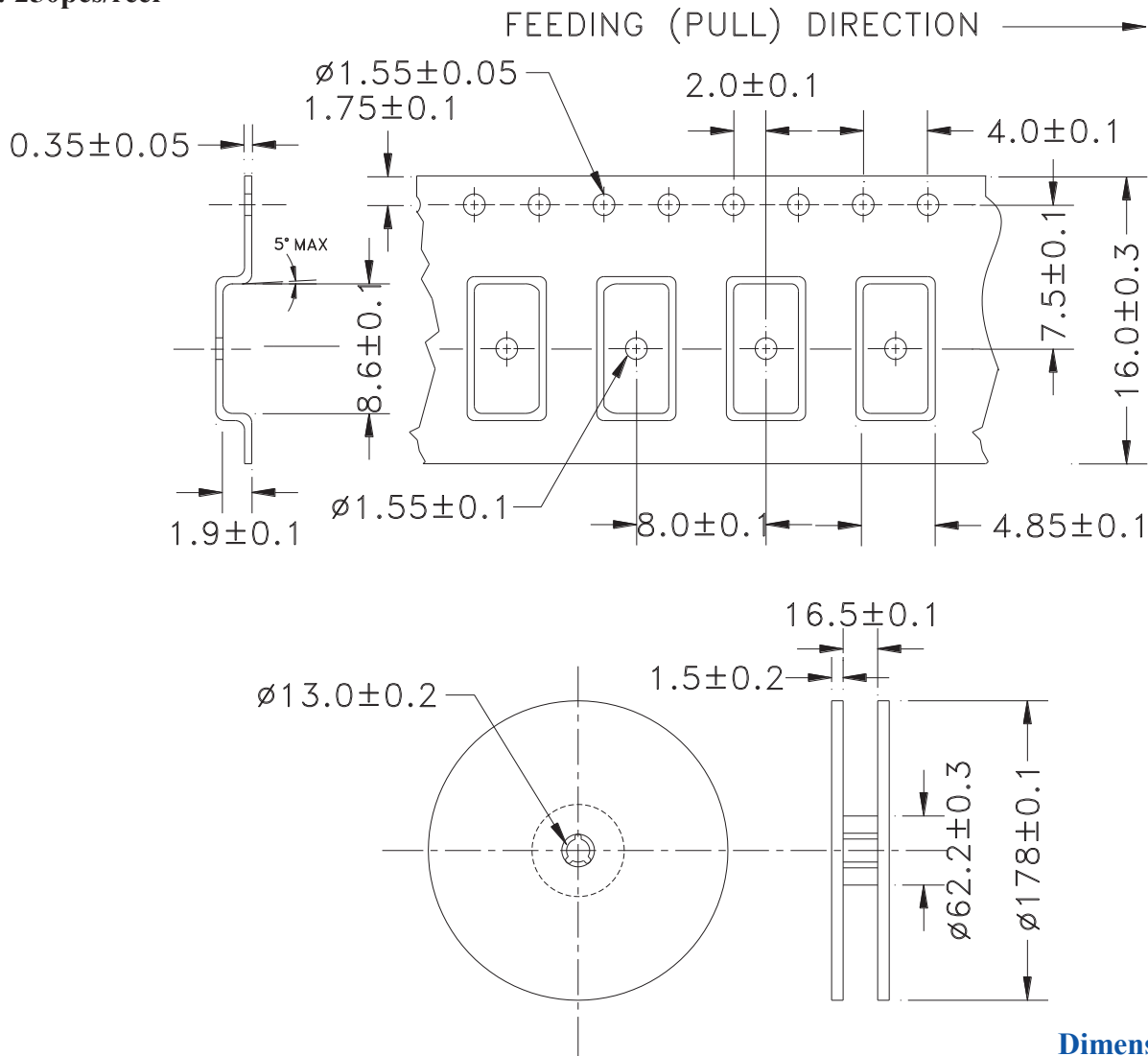

**ATTENTION:** Abracon LLC's products are COTS – Commercial-Off-The-Shelf products; suitable for Commercial, Industrial and, where designated, Automotive Applications. Abracon's products are not specifically designed for Military, Aviation, Aerospace, Life-dependent Medical applications or any application requiring high reliability where component failure could result in loss of life and/or property. For applications requiring high reliability and/or presenting an extreme operating environment, written consent and authorization from Abracon LLC is required. Please contact Abracon LLC for more information.

## Looking for pricing, stock, or lifecycle information?

Click below to explore more details on WIN SOURCE:

- ⊖ [View ABM2-20.000MHZ-D4Y-T on WIN SOURCE](#)
- ⊖ [Abracon LLC Information](#)

## Optimize Your Supply Chain with WIN SOURCE Solutions

- ✓ Global Sourcing Solution
- ✓ Obsolete Management
- ✓ Cost Control Management
- ✓ Shortage Management
- ✓ Alternative Solution
- ✓ Excess Inventory Management