

Overview

The KEMET Aluminum Organic Capacitor (AO-CAP) is a solid state aluminum capacitor. The cathode is a conductive organic polymer, which results in very low ESR and improved capacitance retention at high frequency. AO-CAPs may be operated at steady state voltages up to 100% of rated voltage without the need to de-rate.

Since there is no liquid electrolyte, the AO-CAP offers long operational lifetimes, low ESR, and high operational temperatures. The inherent low ESR renders the AO-CAP suitable for high ripple current handling. The small package size, high ripple current capability, high operating temperature, low parasitics, and high capacitance makes it ideal for high performance microprocessor, FPGA, and ASIC decoupling designs.

Benefits

- Low ESR: 3 – 70 mΩ
- Polymer cathode technology
- Plus performance grade with extended life up to 3,000 hours at 125°C
- High frequency capacitance retention
- Non-ignition failure mode
- 100% accelerated steady state aging
- 100% surge current tested
- Volumetric efficiency
- Self-healing mechanism
- EIA standard case sizes

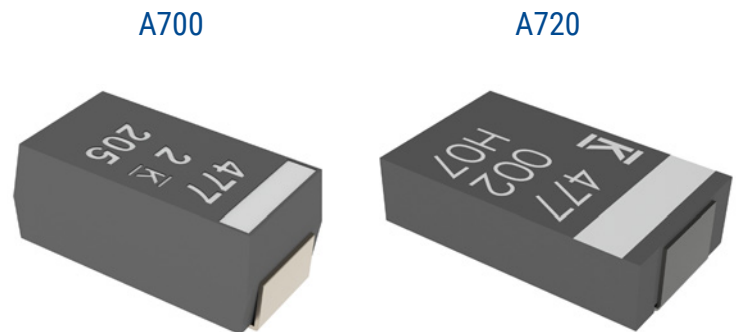

Applications

Typical applications include DC/DC converters, notebook PCs, telecommunications, displays, and industrial applications.

Environmental Compliance

- RoHS compliant when ordered with 100% Sn or Ni-Pd-Au
- Halogen-free
- Epoxy compliant with UL94 V-0

K-SIM

For a detailed analysis of specific part numbers, please visit <https://ksim.kemet.com/capacitor-simulation> to access KEMET's K-SIM software. KEMET K-SIM is designed to simulate behavior of components with respect to frequency, ambient temperature, and DC bias levels.

Ordering Information

| A | 700 | V | 476 | M | 006 | A | T | E018 | |
|-----------------|------------------------------------------------------------|-----------------------|----------------------------------------------------------------------------------------|-----------------------|-----------------------------------------------------------------------------------------------------------------------|---------------------|------------------------------------------------|-----------------------------------------------------------------|------------------------------------|
| Capacitor Class | Series | Case Size | Capacitance Code (pF) | Capacitance Tolerance | Rated Voltage (VDC) | Failure Rate/Design | Termination Finish | ESR Code | Packaging (C-Spec) |
| A = Aluminum | 700 = High Temperature 720 = Low ESR, Large capacitance | D Q V W X | First two digits represent significant figures. Third digit specifies number of zeros. | M = ±20% | 002 = 2 2R5 = 2.5 004 = 4 006 = 6.3 008 = 8 010 = 10 12R = 12.5 016 = 16 025 = 25 035 = 35 | A = N/A | T = 100% Matte Tin (Sn)-plated P = Ni-Pd-Au | E = ESR Last three digits specify ESR in mΩ (018 = 18 mΩ) | Blank = 7" Reel 7280 = 13" Reel |

Plus Performance

| A | 700 | V | 477 | M | 002 | P | T | E009 | |
|-----------------|------------------------|-----------|----------------------------------------------------------------------------------------|-----------------------|---------------------|--------------------------------------------------------|--------------------------------|----------------------------------------------------------------|------------------------------------|
| Capacitor Class | Series | Case Size | Capacitance Code (pF) | Capacitance Tolerance | Rated Voltage (VDC) | Failure Rate/Design | Termination Finish | ESR Code | Packaging (C-Spec) |
| A = Aluminum | 700 = Aluminum Polymer | V | First two digits represent significant figures. Third digit specifies number of zeros. | M = ±20% | 002 = 2 | P = Plus Performance (Extended Life 3,000 hours/125°C) | T = 100% Matte Tin (Sn)-plated | E = ESR Last three digits specify ESR in mΩ (009 = 9 mΩ) | Blank = 7" Reel 7280 = 13" Reel |

Performance Characteristics

| Item | Performance Characteristics |
|-------------------------|--------------------------------------------------------------------------------------------------------------------------------------------------------------------------------------------------------------------------------------------------------------------------------------------------------------------------------------------------------------------------------------------------------------------|
| Operating Temperature | -55°C to 105°C/125°C (Refer to part number for maximum temperature rating) |
| Rated Capacitance Range | 6.8 – 560 µF at 120 Hz/25°C |
| Capacitance Tolerance | M Tolerance (20%) |
| Rated Voltage Range | 2 – 35 V |
| DF (120 Hz) | 6% |
| ESR (100 kHz) | Refer to Part Number Electrical Specification Table |
| Leakage Current | Refer to Part Number Electrical Specification Table If there is any concern about leakage current, please perform pre-conditioning to the part following below conditions: * Temperature: 105°C maximum * Voltage: Rated Voltage * Series Resistor: 1,000 Ω * Charge Time: 1 hour minimum * Measuring: Discharge the capacitor(s), store them for 4 to 24 hours at room temperature and RH ≤ 60% |

Qualification

| Test | Condition | Characteristics | | | | |
|--------------------------------|-----------------------------------------------------------------------------------------------------------------|-----------------|---------------------------------------|-------------------------------------|-------|--------------|
| Endurance | 105°C/125°C*2 at rated voltage, 2,000 hours*3 | Δ C/C | Within ±10%*4 of initial value | | | |
| | | DF | ≤ initial limit | | | |
| | | DCL | Within 1.25 x initial limit | | | |
| | | ESR | Within 2.0 x initial limit | | | |
| Storage Life | 105°C/125°C*2 at 0 volts, 2,000 hours*3 | Δ C/C | Within ±10%*4 of initial value | | | |
| | | DF | Within initial limits | | | |
| | | DCL | Within 1.25 x initial limit | | | |
| | | ESR | Within 2.0 x initial limit | | | |
| Endurance Extended | A700 Plus Performance 125°C at rated voltage, 3,000 hours | Δ C/C | Within ±30% | | | |
| | | DF | Within 2.0 x initial limit | | | |
| | | DCL | Within 1.25 x initial limit | | | |
| | | ESR | Within 2.0 x initial limit | | | |
| Storage Life Extended | A700 Plus Performance 125°C at 0 Volts, 3,000 hours | Δ C/C | Within ±30% | | | |
| | | DF | Within 2.0 x initial limit | | | |
| | | DCL | Within 1.25 x initial limit | | | |
| | | ESR | Within 2.0 x initial limit | | | |
| Humidity | 60°C, 90% RH, 500 hours, rated voltage 60°C, 90% RH, 500 hours, no load | Δ C/C | A700 parts | A720 parts | | |
| | | | Within -5/+30% *5 of initial value | Within -20/+50% of initial value | | |
| | | DCL | Within 5.0 x initial limit | | | |
| Temperature Stability | Extreme temperature exposure at a succession of continuous steps at +25°C, -55°C, +85°C, +105°C/+125°C*2 | Δ C/C | +25°C | -55°C | +85°C | +105°C/125°C |
| | | DF | IL*1 | ±15% | ±15% | ±20% |
| | | DCL | IL | IL | IL | IL |
| Surge Voltage | 105°C / 125°C*2, 1.32 x rated voltage, 33 Ω resistance, 1,000 cycles | Δ C/C | Within ±10%*4 of initial value | | | |
| | | DF | Within initial limits | | | |
| | | DCL | Within initial limits | | | |
| | | ESR | Within initial limits | | | |
| Mechanical Shock/ Vibration | Mil-Std-202, Meth. 213, Cond. I, 100 G Peak Mil-Std-202, Meth. 204, Cond. D, 10 Hz to 2,000 Hz, 20 G Peak | Δ C/C | Within ±10% of initial value | | | |
| | | DF | Within initial limits | | | |
| | | DCL | Within initial limits | | | |

*1 IL = Initial Limit

*2 Refer to part number specifications for individual temperature classification.

*3 Please look at the part numbers table for the endurance time specification.

*4 Capacitance change is ±20% for: A700W227M002AT, A700W227M2R5AT, A700Q227M002AT, A700Q227M2R5AT, A700V337M002AT, A700V337M2R5AT, A700V477M002AT, A700V477M2R5AT and for A720 > 16 V parts.

*5 Capacitance change is within -30/+70% of initial value for PN's : A700W227M002AT, A700W227M2R5AT, A700Q227M002AT, A700Q227M2R5AT, A700V337M002AT, A700V337M2R5AT, A700V477M002AT.

Electrical Characteristics A700

ESR vs. Frequency

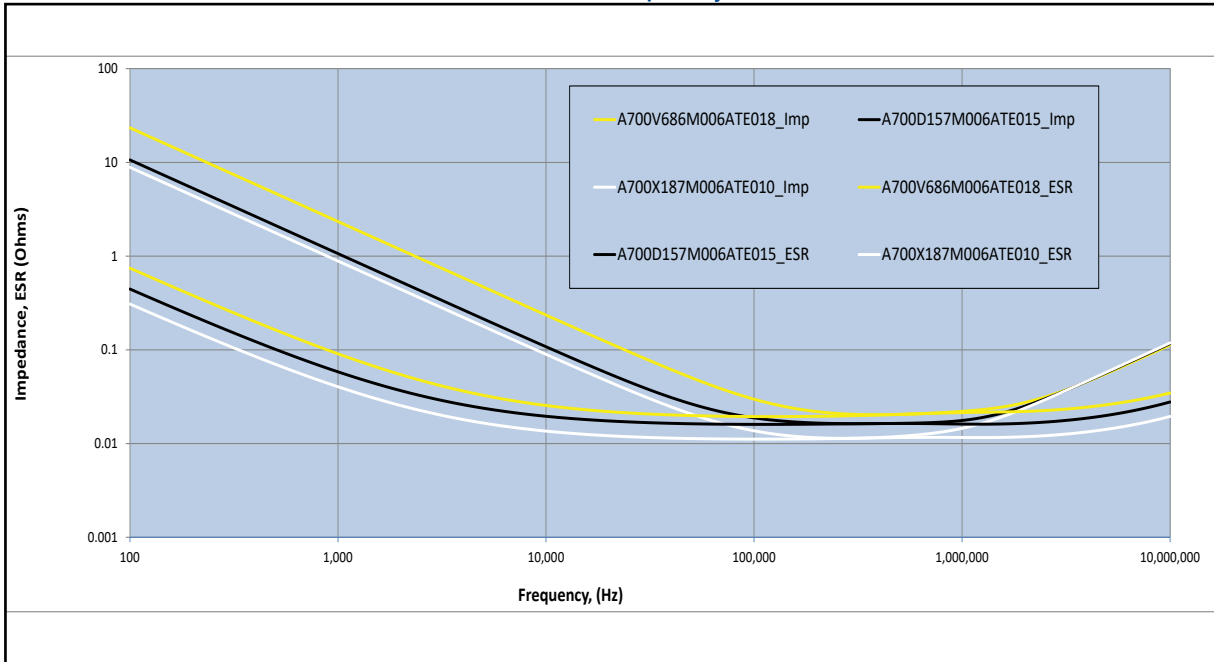

Capacitance vs. Frequency

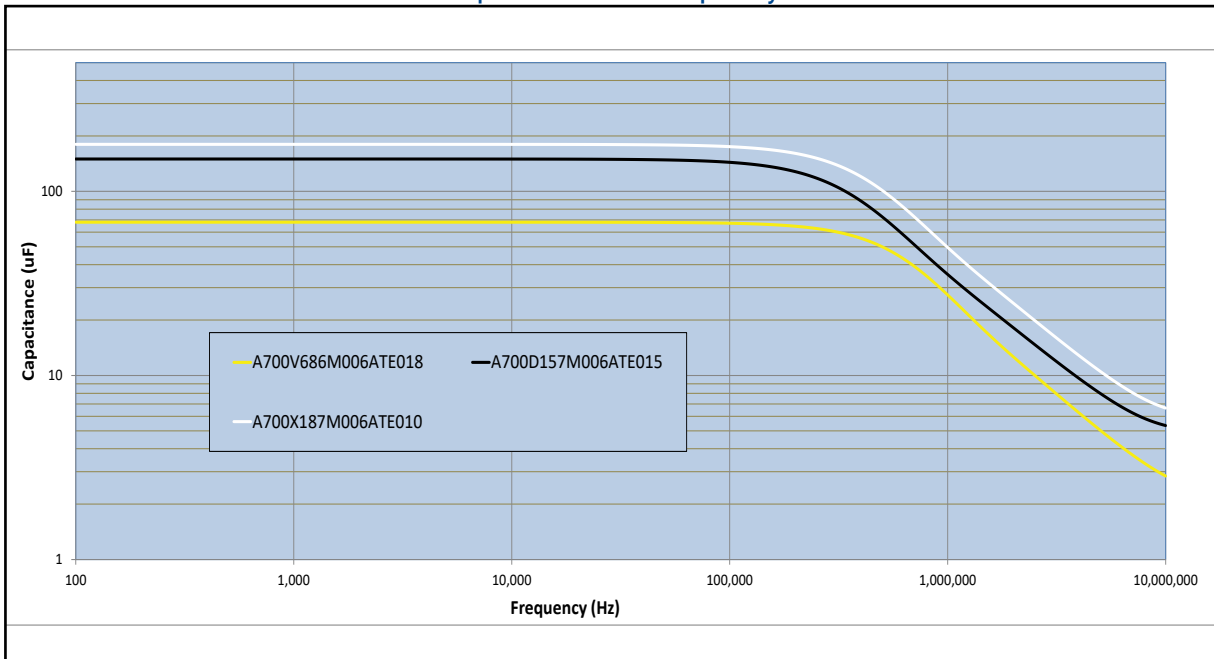

Electrical Characteristics A720

ESR vs. Frequency

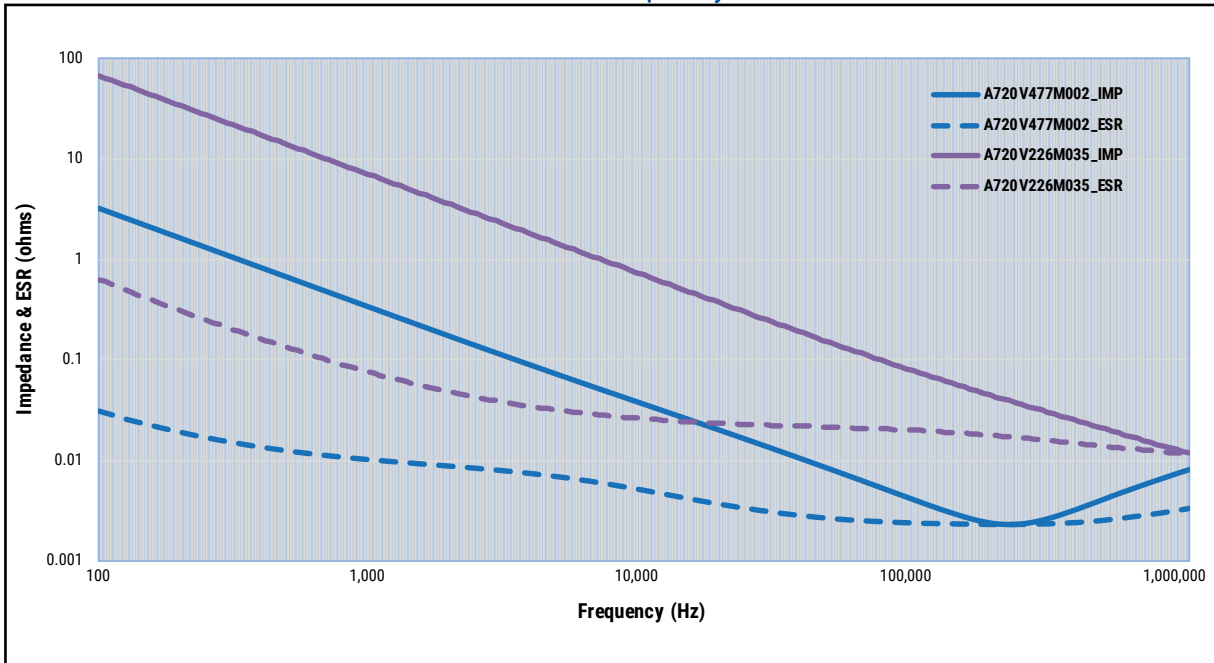

Capacitance vs. Frequency

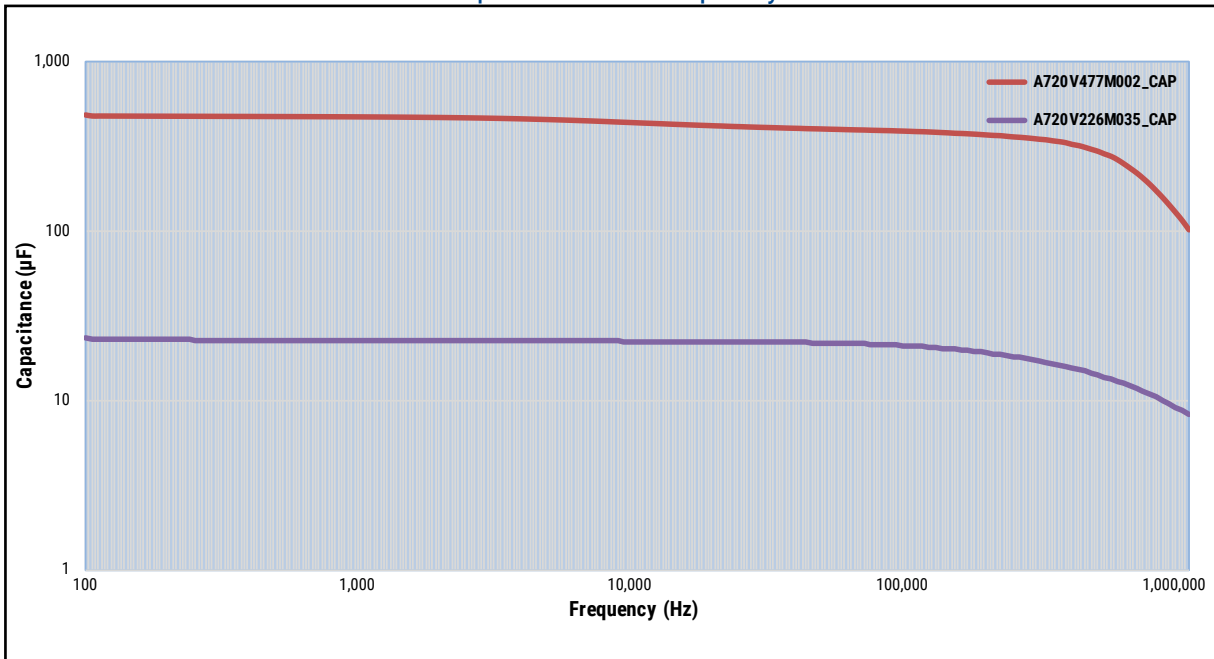

Dimensions – Millimeters (Inches)

Metric will govern

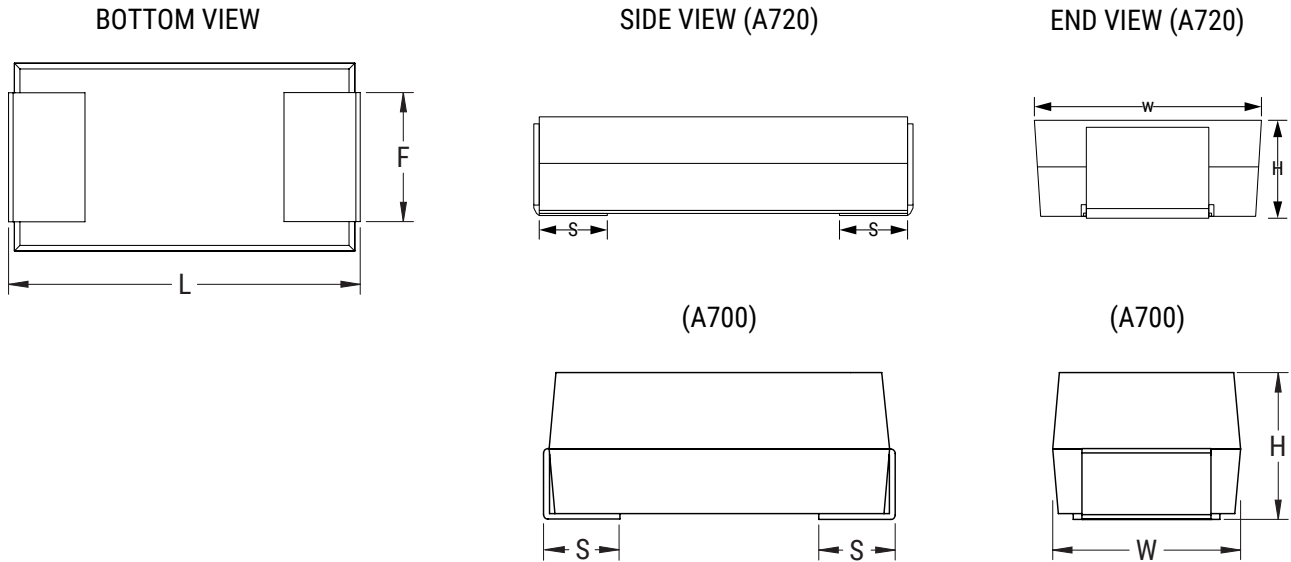

*Glue pad shape is at KEMET's option

| Case Size | | Component | | | | | Typical Weight |
|-----------|---------|--------------------------------------|--------------------------------------|--------------------------------------|-----------------------------|-----------------------------|-------------------------------|
| KEMET | EIA | L | W | H | $F \pm 0.1$ $\pm(0.004)$ | $S \pm 0.3$ $\pm(0.012)$ | (mg) |
| D | 7343-31 | 7.3 ± 0.3 (0.287 ± 0.012) | 4.3 ± 0.3 (0.169 ± 0.012) | 2.8 ± 0.3 (0.110 ± 0.012) | 2.4 (0.094) | 1.3 (0.051) | 196.58 |
| V | 7343-20 | 7.3 ± 0.3 (0.287 ± 0.012) | 4.3 ± 0.3 (0.169 ± 0.012) | 2.0 (0.079) Maximum * | 2.4 (0.094) | 1.3 (0.051) | 132.72 (A700) / 141 (A720) |
| W | 7343-15 | 7.3 ± 0.3 (0.287 ± 0.012) | 4.3 ± 0.3 (0.169 ± 0.012) | 1.4 ± 0.1 (0.055 ± 0.004) | 2.4 (0.094) | 1.3 (0.051) | 305.03 |
| Q | 7343-12 | 7.3 ± 0.3 (0.287 ± 0.012) | 4.3 ± 0.3 (0.169 ± 0.012) | 1.1 ± 0.1 (0.043 ± 0.004) | 2.4 (0.094) | 1.3 (0.051) | - |
| X | 7343-43 | 7.3 ± 0.3 (0.287 ± 0.012) | 4.3 ± 0.3 (0.169 ± 0.012) | 4.0 ± 0.3 (0.157 ± 0.012) | 2.4 (0.094) | 1.3 (0.051) | 305.03 |

Notes: (Ref) – Dimensions provided for reference only.

* Maximum Height is 2.1 for the part numbers : A700V337M002AT, A700V477M002AT, A700V477M002PT, A700V337M2R5AT, A700V477M2R5AT and A720 parts

Table 3 – Ratings & Part Number Reference

| Rated Voltage | Rated Capacitance | Case Code/ Case Size | KEMET Part Number | DC Leakage | DF | ESR | Ripple Current (rms) | Endurance | MSL | Maximum Operating Temp. |
|----------------------------|-------------------|----------------------|------------------------------|--------------------------------|---------------------------|----------------------------|------------------------------------------------|-----------|---------------------|-------------------------|
| (V) | µF | KEMET/EIA | (See below for part options) | µA at +25°C Maximum/ 5 Minutes | % at +25°C 120 Hz Maximum | mΩ at 25°C 100 kHz Maximum | mA at 100 kHz with/T = +20°C at -55°C to 125°C | (Hours) | Reflow Temp ≤ 260°C | °C |
| 105°C | | | | | | | | | | |
| 2 | 220 | Q/7343-12 | A700Q227M002ATE009 | 44 | 6 | 9 | 5,900 | 2,000 | 3 | 105 |
| 2 | 220 | W/7343-15 | A700W227M002ATE006 | 26 | 6 | 6 | 6,900 | 2,000 | 3 | 105 |
| 2 | 220 | W/7343-15 | A700W227M002ATE009 | 26 | 6 | 9 | 5,700 | 2,000 | 3 | 105 |
| 2 | 330 | V/7343-21 | A720V337M002APE003 | 39.6 | 6 | 3 | 11,690 | 2,000 | 3 | 105 |
| 2 | 470 | V/7343-21 | A720V477M002APE006 | 56 | 6 | 6 | 8,260 | 2,000 | 3 | 105 |
| 2 | 470 | V/7343-21 | A720V477M002APE4R5 | 56 | 6 | 4.5 | 9,540 | 2,000 | 3 | 105 |
| 2 | 470 | V/7343-21 | A720V477M002APE003 | 56 | 6 | 3 | 11,690 | 2,000 | 3 | 105 |
| 2 | 560 | V/7343-21 | A720V567M002APE003 | 67 | 6 | 3 | 11,690 | 2,000 | 3 | 105 |
| 2 | 560 | V/7343-21 | A720V567M002APE4R5 | 67 | 6 | 4.5 | 9,540 | 2,000 | 3 | 105 |
| 2 | 560 | V/7343-21 | A720V567M002APE006 | 67 | 6 | 6 | 8,260 | 2,000 | 3 | 105 |
| 2.5 | 220 | Q/7343-12 | A700Q227M2R5ATE009 | 55 | 6 | 9 | 5,900 | 2,000 | 3 | 105 |
| 2.5 | 220 | W/7343-15 | A700W227M2R5ATE006 | 33 | 6 | 6 | 6,900 | 2,000 | 3 | 105 |
| 2.5 | 220 | W/7343-15 | A700W227M2R5ATE009 | 33 | 6 | 9 | 5,700 | 2,000 | 3 | 105 |
| 2.5 | 330 | V/7343-21 | A720V337M2R5APE003 | 50 | 6 | 3 | 11,690 | 2,000 | 3 | 105 |
| 2.5 | 470 | V/7343-21 | A700V477M2R5ATE4R5 | 70.5 | 6 | 4.5 | 7,750 | 2,000 | 3 | 105 |
| 2.5 | 470 | V/7343-21 | A700V477M2R5ATE006 | 70.5 | 6 | 6 | 6,700 | 2,000 | 3 | 105 |
| 2.5 | 470 | V/7343-21 | A700V477M2R5ATE009 | 70.5 | 6 | 9 | 5,480 | 2,000 | 3 | 105 |
| 2.5 | 470 | V/7343-21 | A720V477M2R5APE4R5 | 70.5 | 6 | 4.5 | 9,540 | 2,000 | 3 | 105 |
| 2.5 | 470 | V/7343-21 | A720V477M2R5APE003 | 70.5 | 6 | 3 | 11,690 | 2,000 | 3 | 105 |
| 2.5 | 560 | V/7343-21 | A720V567M2R5APE003 | 84 | 6 | 3 | 11,690 | 2,000 | 3 | 105 |
| 2.5 | 560 | V/7343-21 | A720V567M2R5APE4R5 | 84 | 6 | 4.5 | 9,540 | 2,000 | 3 | 105 |
| 2.5 | 560 | V/7343-21 | A720V567M2R5APE006 | 84 | 6 | 6 | 8,260 | 2,000 | 3 | 105 |
| 4 | 330 | V/7343-21 | A720V337M004APE006 | 79 | 6 | 6 | 8,260 | 2,000 | 3 | 105 |
| 4 | 330 | V/7343-21 | A720V337M004APE4R5 | 79 | 6 | 4.5 | 9,540 | 2,000 | 3 | 105 |
| 4 | 330 | V/7343-21 | A720V337M004APE003 | 79 | 6 | 3 | 11,690 | 2,000 | 3 | 105 |
| 16 | 100 | V/7343-21 | A720V107M016APE040 | 160 | 6 | 40 | 3,200 | 2,000 | 3 | 105 |
| 16 | 100 | V/7343-21 | A720V107M016APE025 | 160 | 6 | 25 | 4,000 | 2,000 | 3 | 105 |
| 16 | 100 | V/7343-21 | A720V107M016APE015 | 160 | 6 | 15 | 5,200 | 2,000 | 3 | 105 |
| 16 | 100 | V/7343-21 | A720V107M016APE010 | 160 | 6 | 10 | 6,400 | 2,000 | 3 | 105 |
| 35 | 22 | V/7343-21 | A720V226M035APE040 | 77 | 6 | 40 | 3,200 | 2,000 | 3 | 105 |
| 125°C / 1000 Hrs endurance | | | | | | | | | | |
| 2 | 330 | V/7343-21 | A700V337M002ATE4R5 | 40 | 6 | 4.5 | 7,750 | 1,000 | 3 | 125 |
| 2 | 330 | V/7343-21 | A700V337M002ATE006 | 40 | 6 | 6 | 6,700 | 1,000 | 3 | 125 |
| 2 | 330 | V/7343-21 | A700V337M002ATE009 | 40 | 6 | 9 | 5,500 | 1,000 | 3 | 125 |
| 2.5 | 330 | V/7343-21 | A700V337M2R5ATE4R5 | 50 | 6 | 4.5 | 7,750 | 1,000 | 3 | 125 |
| 2.5 | 330 | V/7343-21 | A700V337M2R5ATE006 | 50 | 6 | 6 | 6,700 | 1,000 | 3 | 125 |
| 2.5 | 330 | V/7343-21 | A700V337M2R5ATE009 | 50 | 6 | 9 | 5,500 | 1,000 | 3 | 125 |
| 125°C / 2000 Hrs endurance | | | | | | | | | | |
| 2 | 100 | V/7343-20 | A700V107M002ATE016 | 12 | 6 | 16 | 4,100 | 2,000 | 3 | 125 |
| 2 | 100 | V/7343-20 | A700V107M002ATE018 | 12 | 6 | 18 | 3,900 | 2,000 | 3 | 125 |
| 2 | 100 | V/7343-20 | A700V107M002ATE025 | 12 | 6 | 25 | 3,300 | 2,000 | 3 | 125 |
| 2 | 100 | V/7343-20 | A700V107M002ATE028 | 12 | 6 | 28 | 3,100 | 2,000 | 3 | 125 |
| 2 | 150 | V/7343-20 | A700V157M002ATE015 | 18 | 6 | 15 | 4,200 | 2,000 | 3 | 125 |
| 2 | 150 | V/7343-20 | A700V157M002ATE018 | 18 | 6 | 18 | 3,900 | 2,000 | 3 | 125 |
| 2 | 150 | V/7343-20 | A700V157M002ATE025 | 18 | 6 | 25 | 3,300 | 2,000 | 3 | 125 |
| 2 | 150 | V/7343-20 | A700V157M002ATE028 | 18 | 6 | 28 | 3,100 | 2,000 | 3 | 125 |
| 2 | 180 | D/7343-31 | A700D187M002ATE015 | 22 | 6 | 15 | 4,100 | 2,000 | 3 | 125 |
| 2 | 180 | D/7343-31 | A700D187M002ATE018 | 22 | 6 | 18 | 3,700 | 2,000 | 3 | 125 |
| 2 | 220 | V/7343-20 | A700V227M002ATE009 | 26 | 6 | 9 | 5,500 | 2,000 | 3 | 125 |
| (V) | µF | KEMET/EIA | (See below for part options) | µA at +25°C Maximum/ 5 Minutes | % at +25°C 120 Hz Maximum | mΩ at 25°C 100 kHz Maximum | mA at 100 kHz with/T = +20°C at -55°C to 125°C | (Hours) | Reflow Temp ≤ 260°C | °C |
| Rated Voltage | Rated Capacitance | Case Code/ Case Size | KEMET Part Number | DC Leakage | DF | ESR | Ripple Current | Endurance | MSL | Maximum Operating Temp. |

Higher voltage ratings and tighter tolerance product including ESR may be substituted within the same size at KEMET's option. Voltage substitutions will be marked with the higher voltage rating. Substitutions can include better than series.

Table 3 – Ratings & Part Number Reference cont.

| Rated Voltage | Rated Capacitance | Case Code/ Case Size | KEMET Part Number | DC Leakage | DF | ESR | Ripple Current (rms) | Endurance | MSL | Maximum Operating Temp. |
|---------------|-------------------|-------------------------|------------------------------|-----------------------------------|---------------------------|----------------------------|------------------------------------------------|-----------|---------------------|-------------------------|
| (V) | µF | KEMET/EIA | (See below for part options) | µA at +25°C Maximum/ 5 Minutes | % at +25°C 120 Hz Maximum | mΩ at 25°C 100 kHz Maximum | mA at 100 kHz with/T = +20°C at -55°C to 125°C | (Hours) | Reflow Temp ≤ 260°C | °C |
| 2 | 220 | V/7343-20 | A700V227M002ATE015 | 26 | 6 | 15 | 4,200 | 2,000 | 3 | 125 |
| 2 | 220 | V/7343-20 | A700V227M002ATE018 | 26 | 6 | 18 | 3,900 | 2,000 | 3 | 125 |
| 2 | 220 | D/7343-31 | A700D227M002ATE009 | 26 | 6 | 9 | 5,300 | 2,000 | 3 | 125 |
| 2 | 220 | D/7343-31 | A700D227M002ATE012 | 26 | 6 | 12 | 4,600 | 2,000 | 3 | 125 |
| 2 | 220 | D/7343-31 | A700D227M002ATE015 | 26 | 6 | 15 | 4,100 | 2,000 | 3 | 125 |
| 2 | 220 | D/7343-31 | A700D227M002ATE018 | 26 | 6 | 18 | 3,700 | 2,000 | 3 | 125 |
| 2 | 270 | X/7343-43 | A700X277M002ATE010 | 32 | 6 | 10 | 4,700 | 2,000 | 3 | 125 |
| 2 | 270 | X/7343-43 | A700X277M002ATE012 | 32 | 6 | 12 | 4,300 | 2,000 | 3 | 125 |
| 2 | 270 | X/7343-43 | A700X277M002ATE015 | 32 | 6 | 15 | 3,900 | 2,000 | 3 | 125 |
| 2 | 330 | D/7343-31 | A700D337M002ATE007 | 40 | 6 | 7 | 6,000 | 2,000 | 3 | 125 |
| 2 | 330 | D/7343-31 | A700D337M002ATE009 | 40 | 6 | 9 | 5,300 | 2,000 | 3 | 125 |
| 2 | 330 | D/7343-31 | A700D337M002ATE012 | 40 | 6 | 12 | 4,600 | 2,000 | 3 | 125 |
| 2 | 330 | X/7343-43 | A700X337M002ATE010 | 40 | 6 | 10 | 4,700 | 2,000 | 3 | 125 |
| 2 | 330 | X/7343-43 | A700X337M002ATE015 | 40 | 6 | 15 | 3,900 | 2,000 | 3 | 125 |
| 2 | 390 | X/7343-43 | A700X397M002ATE010 | 47 | 6 | 10 | 4,700 | 2,000 | 3 | 125 |
| 2 | 390 | X/7343-43 | A700X397M002ATE015 | 47 | 6 | 15 | 3,900 | 2,000 | 3 | 125 |
| 2 | 470 | V/7343-21 | A700V477M002ATE4R5 | 56 | 6 | 4.5 | 7,750 | 2,000 | 3 | 125 |
| 2 | 470 | V/7343-21 | A700V477M002ATE006 | 56 | 6 | 6 | 6,700 | 2,000 | 3 | 125 |
| 2 | 470 | V/7343-21 | A700V477M002ATE009 | 56 | 6 | 9 | 5,500 | 2,000 | 3 | 125 |
| 2 | 470 | D/7343-31 | A700D477M002ATE005 | 56 | 6 | 5 | 7,100 | 2,000 | 3 | 125 |
| 2 | 470 | D/7343-31 | A700D477M002ATE006 | 56 | 6 | 6 | 6,500 | 2,000 | 3 | 125 |
| 2 | 470 | X/7343-43 | A700X477M002ATE005 | 56 | 6 | 5 | 6,700 | 2,000 | 3 | 125 |
| 2 | 470 | X/7343-43 | A700X477M002ATE007 | 56 | 6 | 7 | 5,700 | 2,000 | 3 | 125 |
| 2 | 470 | X/7343-43 | A700X477M002ATE010 | 56 | 6 | 10 | 4,700 | 2,000 | 3 | 125 |
| 2 | 470 | X/7343-43 | A700X477M002ATE015 | 56 | 6 | 15 | 3,900 | 2,000 | 3 | 125 |
| 2 | 560 | X/7343-43 | A700X567M002ATE4R5 | 67 | 6 | 4.5 | 7,000 | 2,000 | 3 | 125 |
| 2 | 560 | X/7343-43 | A700X567M002ATE005 | 67 | 6 | 5 | 6,700 | 2,000 | 3 | 125 |
| 2 | 560 | X/7343-43 | A700X567M002ATE006 | 67 | 6 | 6 | 6,100 | 2,000 | 3 | 125 |
| 2 | 560 | X/7343-43 | A700X567M002ATE009 | 67 | 6 | 9 | 5,000 | 2,000 | 3 | 125 |
| 2.5 | 68 | V/7343-20 | A700V686M2R5ATE020 | 10 | 6 | 20 | 3,700 | 2,000 | 3 | 125 |
| 2.5 | 68 | V/7343-20 | A700V686M2R5ATE028 | 10 | 6 | 28 | 3,100 | 2,000 | 3 | 125 |
| 2.5 | 82 | V/7343-20 | A700V826M2R5ATE018 | 12 | 6 | 18 | 3,900 | 2,000 | 3 | 125 |
| 2.5 | 82 | V/7343-20 | A700V826M2R5ATE025 | 12 | 6 | 25 | 3,300 | 2,000 | 3 | 125 |
| 2.5 | 82 | V/7343-20 | A700V826M2R5ATE028 | 12 | 6 | 28 | 3,100 | 2,000 | 3 | 125 |
| 2.5 | 100 | D/7343-31 | A700D107M2R5ATE018 | 15 | 6 | 18 | 3,700 | 2,000 | 3 | 125 |
| 2.5 | 100 | D/7343-31 | A700D107M2R5ATE025 | 15 | 6 | 25 | 3,200 | 2,000 | 3 | 125 |
| 2.5 | 100 | D/7343-31 | A700D107M2R5ATE028 | 15 | 6 | 28 | 3,000 | 2,000 | 3 | 125 |
| 2.5 | 120 | D/7343-31 | A700D127M2R5ATE015 | 18 | 6 | 15 | 4,100 | 2,000 | 3 | 125 |
| 2.5 | 120 | D/7343-31 | A700D127M2R5ATE018 | 18 | 6 | 18 | 3,700 | 2,000 | 3 | 125 |
| 2.5 | 150 | D/7343-31 | A700D157M2R5ATE015 | 23 | 6 | 15 | 4,100 | 2,000 | 3 | 125 |
| 2.5 | 150 | D/7343-31 | A700D157M2R5ATE018 | 23 | 6 | 18 | 3,700 | 2,000 | 3 | 125 |
| 2.5 | 180 | D/7343-31 | A700D187M2R5ATE015 | 27 | 6 | 15 | 4,100 | 2,000 | 3 | 125 |
| 2.5 | 180 | D/7343-31 | A700D187M2R5ATE018 | 27 | 6 | 18 | 3,700 | 2,000 | 3 | 125 |
| 2.5 | 180 | X/7343-43 | A700X187M2R5ATE010 | 27 | 6 | 10 | 4,700 | 2,000 | 3 | 125 |
| 2.5 | 180 | X/7343-43 | A700X187M2R5ATE015 | 27 | 6 | 15 | 3,900 | 2,000 | 3 | 125 |
| 2.5 | 180 | X/7343-43 | A700X187M2R5ATE018 | 27 | 6 | 18 | 3,500 | 2,000 | 3 | 125 |
| 2.5 | 220 | X/7343-43 | A700X227M2R5ATE009 | 33 | 6 | 9 | 5,000 | 2,000 | 3 | 125 |
| 2.5 | 220 | X/7343-43 | A700X227M2R5ATE010 | 33 | 6 | 10 | 4,700 | 2,000 | 3 | 125 |
| 2.5 | 220 | X/7343-43 | A700X227M2R5ATE015 | 33 | 6 | 15 | 3,900 | 2,000 | 3 | 125 |
| 2.5 | 330 | X/7343-43 | A700X337M2R5ATE010 | 50 | 6 | 10 | 4,700 | 2,000 | 3 | 125 |
| (V) | µF | KEMET/EIA | (See below for part options) | µA at +25°C Maximum/ 5 Minutes | % at +25°C 120 Hz Maximum | mΩ at 25°C 100 kHz Maximum | mA at 100 kHz with/T = +20°C at -55°C to 125°C | (Hours) | Reflow Temp ≤ 260°C | °C |
| Rated Voltage | Rated Capacitance | Case Code/ Case Size | KEMET Part Number | DC Leakage | DF | ESR | Ripple Current | Endurance | MSL | Maximum Operating Temp. |

Higher voltage ratings and tighter tolerance product including ESR may be substituted within the same size at KEMET's option. Voltage substitutions will be marked with the higher voltage rating. Substitutions can include better than series.

Table 3 – Ratings & Part Number Reference cont.

| Rated Voltage | Rated Capacitance | Case Code/ Case Size | KEMET Part Number | DC Leakage | DF | ESR | Ripple Current (rms) | Endurance | MSL | Maximum Operating Temp. |
|---------------|-------------------|-------------------------|------------------------------|-----------------------------------|---------------------------|----------------------------|------------------------------------------------|-----------|---------------------|-------------------------|
| (V) | µF | KEMET/EIA | (See below for part options) | µA at +25°C Maximum/ 5 Minutes | % at +25°C 120 Hz Maximum | mΩ at 25°C 100 kHz Maximum | mA at 100 kHz with/T = +20°C at -55°C to 125°C | (Hours) | Reflow Temp ≤ 260°C | °C |
| 2.5 | 330 | X/7343-43 | A700X337M2R5ATE015 | 50 | 6 | 15 | 3,900 | 2,000 | 3 | 125 |
| 2.5 | 470 | X/7343-43 | A700X477M2R5ATE005 | 70 | 6 | 5 | 6,700 | 2,000 | 3 | 125 |
| 2.5 | 470 | X/7343-43 | A700X477M2R5ATE007 | 70 | 6 | 7 | 5,700 | 2,000 | 3 | 125 |
| 2.5 | 470 | X/7343-43 | A700X477M2R5ATE010 | 70 | 6 | 10 | 4,700 | 2,000 | 3 | 125 |
| 2.5 | 470 | X/7343-43 | A700X477M2R5ATE015 | 70 | 6 | 15 | 3,900 | 2,000 | 3 | 125 |
| 2.5 | 560 | X/7343-43 | A700X567M2R5ATE4R5 | 84 | 6 | 4.5 | 7,000 | 2,000 | 3 | 125 |
| 2.5 | 560 | X/7343-43 | A700X567M2R5ATE006 | 84 | 6 | 6 | 6,100 | 2,000 | 3 | 125 |
| 2.5 | 560 | X/7343-43 | A700X567M2R5ATE009 | 84 | 6 | 9 | 5,000 | 2,000 | 3 | 125 |
| 4 | 68 | V/7343-20 | A700V686M004ATE020 | 16 | 6 | 20 | 3,700 | 2,000 | 3 | 125 |
| 4 | 68 | V/7343-20 | A700V686M004ATE028 | 16 | 6 | 28 | 3,100 | 2,000 | 3 | 125 |
| 4 | 82 | V/7343-20 | A700V826M004ATE016 | 20 | 6 | 16 | 4,100 | 2,000 | 3 | 125 |
| 4 | 82 | V/7343-20 | A700V826M004ATE018 | 20 | 6 | 18 | 3,900 | 2,000 | 3 | 125 |
| 4 | 82 | V/7343-20 | A700V826M004ATE025 | 20 | 6 | 25 | 3,300 | 2,000 | 3 | 125 |
| 4 | 82 | V/7343-20 | A700V826M004ATE028 | 20 | 6 | 28 | 3,100 | 2,000 | 3 | 125 |
| 4 | 100 | D/7343-31 | A700D107M004ATE018 | 24 | 6 | 18 | 3,700 | 2,000 | 3 | 125 |
| 4 | 100 | D/7343-31 | A700D107M004ATE025 | 24 | 6 | 25 | 3,200 | 2,000 | 3 | 125 |
| 4 | 100 | D/7343-31 | A700D107M004ATE028 | 24 | 6 | 28 | 3,000 | 2,000 | 3 | 125 |
| 4 | 100 | V/7343-20 | A700V107M004ATE025 | 24 | 6 | 25 | 3,300 | 2,000 | 3 | 125 |
| 4 | 100 | V/7343-20 | A700V107M004ATE028 | 24 | 6 | 28 | 3,100 | 2,000 | 3 | 125 |
| 4 | 120 | D/7343-31 | A700D127M004ATE015 | 29 | 6 | 15 | 4,100 | 2,000 | 3 | 125 |
| 4 | 120 | D/7343-31 | A700D127M004ATE018 | 29 | 6 | 18 | 3,700 | 2,000 | 3 | 125 |
| 4 | 150 | D/7343-31 | A700D157M004ATE015 | 36 | 6 | 15 | 4,100 | 2,000 | 3 | 125 |
| 4 | 150 | D/7343-31 | A700D157M004ATE018 | 36 | 6 | 18 | 3,700 | 2,000 | 3 | 125 |
| 4 | 150 | V/7343-20 | A700V157M004ATE015 | 36 | 6 | 15 | 4,200 | 2,000 | 3 | 125 |
| 4 | 150 | V/7343-20 | A700V157M004ATE016 | 36 | 6 | 16 | 4,100 | 2,000 | 3 | 125 |
| 4 | 150 | V/7343-20 | A700V157M004ATE018 | 36 | 6 | 18 | 3,900 | 2,000 | 3 | 125 |
| 4 | 180 | D/7343-31 | A700D187M004ATE012 | 43 | 6 | 12 | 4,600 | 2,000 | 3 | 125 |
| 4 | 180 | D/7343-31 | A700D187M004ATE015 | 43 | 6 | 15 | 4,100 | 2,000 | 3 | 125 |
| 4 | 180 | D/7343-31 | A700D187M004ATE018 | 43 | 6 | 18 | 3,700 | 2,000 | 3 | 125 |
| 4 | 180 | X/7343-43 | A700X187M004ATE010 | 43 | 6 | 10 | 4,700 | 2,000 | 3 | 125 |
| 4 | 180 | X/7343-43 | A700X187M004ATE015 | 43 | 6 | 15 | 3,900 | 2,000 | 3 | 125 |
| 4 | 180 | X/7343-43 | A700X187M004ATE018 | 43 | 6 | 18 | 3,500 | 2,000 | 3 | 125 |
| 4 | 220 | D/7343-31 | A700D227M004ATE009 | 53 | 6 | 9 | 5,300 | 2,000 | 3 | 125 |
| 4 | 220 | D/7343-31 | A700D227M004ATE010 | 53 | 6 | 10 | 5,000 | 2,000 | 3 | 125 |
| 4 | 220 | D/7343-31 | A700D227M004ATE015 | 53 | 6 | 15 | 4,100 | 2,000 | 3 | 125 |
| 4 | 220 | X/7343-43 | A700X227M004ATE009 | 53 | 6 | 9 | 5,000 | 2,000 | 3 | 125 |
| 4 | 220 | X/7343-43 | A700X227M004ATE010 | 53 | 6 | 10 | 4,700 | 2,000 | 3 | 125 |
| 4 | 220 | X/7343-43 | A700X227M004ATE015 | 53 | 6 | 15 | 3,900 | 2,000 | 3 | 125 |
| 4 | 270 | X/7343-43 | A700X277M004ATE010 | 65 | 6 | 10 | 4,700 | 2,000 | 3 | 125 |
| 4 | 270 | X/7343-43 | A700X277M004ATE015 | 65 | 6 | 15 | 3,900 | 2,000 | 3 | 125 |
| 4 | 330 | X/7343-43 | A700X337M004ATE008 | 79 | 6 | 8 | 5,300 | 2,000 | 3 | 125 |
| 4 | 330 | X/7343-43 | A700X337M004ATE010 | 79 | 6 | 10 | 4,700 | 2,000 | 3 | 125 |
| 4 | 330 | X/7343-43 | A700X337M004ATE015 | 79 | 6 | 15 | 3,900 | 2,000 | 3 | 125 |
| 6.3 | 10 | V/7343-20 | A700V106M006ATE055 | 3 | 6 | 55 | 2,200 | 2,000 | 3 | 125 |
| 6.3 | 22 | V/7343-20 | A700V226M006ATE028 | 6 | 6 | 28 | 3,100 | 2,000 | 3 | 125 |
| 6.3 | 22 | V/7343-20 | A700V226M006ATE045 | 6 | 6 | 45 | 2,400 | 2,000 | 3 | 125 |
| 6.3 | 33 | V/7343-20 | A700V336M006ATE018 | 8 | 6 | 18 | 3,900 | 2,000 | 3 | 125 |
| 6.3 | 33 | V/7343-20 | A700V336M006ATE025 | 8 | 6 | 25 | 3,300 | 2,000 | 3 | 125 |
| 6.3 | 33 | V/7343-20 | A700V336M006ATE028 | 8 | 6 | 28 | 3,100 | 2,000 | 3 | 125 |
| 6.3 | 47 | V/7343-20 | A700V476M006ATE018 | 12 | 6 | 18 | 3,900 | 2,000 | 3 | 125 |
| (V) | µF | KEMET/EIA | (See below for part options) | µA at +25°C Maximum/ 5 Minutes | % at +25°C 120 Hz Maximum | mΩ at 25°C 100 kHz Maximum | mA at 100 kHz with/T = +20°C at -55°C to 125°C | (Hours) | Reflow Temp ≤ 260°C | °C |
| Rated Voltage | Rated Capacitance | Case Code/ Case Size | KEMET Part Number | DC Leakage | DF | ESR | Ripple Current | Endurance | MSL | Maximum Operating Temp. |

Higher voltage ratings and tighter tolerance product including ESR may be substituted within the same size at KEMET's option. Voltage substitutions will be marked with the higher voltage rating. Substitutions can include better than series.

Table 3 – Ratings & Part Number Reference cont.

| Rated Voltage | Rated Capacitance | Case Code/ Case Size | KEMET Part Number | DC Leakage | DF | ESR | Ripple Current (rms) | Endurance | MSL | Maximum Operating Temp. |
|---------------|-------------------|-------------------------|------------------------------|-----------------------------------|---------------------------|----------------------------|------------------------------------------------|-----------|---------------------|-------------------------|
| (V) | µF | KEMET/EIA | (See below for part options) | µA at +25°C Maximum/ 5 Minutes | % at +25°C 120 Hz Maximum | mΩ at 25°C 100 kHz Maximum | mA at 100 kHz with/T = +20°C at -55°C to 125°C | (Hours) | Reflow Temp ≤ 260°C | °C |
| 6.3 | 47 | V/7343-20 | A700V476M006ATE025 | 12 | 6 | 25 | 3,300 | 2,000 | 3 | 125 |
| 6.3 | 47 | V/7343-20 | A700V476M006ATE028 | 12 | 6 | 28 | 3,100 | 2,000 | 3 | 125 |
| 6.3 | 56 | V/7343-20 | A700V566M006ATE018 | 14 | 6 | 18 | 3,900 | 2,000 | 3 | 125 |
| 6.3 | 56 | V/7343-20 | A700V566M006ATE025 | 14 | 6 | 25 | 3,300 | 2,000 | 3 | 125 |
| 6.3 | 56 | V/7343-20 | A700V566M006ATE028 | 14 | 6 | 28 | 3,100 | 2,000 | 3 | 125 |
| 6.3 | 68 | V/7343-20 | A700V686M006ATE015 | 17 | 6 | 15 | 4,200 | 2,000 | 3 | 125 |
| 6.3 | 68 | V/7343-20 | A700V686M006ATE018 | 17 | 6 | 18 | 3,900 | 2,000 | 3 | 125 |
| 6.3 | 68 | V/7343-20 | A700V686M006ATE025 | 17 | 6 | 25 | 3,300 | 2,000 | 3 | 125 |
| 6.3 | 68 | V/7343-20 | A700V686M006ATE028 | 17 | 6 | 28 | 3,100 | 2,000 | 3 | 125 |
| 6.3 | 82 | V/7343-20 | A700V826M006ATE018 | 21 | 6 | 18 | 3,900 | 2,000 | 3 | 125 |
| 6.3 | 82 | V/7343-20 | A700V826M006ATE025 | 21 | 6 | 25 | 3,300 | 2,000 | 3 | 125 |
| 6.3 | 82 | V/7343-20 | A700V826M006ATE028 | 21 | 6 | 28 | 3,100 | 2,000 | 3 | 125 |
| 6.3 | 100 | V/7343-20 | A700V107M006ATE015 | 25 | 6 | 15 | 4,200 | 2,000 | 3 | 125 |
| 6.3 | 100 | V/7343-20 | A700V107M006ATE018 | 25 | 6 | 18 | 3,900 | 2,000 | 3 | 125 |
| 6.3 | 100 | V/7343-20 | A700V107M006ATE025 | 25 | 6 | 25 | 3,300 | 2,000 | 3 | 125 |
| 6.3 | 100 | D/7343-31 | A700D107M006ATE015 | 25 | 6 | 15 | 4,100 | 2,000 | 3 | 125 |
| 6.3 | 100 | D/7343-31 | A700D107M006ATE018 | 25 | 6 | 18 | 3,700 | 2,000 | 3 | 125 |
| 6.3 | 120 | D/7343-31 | A700D127M006ATE012 | 30 | 6 | 12 | 4,600 | 2,000 | 3 | 125 |
| 6.3 | 120 | D/7343-31 | A700D127M006ATE015 | 30 | 6 | 15 | 4,100 | 2,000 | 3 | 125 |
| 6.3 | 120 | D/7343-31 | A700D127M006ATE018 | 30 | 6 | 18 | 3,700 | 2,000 | 3 | 125 |
| 6.3 | 150 | D/7343-31 | A700D157M006ATE010 | 38 | 6 | 10 | 5,000 | 2,000 | 3 | 125 |
| 6.3 | 150 | D/7343-31 | A700D157M006ATE012 | 38 | 6 | 12 | 4,600 | 2,000 | 3 | 125 |
| 6.3 | 150 | D/7343-31 | A700D157M006ATE015 | 38 | 6 | 15 | 4,100 | 2,000 | 3 | 125 |
| 6.3 | 150 | X/7343-43 | A700X157M006ATE010 | 38 | 6 | 10 | 4,700 | 2,000 | 3 | 125 |
| 6.3 | 150 | X/7343-43 | A700X157M006ATE012 | 38 | 6 | 12 | 4,300 | 2,000 | 3 | 125 |
| 6.3 | 150 | X/7343-43 | A700X157M006ATE015 | 38 | 6 | 15 | 3,900 | 2,000 | 3 | 125 |
| 6.3 | 180 | D/7343-31 | A700D187M006ATE010 | 45 | 6 | 10 | 5,000 | 2,000 | 3 | 125 |
| 6.3 | 180 | D/7343-31 | A700D187M006ATE015 | 45 | 6 | 15 | 4,100 | 2,000 | 3 | 125 |
| 6.3 | 180 | X/7343-43 | A700X187M006ATE010 | 45 | 6 | 10 | 4,700 | 2,000 | 3 | 125 |
| 6.3 | 180 | X/7343-43 | A700X187M006ATE015 | 45 | 6 | 15 | 3,900 | 2,000 | 3 | 125 |
| 6.3 | 220 | X/7343-43 | A700X227M006ATE007 | 55 | 6 | 7 | 5,700 | 2,000 | 3 | 125 |
| 6.3 | 220 | X/7343-43 | A700X227M006ATE010 | 55 | 6 | 10 | 4,700 | 2,000 | 3 | 125 |
| 6.3 | 220 | X/7343-43 | A700X227M006ATE015 | 55 | 6 | 15 | 3,900 | 2,000 | 3 | 125 |
| 8 | 10 | V/7343-20 | A700V106M008ATE055 | 3 | 6 | 55 | 2,200 | 2,000 | 3 | 125 |
| 8 | 22 | V/7343-20 | A700V226M008ATE028 | 7 | 6 | 28 | 3,100 | 2,000 | 3 | 125 |
| 8 | 22 | V/7343-20 | A700V226M008ATE045 | 7 | 6 | 45 | 2,400 | 2,000 | 3 | 125 |
| 8 | 33 | V/7343-20 | A700V336M008ATE018 | 11 | 6 | 18 | 3,900 | 2,000 | 3 | 125 |
| 8 | 33 | V/7343-20 | A700V336M008ATE025 | 11 | 6 | 25 | 3,300 | 2,000 | 3 | 125 |
| 8 | 33 | V/7343-20 | A700V336M008ATE028 | 11 | 6 | 28 | 3,100 | 2,000 | 3 | 125 |
| 8 | 56 | D/7343-31 | A700D566M008ATE015 | 18 | 6 | 15 | 4,100 | 2,000 | 3 | 125 |
| 8 | 56 | D/7343-31 | A700D566M008ATE018 | 18 | 6 | 18 | 3,700 | 2,000 | 3 | 125 |
| 8 | 68 | D/7343-31 | A700D686M008ATE015 | 22 | 6 | 15 | 4,100 | 2,000 | 3 | 125 |
| 8 | 68 | D/7343-31 | A700D686M008ATE018 | 22 | 6 | 18 | 3,700 | 2,000 | 3 | 125 |
| 8 | 100 | X/7343-43 | A700X107M008ATE010 | 32 | 6 | 10 | 4,700 | 2,000 | 3 | 125 |
| 8 | 100 | X/7343-43 | A700X107M008ATE012 | 32 | 6 | 12 | 4,300 | 2,000 | 3 | 125 |
| 8 | 100 | X/7343-43 | A700X107M008ATE015 | 32 | 6 | 15 | 3,900 | 2,000 | 3 | 125 |
| 10 | 10 | V/7343-20 | A700V106M010ATE055 | 4 | 6 | 55 | 2,200 | 2,000 | 3 | 125 |
| 10 | 22 | V/7343-20 | A700V226M010ATE028 | 9 | 6 | 28 | 3,100 | 2,000 | 3 | 125 |
| 10 | 22 | V/7343-20 | A700V226M010ATE045 | 9 | 6 | 45 | 2,400 | 2,000 | 3 | 125 |
| 10 | 33 | V/7343-20 | A700V336M010ATE018 | 13 | 6 | 18 | 3,900 | 2,000 | 3 | 125 |
| (V) | µF | KEMET/EIA | (See below for part options) | µA at +25°C Maximum/ 5 Minutes | % at +25°C 120 Hz Maximum | mΩ at 25°C 100 kHz Maximum | mA at 100 kHz with/T = +20°C at -55°C to 125°C | (Hours) | Reflow Temp ≤ 260°C | °C |
| Rated Voltage | Rated Capacitance | Case Code/ Case Size | KEMET Part Number | DC Leakage | DF | ESR | Ripple Current | Endurance | MSL | Maximum Operating Temp. |

Higher voltage ratings and tighter tolerance product including ESR may be substituted within the same size at KEMET's option. Voltage substitutions will be marked with the higher voltage rating. Substitutions can include better than series.

Table 3 – Ratings & Part Number Reference cont.

| Rated Voltage | Rated Capacitance | Case Code/ Case Size | KEMET Part Number | DC Leakage | DF | ESR | Ripple Current (rms) | Endurance | MSL | Maximum Operating Temp. |
|----------------------------|-------------------|-------------------------|------------------------------|-----------------------------------|---------------------------|----------------------------|------------------------------------------------|-----------|---------------------|-------------------------|
| (V) | µF | KEMET/EIA | (See below for part options) | µA at +25°C Maximum/ 5 Minutes | % at +25°C 120 Hz Maximum | mΩ at 25°C 100 kHz Maximum | mA at 100 kHz with/T = +20°C at -55°C to 125°C | (Hours) | Reflow Temp ≤ 260°C | °C |
| 10 | 33 | V/7343-20 | A700V336M010ATE025 | 13 | 6 | 25 | 3,300 | 2,000 | 3 | 125 |
| 10 | 33 | V/7343-20 | A700V336M010ATE028 | 13 | 6 | 28 | 3,100 | 2,000 | 3 | 125 |
| 10 | 47 | V/7343-20 | A700V476M010ATE025 | 19 | 6 | 25 | 3,300 | 2,000 | 3 | 125 |
| 10 | 47 | V/7343-20 | A700V476M010ATE028 | 19 | 6 | 28 | 3,100 | 2,000 | 3 | 125 |
| 10 | 56 | D/7343-31 | A700D566M010ATE015 | 22 | 6 | 15 | 4,100 | 2,000 | 3 | 125 |
| 10 | 56 | D/7343-31 | A700D566M010ATE018 | 22 | 6 | 18 | 3,700 | 2,000 | 3 | 125 |
| 10 | 68 | D/7343-31 | A700D686M010ATE015 | 27 | 6 | 15 | 4,100 | 2,000 | 3 | 125 |
| 10 | 68 | D/7343-31 | A700D686M010ATE018 | 27 | 6 | 18 | 3,700 | 2,000 | 3 | 125 |
| 10 | 100 | X/7343-43 | A700X107M010ATE010 | 40 | 6 | 10 | 4,700 | 2,000 | 3 | 125 |
| 10 | 100 | X/7343-43 | A700X107M010ATE015 | 40 | 6 | 15 | 3,900 | 2,000 | 3 | 125 |
| 10 | 120 | X/7343-43 | A700X127M010ATE010 | 48 | 6 | 10 | 4,700 | 2,000 | 3 | 125 |
| 10 | 120 | X/7343-43 | A700X127M010ATE015 | 48 | 6 | 15 | 3,900 | 2,000 | 3 | 125 |
| 10 | 150 | X/7343-43 | A700X157M010ATE010 | 60 | 6 | 10 | 4,700 | 2,000 | 3 | 125 |
| 10 | 150 | X/7343-43 | A700X157M010ATE015 | 60 | 6 | 15 | 3,900 | 2,000 | 3 | 125 |
| 12.5 | 10 | V/7343-20 | A700V106M12RATE040 | 5 | 6 | 40 | 2,600 | 2,000 | 3 | 125 |
| 12.5 | 10 | V/7343-20 | A700V106M12RATE055 | 5 | 6 | 55 | 2,200 | 2,000 | 3 | 125 |
| 12.5 | 10 | V/7343-20 | A700V106M12RATE060 | 5 | 6 | 60 | 2,100 | 2,000 | 3 | 125 |
| 12.5 | 15 | V/7343-20 | A700V156M12RATE040 | 8 | 6 | 40 | 2,600 | 2,000 | 3 | 125 |
| 12.5 | 15 | V/7343-20 | A700V156M12RATE045 | 8 | 6 | 45 | 2,400 | 2,000 | 3 | 125 |
| 12.5 | 22 | V/7343-20 | A700V226M12RATE030 | 11 | 6 | 30 | 3,000 | 2,000 | 3 | 125 |
| 12.5 | 33 | V/7343-20 | A700V336M12RATE025 | 17 | 6 | 25 | 3,300 | 2,000 | 3 | 125 |
| 12.5 | 56 | D/7343-31 | A700D566M12RATE020 | 28 | 6 | 20 | 3,500 | 2,000 | 3 | 125 |
| 12.5 | 47 | D/7343-31 | A700D476M12RATE020 | 24 | 6 | 20 | 3,500 | 2,000 | 3 | 125 |
| 12.5 | 47 | D/7343-31 | A700D476M12RATE025 | 24 | 6 | 25 | 3,200 | 2,000 | 3 | 125 |
| 12.5 | 47 | D/7343-31 | A700D476M12RATE040 | 24 | 6 | 40 | 2,500 | 2,000 | 3 | 125 |
| 12.5 | 100 | X/7343-43 | A700X107M12RATE012 | 50 | 6 | 12 | 4,300 | 2,000 | 3 | 125 |
| 12.5 | 100 | X/7343-43 | A700X107M12RATE015 | 50 | 6 | 15 | 3,900 | 2,000 | 3 | 125 |
| 12.5 | 100 | X/7343-43 | A700X107M12RATE018 | 50 | 6 | 18 | 3,500 | 2,000 | 3 | 125 |
| 12.5 | 100 | X/7343-43 | A700X107M12RATE025 | 50 | 6 | 25 | 3,000 | 2,000 | 3 | 125 |
| 16 | 6.8 | V/7343-20 | A700V685M016ATE070 | 4 | 6 | 70 | 2,000 | 2,000 | 3 | 125 |
| 16 | 8.2 | V/7343-20 | A700V825M016ATE045 | 5 | 6 | 45 | 2,400 | 2,000 | 3 | 125 |
| 16 | 10 | V/7343-20 | A700V106M016ATE045 | 6 | 6 | 45 | 2,400 | 2,000 | 3 | 125 |
| 16 | 10 | V/7343-20 | A700V106M016ATE060 | 6 | 6 | 60 | 2,100 | 2,000 | 3 | 125 |
| 16 | 15 | V/7343-20 | A700V156M016ATE040 | 10 | 6 | 40 | 2,600 | 2,000 | 3 | 125 |
| 16 | 22 | V/7343-20 | A700V226M016ATE018 | 35 | 6 | 18 | 3,900 | 2,000 | 3 | 125 |
| 16 | 22 | V/7343-20 | A700V226M016ATE025 | 35 | 6 | 25 | 3,300 | 2,000 | 3 | 125 |
| 16 | 22 | V/7343-20 | A700V226M016ATE030 | 35 | 6 | 30 | 3,000 | 2,000 | 3 | 125 |
| 16 | 22 | D/7343-31 | A700D226M016ATE018 | 14 | 6 | 18 | 3,700 | 2,000 | 3 | 125 |
| 16 | 22 | D/7343-31 | A700D226M016ATE025 | 14 | 6 | 25 | 3,200 | 2,000 | 3 | 125 |
| 16 | 22 | D/7343-31 | A700D226M016ATE030 | 14 | 6 | 30 | 2,900 | 2,000 | 3 | 125 |
| 16 | 33 | V/7343-20 | A700V336M016ATE025 | 53 | 6 | 25 | 3,300 | 2,000 | 3 | 125 |
| 16 | 33 | V/7343-20 | A700V336M016ATE040 | 53 | 6 | 40 | 2,600 | 2,000 | 3 | 125 |
| 25 | 15 | V/7343-20 | A700V156M025ATE040 | 15 | 6 | 40 | 2,600 | 2,000 | 3 | 125 |
| 35 | 15 | D/7343-31 | A700D156M035ATE040 | 53 | 6 | 40 | 2,500 | 2,000 | 3 | 125 |
| 35 | 22 | X/7343-43 | A700X226M035ATE025 | 77 | 6 | 25 | 3,000 | 2,000 | 3 | 125 |
| 35 | 22 | X/7343-43 | A700X226M035ATE040 | 77 | 6 | 40 | 2,400 | 2,000 | 3 | 125 |
| 125°C / 3000 Hrs endurance | | | | | | | | | | |
| 2 | 470 | V/7343-21 | A700V477M002PTE009 | 56 | 6 | 9 | 5,500 | 3,000 | 3 | 125 |
| (V) | µF | KEMET/EIA | (See below for part options) | µA at +25°C Maximum/ 5 Minutes | % at +25°C 120 Hz Maximum | mΩ at 25°C 100 kHz Maximum | mA at 100 kHz with/T = +20°C at -55°C to 125°C | (Hours) | Reflow Temp ≤ 260°C | °C |
| Rated Voltage | Rated Capacitance | Case Code/ Case Size | KEMET Part Number | DC Leakage | DF | ESR | Ripple Current | Endurance | MSL | Maximum Operating Temp. |

Higher voltage ratings and tighter tolerance product including ESR may be substituted within the same size at KEMET's option. Voltage substitutions will be marked with the higher voltage rating. Substitutions can include better than series.

Derating Guidelines

| Voltage Rating | Maximum Recommended Steady State Voltage | Maximum Recommended Transient Voltage (1 ms – 1 μs) |
|----------------|------------------------------------------|-----------------------------------------------------|
| | -55°C to +105/125°C *1 | |
| 2 – 35 V | V_R | V_R |

V_R = Rated Voltage

Ripple Current/Ripple Voltage

Permissible AC ripple voltage and current are related to equivalent series resistance (ESR) and the power dissipation capabilities of the device. Permissible AC ripple voltage which may be applied is limited by two criteria

1. The positive peak AC voltage plus the DC bias voltage, if any, must not exceed the DC voltage rating of the capacitor.
2. The negative peak AC voltage, in combination with bias voltage, if any, must not exceed the allowable limits specified for reverse voltage. See the Reverse Voltage section for allowable limits

Power capability is determined based on a 20°C temperature rise. A higher temperature rise and therefore higher power capability is allowable as long as the ambient temperature plus temperature rise due to ripple current does not exceed the rated temperature of the part.

The maximum power dissipation by case size can be determined using the below table.

| KEMET Series and Case Code | EIA Case Code | Maximum Power Dissipation (Pmax) mWatts at 25°C with +20°C Rise |
|----------------------------|---------------|-----------------------------------------------------------------|
| A700Q | 7343-12 | 320 |
| A720V | 7343-21 | 410 |
| A700W | 7343-15 | 290 |
| A700V | 7343-20 | 270 |
| A700D | 7343-31 | 250 |
| A700X | 7343-43 | 225 |

Using the Pmax of the device, the maximum allowable rms ripple current or voltage may be determined.

$$I(max) = \sqrt{Pmax/R}$$

$$E(max) = Z \sqrt{Pmax/R}$$

I = rms ripple current (amperes)

E = rms ripple voltage (volts)

$Pmax$ = maximum power dissipation(watts)

R = ESR at specified frequency (ohms)

Z = Impedance at specified frequency (Ohms)

Refer to part number listings for permissible Arms limits.

Reverse Voltage

Polymer aluminum capacitors are polar devices and may be permanently damaged or destroyed if connected in the wrong polarity. These devices will withstand a certain degree of transient voltage reversal for short periods, as shown in the below table. Please note that these parts may not be operated continuously in reverse, even within these limits.

| Temperature | Permissible Transient Reverse Voltage |
|-------------|---------------------------------------|
| 25°C | 60% of Rated Voltage |
| 55°C | 50% of Rated Voltage |
| 85°C | 40% of Rated Voltage |
| 105°C/125°C | 30% of Rated Voltage |

Table 4 – Land Dimensions/Courtyard

| KEMET | Metric Size Code | Density Level A: Maximum (Most) Land Protrusion (mm) | | | | | Density Level B: Median (Nominal) Land Protrusion (mm) | | | | | Density Level C: Minimum (Least) Land Protrusion (mm) | | | | | |
|----------------|------------------|---------------------------------------------------------|------|------|------|-------|-----------------------------------------------------------|------|------|------|------|----------------------------------------------------------|------|------|------|------|------|
| | | Case | EIA | W | L | S | V1 | V2 | W | L | S | V1 | V2 | W | L | S | V1 |
| D | 7343-31 | | 2.55 | 2.77 | 3.67 | 10.22 | 5.60 | 2.43 | 2.37 | 3.87 | 9.12 | 5.10 | 2.33 | 1.99 | 4.03 | 8.26 | 4.84 |
| Q | 7343-12 | | 2.55 | 2.77 | 3.67 | 10.22 | 5.60 | 2.43 | 2.37 | 3.87 | 9.12 | 5.10 | 2.33 | 1.99 | 4.03 | 8.26 | 4.84 |
| V | 7343-20 | | 2.55 | 2.77 | 3.67 | 10.22 | 5.60 | 2.43 | 2.37 | 3.87 | 9.12 | 5.10 | 2.33 | 1.99 | 4.03 | 8.26 | 4.84 |
| W | 7343-15 | | 2.55 | 2.77 | 3.67 | 10.22 | 5.60 | 2.43 | 2.37 | 3.87 | 9.12 | 5.10 | 2.33 | 1.99 | 4.03 | 8.26 | 4.84 |
| X ¹ | 7343-43 | | 2.55 | 2.77 | 3.67 | 10.22 | 5.60 | 2.43 | 2.37 | 3.87 | 9.12 | 5.10 | 2.33 | 1.99 | 4.03 | 8.26 | 4.84 |

Density Level A: For low-density product applications. Recommended for wave solder applications and provides a wider process window for reflow solder processes.

Density Level B: For products with a moderate level of component density. Provides a robust solder attachment condition for reflow solder processes.

Density Level C: For high component density product applications. Before adapting the minimum land pattern variations the user should perform qualification testing based on the conditions outlined in IPC standard 7351 (IPC-7351).

¹ Height of these chips may create problems in wave soldering.

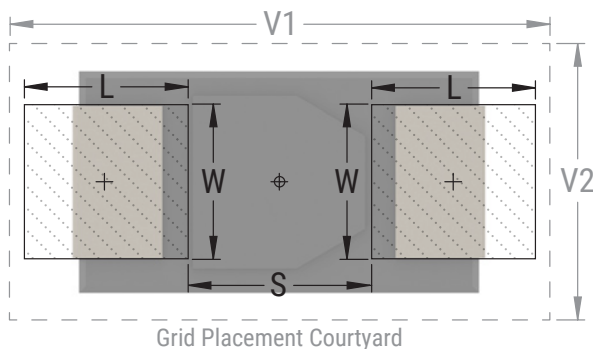

Soldering Process

KEMET's families of surface mount capacitors are compatible with wave (single or dual), convection, IR, or vapor phase reflow techniques. Preheating of these components is recommended to avoid extreme thermal stress. KEMET's recommended profile conditions for convection and IR reflow reflect the profile conditions of the IPC/J-STD-020D standard for moisture sensitivity testing. The devices can safely withstand a maximum of three reflow passes at these conditions.

Please note that although the X/7343-43 case size can withstand wave soldering, the tall profile (4.3 mm maximum) dictates care in wave process development.

Hand soldering should be performed with care due to the difficulty in process control. If performed, care should be taken to avoid contact of the soldering iron to the molded case. The iron should be used to heat the solder pad, applying solder between the pad and the termination, until reflow occurs. Once reflow occurs, the iron should be removed immediately. "Wiping" the edges of a chip and heating the top surface is not recommended.

| Profile Feature | SnPb Assembly | Pb-Free Assembly |
|-------------------------------------------------------|---------------------|---------------------|
| Preheat/Soak | | |
| Temperature Minimum (T_{smin}) | 100°C | 150°C |
| Temperature Maximum (T_{smax}) | 150°C | 200°C |
| Time (t_s) from T_{smin} to T_{smax} | 60 – 120 seconds | 60 – 120 seconds |
| Ramp-up Rate (T_L to T_p) | 3°C/seconds maximum | 3°C/seconds maximum |
| Liquidous Temperature (T_L) | 183°C | 217°C |
| Time Above Liquidous (t_L) | 60 – 150 seconds | 60 – 150 seconds |
| Peak Temperature (T_p) | 220°C* 235°C** | 250°C* 260°C** |
| Time within 5°C of Maximum Peak Temperature (t_p) | 20 seconds maximum | 30 seconds maximum |
| Ramp-down Rate (T_p to T_L) | 6°C/seconds maximum | 6°C/seconds maximum |
| Time 25°C to Peak Temperature | 6 minutes maximum | 8 minutes maximum |

Note: All temperatures refer to the center of the package, measured on the package body surface that is facing up during assembly reflow.

* For Case Size height > 2.5 mm

** For Case Size height ≤ 2.5 mm

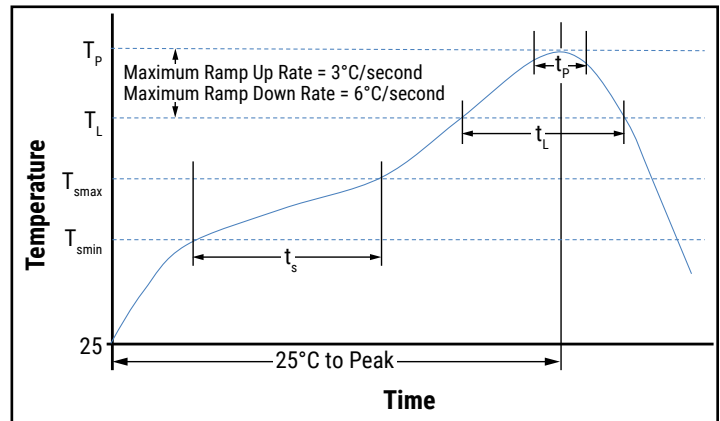

Storage

All AO-CAP Series are shipped in moisture barrier bags (MBBs) with desiccant and humidity indicator card (HIC). These parts are classified as MSL3 (Moisture Sensitivity Level 3) per IPC/JEDEC J-STD-020 and packaged per IPC/JEDEC J-STD-033. MSL3 specifies a floor time of 168H at 30°C maximum temperature and 60% relative humidity. Unused capacitors should be sealed in a MBB with fresh desiccant.

The calculated shelf life in a sealed bag would be 12 months from a bag seal date in a storage environment of < 40°C and humidity < 90% RH. It should be 24 months from a bag seal date in a storage environment of < 30°C and humidity < 70% RH.

If baking is required, refer to IPC/JEDEC J-STD-033 for bake procedure.

Construction

A700

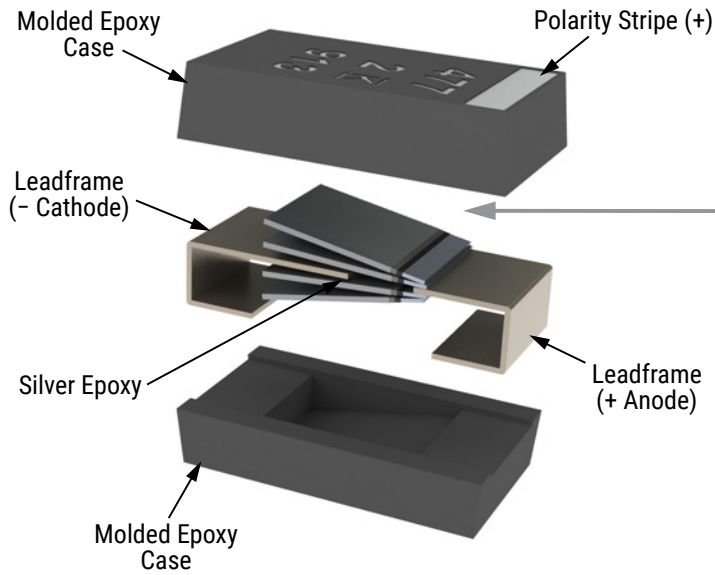

Detailed Element Layer View

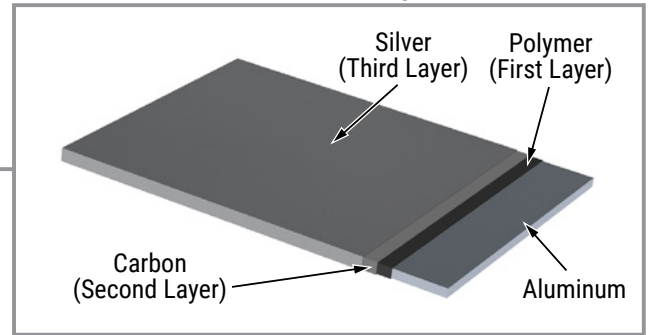

A720

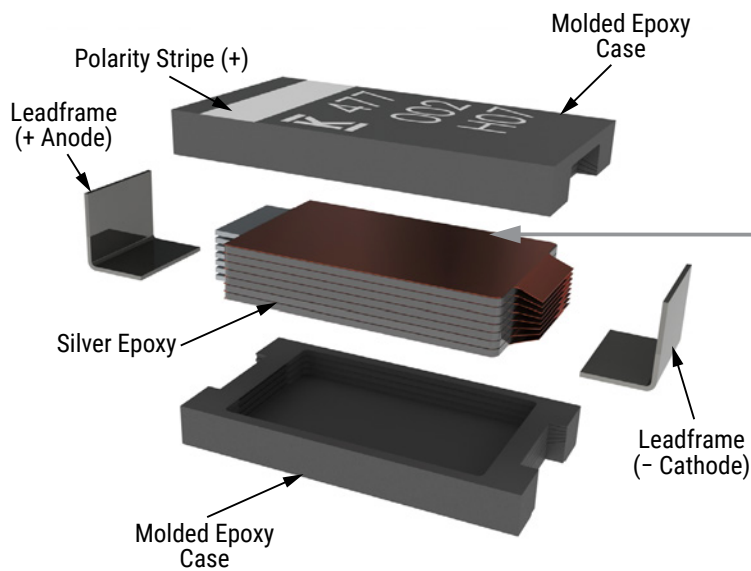

Detailed Element Layer View

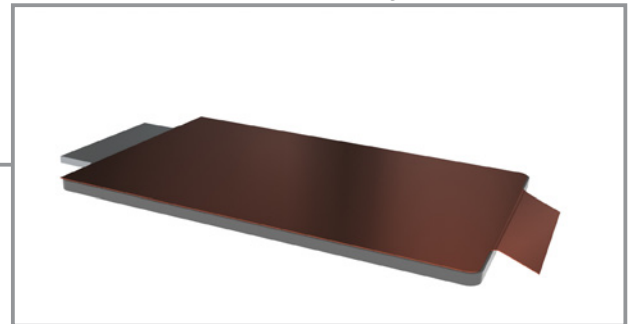

Capacitor Marking

A700

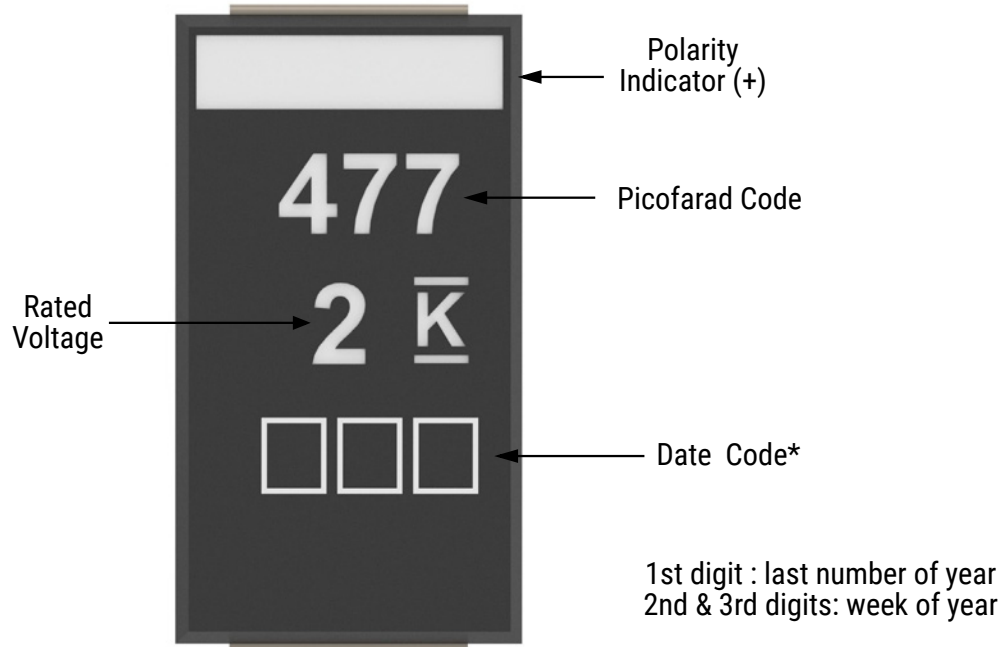

A720

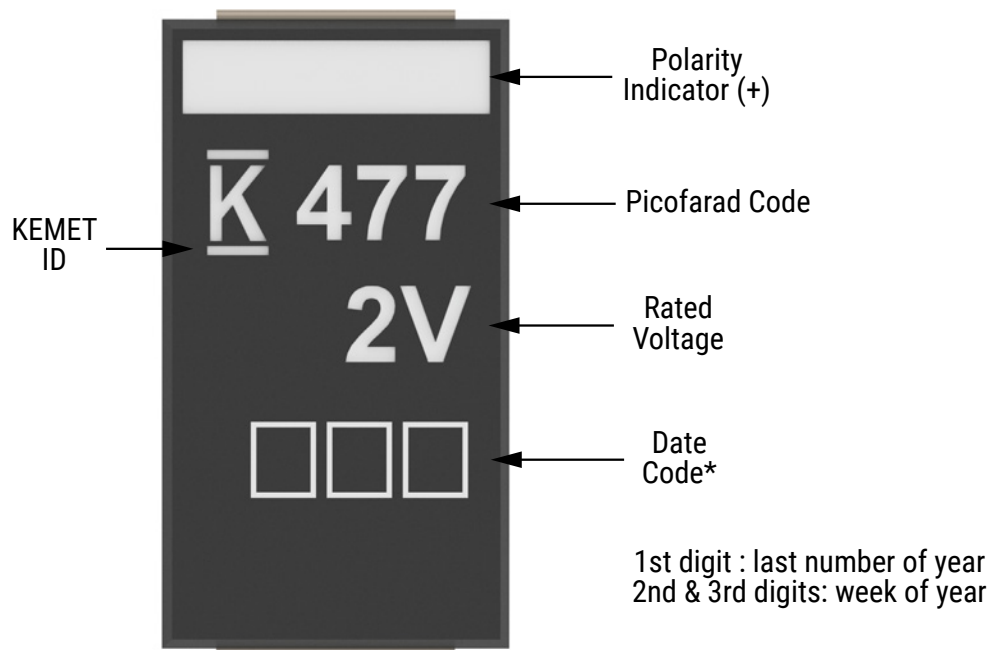

Tape & Reel Packaging Information

KEMET's molded chip capacitor families are packaged in 8 and 12 mm plastic tape on 7" and 13" reels in accordance with *EIA Standard 481: Embossed Carrier Taping of Surface Mount Components for Automatic Handling*. This packaging system is compatible with all tape-fed automatic pick-and-place systems.

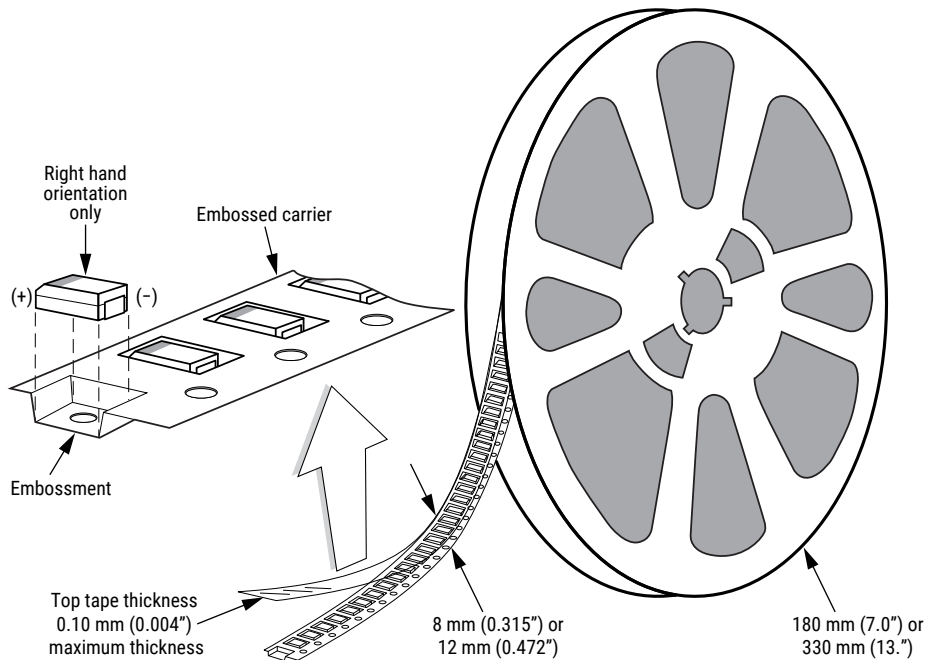

Table 3 – Packaging Quantity

| Case Code | | Tape Width (mm) | 7" Reel* | 13" Reel* |
|-----------|---------|-----------------|----------|-----------|
| KEMET | EIA | | | |
| P | 2012-10 | 8 | 3,000 | N/A |
| R | 2012-12 | 8 | 2,500 | 10,000 |
| I | 3216-10 | 8 | 3,000 | N/A |
| S | 3216-12 | 8 | 3,000 | N/A |
| A | 3216-18 | 8 | 2,000 | N/A |
| T | 3528-12 | 8 | 3,000 | 10,000 |
| M | 3528-15 | 8 | 2,500 | 8,000 |
| B | 3528-21 | 8 | 2,000 | 8,000 |
| U | 6032-15 | 12 | 1,000 | 5,000 |
| L | 6032-19 | 12 | 1,000 | 3,000 |
| C | 6032-28 | 12 | 500 | 3,000 |
| Q | 7343-12 | 12 | 1,000 | 3,000 |
| W | 7343-15 | 12 | 1,000 | 3,000 |
| Z | 7343-17 | 12 | 1,000 | 3,000 |
| V | 7343-19 | 12 | 1,000 | 3,000 |
| D | 7343-31 | 12 | 500 | 2,500 |
| Y | 7343-40 | 12 | 500 | 2,000 |
| X | 7343-43 | 12 | 500 | 2,000 |
| J | 7360-15 | 12 | 1,000 | 3,000 |
| H | 7360-20 | 12 | 1,000 | 3,000 |
| O | 7360-43 | 12 | 250 | 1,000 |

* No C-Spec required for 7" reel packaging. C-7280 required for 13" reel packaging.

Figure 1 – Embossed (Plastic) Carrier Tape Dimensions



Table 4 – Embossed (Plastic) Carrier Tape Dimensions

Metric will govern

| Constant Dimensions – Millimeters (Inches) | | | | | | | | | |
|--------------------------------------------|-------------------------------------------------------|-------------------------|------------------------------------------|-----------------------------------------|-----------------------------------------|-----------------------|-------------------------|------------------|------------------|
| Tape Size | D_0 | D_1 Minimum Note 1 | E_1 | P_0 | P_2 | R Reference Note 2 | S_1 Minimum Note 3 | T Maximum | T_1 Maximum |
| 8 mm | $1.5 \pm 0.10 / -0.0$ ($0.059 \pm 0.004 / -0.0$) | 1.0 (0.039) | 1.75 ± 0.10 (0.069 ± 0.004) | 4.0 ± 0.10 (0.157 ± 0.004) | 2.0 ± 0.05 (0.079 ± 0.002) | 25.0 (0.984) | 0.600 (0.024) | 0.600 (0.024) | 0.100 (0.004) |
| 12 mm | | 1.5 (0.059) | | | | | | | |

| Variable Dimensions – Millimeters (Inches) | | | | | | | | | |
|--------------------------------------------|---------------------------------------|-------------------------|------------------|-----------------------------------------|-----------------------------------------|----------------|-----------------|--------------------|--|
| Tape Size | Pitch | B_1 Maximum Note 4 | E_2 Minimum | F | P_1 | T_2 Maximum | W Maximum | A_0, B_0 & K_0 | |
| 8 mm | Single (4 mm) | 4.35 (0.171) | 6.25 (0.246) | 3.5 ± 0.05 (0.138 ± 0.002) | 4.0 ± 0.10 (0.157 ± 0.004) | 2.5 (0.098) | 8.3 (0.327) | Note 5 | |
| 12 mm | Single (4 mm) and Double (8 mm) | 8.2 (0.323) | 10.25 (0.404) | 5.5 ± 0.05 (0.217 ± 0.002) | 8.0 ± 0.10 (0.315 ± 0.004) | 4.6 (0.181) | 12.3 (0.484) | | |

1. The embossment hole location shall be measured from the sprocket hole controlling the location of the embossment. Dimensions of embossment location and hole location shall be applied independent of each other.
2. The tape, with or without components, shall pass around R without damage (see Figure 4).
3. If $S_1 < 1.0$ mm, there may not be enough area for cover tape to be properly applied (see EIA Standard 481-D, paragraph 4.3, section b).
4. B_1 dimension is a reference dimension for tape feeder clearance only.
5. The cavity defined by A_0, B_0 and K_0 shall surround the component with sufficient clearance that:
 - (a) the component does not protrude above the top surface of the carrier tape.
 - (b) the component can be removed from the cavity in a vertical direction without mechanical restriction, after the top cover tape has been removed.
 - (c) rotation of the component is limited to 20° maximum for 8 and 12 mm tapes (see Figure 2).
 - (d) lateral movement of the component is restricted to 0.5 mm maximum for 8 mm and 12 mm wide tape (see Figure 3).
 - (e) see Addendum in EIA Standard 481-D for standards relating to more precise taping requirements.

Packaging Information Performance Notes

- Cover tape break force:** 1.0 kg minimum.
- Cover tape peel strength:** The total peel strength of the cover tape from the carrier tape shall be:

| Tape Width | Peel Strength |
|------------|----------------------------------|
| 8 mm | 0.1 to 1.0 newton (10 to 100 gf) |
| 12 mm | 0.1 to 1.3 newton (10 to 130 gf) |

The direction of the pull shall be opposite the direction of the carrier tape travel. The pull angle of the carrier tape shall be 165° to 180° from the plane of the carrier tape. During peeling, the carrier and/or cover tape shall be pulled at a velocity of 300 ±10 mm/minute.

- Labeling:** Bar code labeling (standard or custom) shall be on the side of the reel opposite the sprocket holes. Refer to EIA Standards 556 and 624.

Figure 2 – Maximum Component Rotation



Figure 3 – Maximum Lateral Movement



Figure 4 – Bending Radius



Figure 5 – Reel Dimensions



Table 5 – Reel Dimensions

Metric will govern

| Constant Dimensions – Millimeters (Inches) | | | | |
|--------------------------------------------|------------------------------|---------------------------------------|----------------------------------------|---------------------------------------------------|
| Tape Size | A | B Minimum | C | D Minimum |
| 8 mm | 178 ±0.20 (7.008 ±0.008) | 1.5 (0.059) | 13.0 +0.5/-0.2 (0.521 +0.02/-0.008) | 20.2 (0.795) |
| 12 mm | 330 ±0.20 (13.000 ±0.008) | | | |
| Variable Dimensions – Millimeters (Inches) | | | | |
| Tape Size | N Minimum | W ₁ | W ₂ Maximum | W ₃ |
| 8 mm | 50 (1.969) | 8.4 +1.5/-0.0 (0.331 +0.059/-0.0) | 14.4 (0.567) | Shall accommodate tape width without interference |
| 12 mm | | 12.4 +2.0/-0.0 (0.488 +0.078/-0.0) | 18.4 (0.724) | |

Figure 6 – Tape Leader & Trailer Dimensions



Figure 7 – Maximum Camber



KEMET Electronics Corporation Sales Offices

For a complete list of our global sales offices, please visit www.kemet.com/sales.

Disclaimer

YAGEO Corporation and its affiliates do not recommend the use of commercial or automotive grade products for high reliability applications or manned space flight.

All product specifications, statements, information and data (collectively, the "Information") in this datasheet are subject to change. The customer is responsible for checking and verifying the extent to which the Information contained in this publication is applicable to an order at the time the order is placed. All Information given herein is believed to be accurate and reliable, but it is presented without guarantee, warranty, or responsibility of any kind, expressed or implied.

Statements of suitability for certain applications are based on KEMET Electronics Corporation's ("KEMET") knowledge of typical operating conditions for such applications, but are not intended to constitute – and KEMET specifically disclaims – any warranty concerning suitability for a specific customer application or use. The Information is intended for use only by customers who have the requisite experience and capability to determine the correct products for their application. Any technical advice inferred from this Information or otherwise provided by KEMET with reference to the use of KEMET's products is given gratis, and KEMET assumes no obligation or liability for the advice given or results obtained.

Although KEMET designs and manufactures its products to the most stringent quality and safety standards, given the current state of the art, isolated component failures may still occur. Accordingly, customer applications which require a high degree of reliability or safety should employ suitable designs or other safeguards (such as installation of protective circuitry or redundancies) in order to ensure that the failure of an electrical component does not result in a risk of personal injury or property damage.

Although all product-related warnings, cautions and notes must be observed, the customer should not assume that all safety measures are indicated or that other measures may not be required.

KEMET is a registered trademark of KEMET Electronics Corporation.

Looking for pricing, stock, or lifecycle information?

Click below to explore more details on WIN SOURCE:

 [View A700V477M002ATE4R5 on WIN SOURCE](#)

 [Kemet Information](#)

Optimize Your Supply Chain with WIN SOURCE Solutions

-  Global Sourcing Solution
-  Obsolete Management
-  Cost Control Management
-  Shortage Management
-  Alternative Solution
-  Excess Inventory Management