



**THE DATASHEET OF  
7V-25.000MAAE-T**



### Features

- Frequency range : 8MHz to 54MHz
- Glass sealing, ceramic SMD package
- External dimensions (mm)  
L : 3.2 x W : 2.5 x H : 0.8
- RoHS compliant  
Contains Pb, exempted by RoHS directive

### Applications

- PC, TV, Game, Camera
- Notebook, Hard disk
- Computer peripherals
- Home electronics
- Consumer products

### Electrical Characteristics

Item		7V	Conditions
Frequency Range	$F_0$	8MHz ~ 54MHz	
Frequency Tolerance	$F_{tol}$	±30ppm, ±20ppm, ±10ppm	at 25°C
Frequency Stability over Operating Temperature Range (refer to 25°C)	$F_{stab}$	±30 ppm	-20°C ~ +70°C
		±20 ppm	
		±10 ppm	
		±10 ppm	-30°C ~ +85°C
		±50 ppm	-40°C ~ +85°C
		±30 ppm	
		±20 ppm	
±60 ppm	-40°C ~ +125°C		
Operating Temperature Range	$T_{OTR}$	-20°C ~ +70°C	
		-30°C ~ +85°C	
		-40°C ~ +85°C	
		-40°C ~ +125°C	
Shunt Capacitance	$C_0$	3pF Max.	
Drive Level	$D_L$	1 ~ 50μW (10μW Typ.)	
Load Capacitance	$C_L$	6pF, 7pF, 8pF, 9pF, 10pF 12pF, 16pF, 18pF, 20pF	
Aging	$F_{aging}$	±3 ppm Max.	at 25°C ± 3°C, first year
Storage Temperature Range	$T_{STR}$	-55°C ~ +125°C	

### Motional Resistance (ESR)

Fundamental	
8 ~ 9 MHz	350Ω Max.
9 ~ 10 MHz	200Ω Max.
10 ~ 12 MHz	150Ω Max.
12 ~ 16 MHz	100Ω Max.
16 ~ 54 MHz	60Ω Max.

## Dimensions

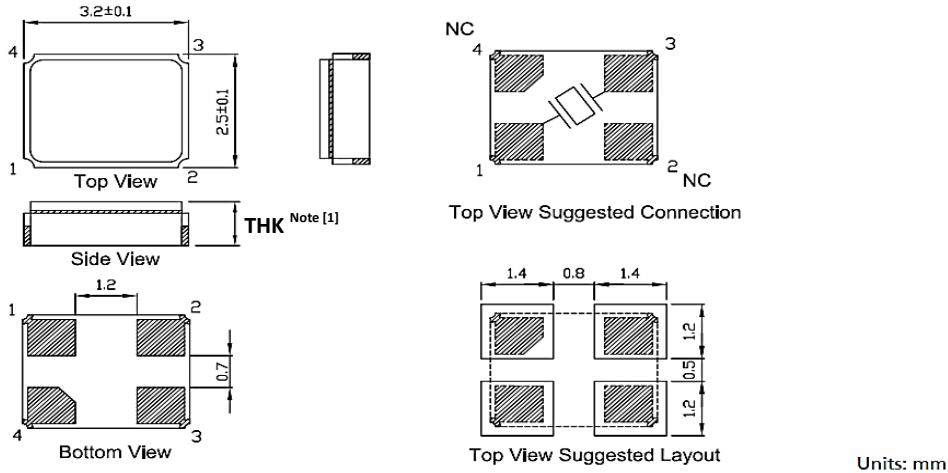

**Note:**

- [1] THK = 0.8 ± 0.1mm except F<sub>0</sub> = 8MHz.  
THK = 0.9 ± 0.1mm for F<sub>0</sub> = 8MHz.

## Ordering Information

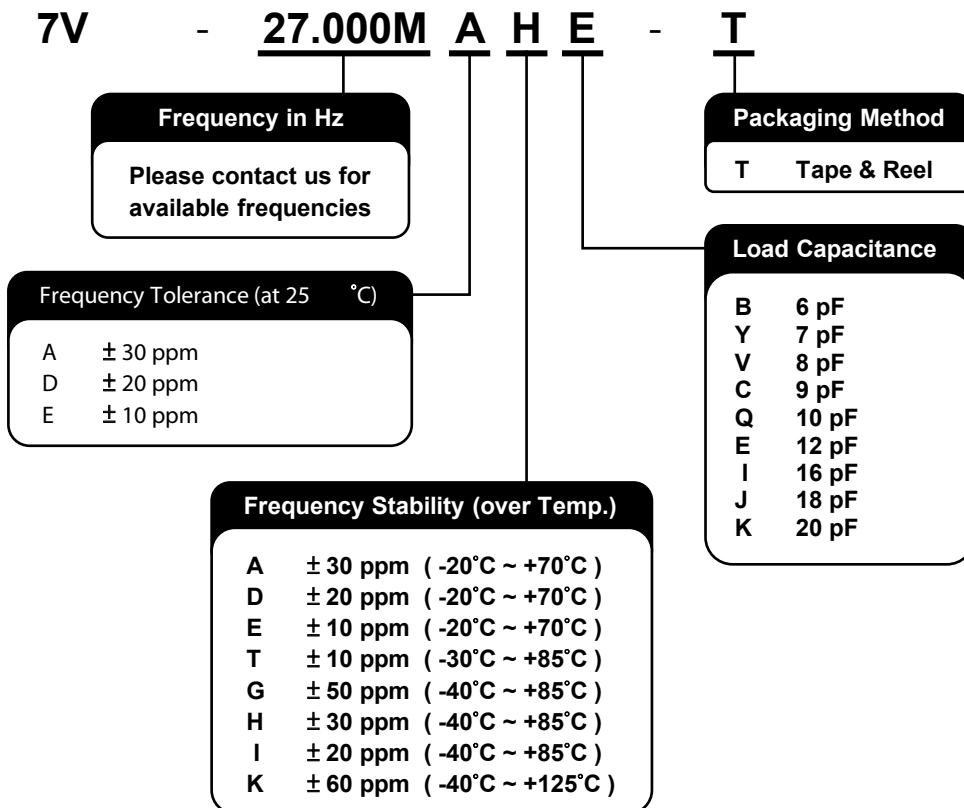

## Packing

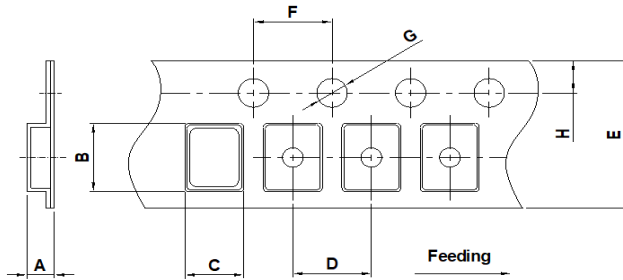

DIMENSIONS	A	B	C	D	E	F	G	H
	1.65±0.10	3.40±0.10	2.70±0.10	4.00±0.10	8.00±0.20	4.00±0.10	1.55±0.10	1.75±0.10

(Unit: mm)

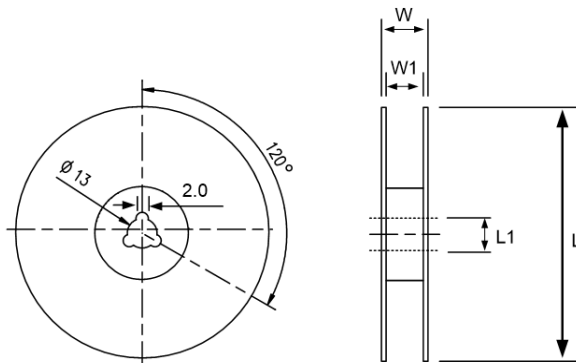

DIMENSIONS	L	L1	W	W1
	178±1.00	13±0.50	11.5±0.20	8±0.10

(Unit: mm)

## Reflow Profile

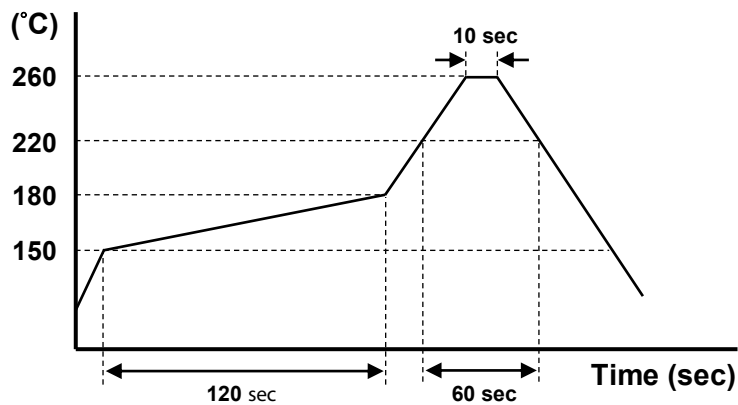

Solder melting point : 220°C ± 10°C, 60 sec. Min.

Peak temperature : 260°C ± 5°C, 10 sec. Min.



## Looking for pricing, stock, or lifecycle information?

Click below to explore more details on WIN SOURCE:

-  [View 7V-25.000MAAE-T on WIN SOURCE](#)
-  [TXC CORPORATION](#) Information

## Optimize Your Supply Chain with WIN SOURCE Solutions

-  Global Sourcing Solution
-  Obsolete Management
-  Cost Control Management
-  Shortage Management
-  Alternative Solution
-  Excess Inventory Management