



**THE DATASHEET OF
67-21-B3P-B3Q2R2M0C-2T8-AM**





Technical Data Sheet

Top View LEDs

67-21-B3P-B3Q2R2M0C-2T8-AM



Feature

- RoHS compliant.
- P-LCC-2 package.
- Wide viewing angle 120°.
- Colored diffused resin
- Brightness: 90 to 180mcd at 10mA
- Inner reflector and white package.
- Precondition: Bases on JEDEC J-STD 020D Level 3.
- Qualification according to AEC-Q101 rev C.
- Useable in severe lead free processes with automotive reflow profile (IR reflow or wave soldering)

Applications

- Automotive backlighting or indicator: Dashboard, switch, audio and video equipments...etc.
- Backlight: LCD, switches, symbol, mobile phone and illuminated advertising.
- Display for indoor and outdoor application.
- Ideal for coupling into light guides.
- Substitution of traditional light.
- Optical indicator.

Device Selection Guide

Chip	Emitted Color	Resin Color
Material		
InGaN/SiC	Pastel Emerald Green	Slightly Green Dotted

Technical Data Sheet**Top View LEDs****67-21-B3P-B3Q2R2M0C-2T8-AM****Absolute Maximum Ratings (Ta=25°C)**

Parameter	Symbol	Rating	Unit
Reverse Voltage	V _R	5	V
Forward Current	I _F	30	mA
Peak Forward Current (Duty 1/10 @1KHz)	I _{FP}	100	mA
Power Dissipation	P _d	120	mW
Junction Temperature	T _j	125	°C
Operating Temperature	T _{opr}	-40 ~ +100	°C
Storage Temperature	T _{stg}	-40 ~ +110	°C
Thermal resistance	R _{th J-A}	500	K/W
	R _{th J-S}	300	K/W
Soldering Temperature	T _{sol}	Reflow Soldering : 260 °C for 30 sec. Hand Soldering : 350 °C for 3 sec.	
ESD Classification acc. AEC Q101	ESD _{HBM}	2000	V
	ESD _{MM}	200	V

**Technical Data Sheet****Top View LEDs****67-21-B3P-B3Q2R2M0C-2T8-AM****Electro-Optical Characteristics (Ta=25°C)**

Parameter	Symbol	Min.	Typ.	Max.	Unit	Condition
Luminous Intensity	I_v	90	-----	180	mcd	$I_F=10\text{mA}$
Viewing Angle	$2\theta_{1/2}$	-----	120	-----	deg	$I_F=10\text{mA}$
Forward Voltage	V_F	2.75	3.0	3.95	V	$I_F=10\text{mA}$
Reverse Current	I_R	-----	0.01	10	μA	$V_R=5\text{V}$
Temperature coefficient of λ_p	TC_{λ_p}	-----	0.03	-----	nm/K	$I_F=10\text{mA}$
Temperature coefficient of λ_d	TC_{λ_d}	-----	0.04	-----	nm/K	$I_F=10\text{mA}$
Temperature coefficient of V_F	TC_V	-----	-2.6	-----	mV/K	$I_F=10\text{mA}$

Note:Tolerance of Luminous Intensity: $\pm 11\%$ Tolerance of Dominant Wavelength: $\pm 1\text{nm}$ Tolerance of Forward Voltage: $\pm 0.1\text{V}$

**Technical Data Sheet****Top View LEDs****67-21-B3P-B3Q2R2M0C-2T8-AM****Bin Range of Luminous Intensity**

Bin	Min.	Max.	Unit	Condition
Q2	90	112	mcd	I _F =10mA
R1	112	140		
R2	140	180		

Note:

Tolerance of Luminous Intensity : ±11%

Bin Range of Forward Voltage

Group	Bin	Min.	Max.	Unit	Condition
M	5	2.75	3.05	V	I _F =10mA
	6	3.05	3.35		
	7	3.35	3.65		
	8	3.65	3.95		

Note:

Tolerance of Forward Voltage: ±0.1V

**Technical Data Sheet****Top View LEDs****67-21-B3P-B3Q2R2M0C-2T8-AM****Bin Range of Chromatic Coordinates**

Bin Code	CIE_x	CIE_y	Bin Code	CIE_x	CIE_y	Condition
13S-1	0.135	0.308	13S-2	0.143	0.307	I _F =10mA
	0.141	0.350		0.149	0.349	
	0.149	0.349		0.158	0.348	
	0.143	0.307		0.152	0.306	
13S-3	0.152	0.306	13S-4	0.160	0.305	
	0.158	0.348		0.166	0.347	
	0.166	0.347		0.175	0.346	
	0.160	0.305		0.169	0.304	
13S-5	0.129	0.266	13S-6	0.137	0.265	
	0.135	0.308		0.143	0.307	
	0.143	0.307		0.152	0.306	
	0.137	0.265		0.146	0.264	
13S-7	0.146	0.264	13S-8	0.154	0.263	
	0.152	0.306		0.160	0.305	
	0.160	0.305		0.169	0.304	
	0.154	0.263		0.163	0.262	

Note:

1. Tolerance of Chromaticity Coordinates : ± 0.01 .

Technical Data Sheet

Top View LEDs

67-21-B3P-B3Q2R2M0C-2T8-AM

The C.I.E. 1931 chromaticity diagram

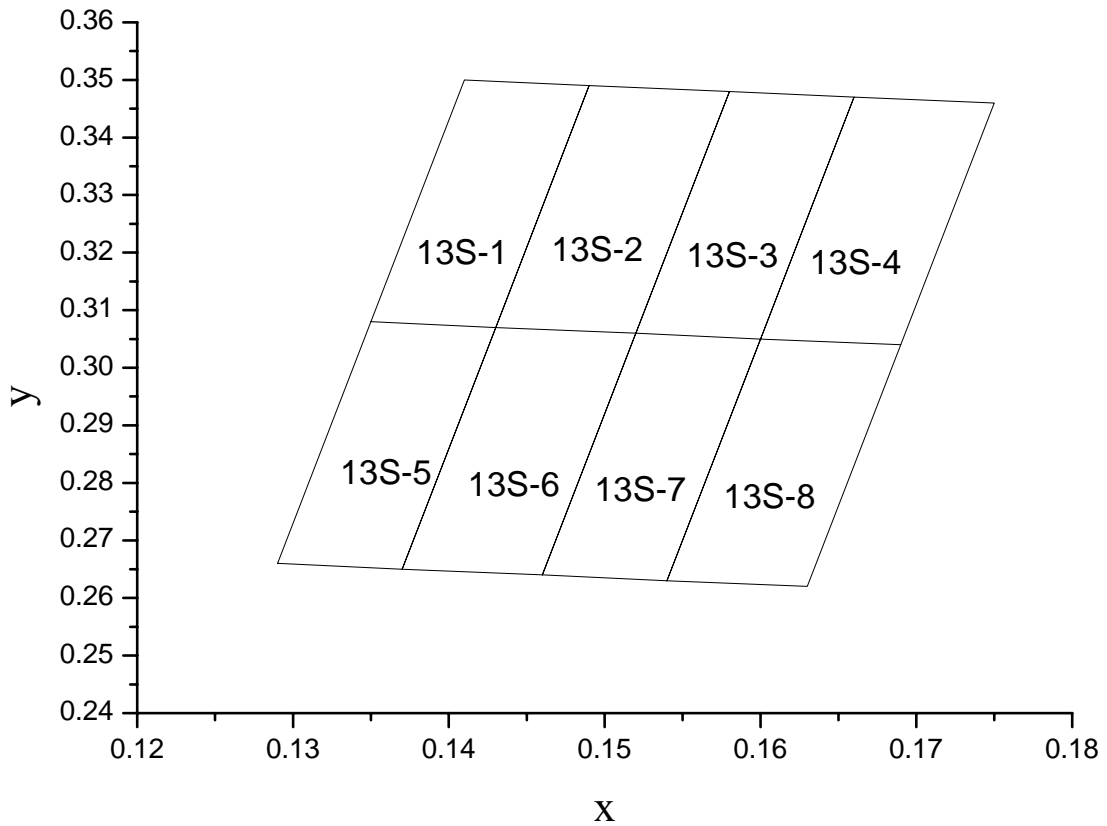

Technical Data Sheet

Top View LEDs

67-21-B3P-B3Q2R2M0C-2T8-AM

Typical Electro-Optical Characteristics Curves(Ta=25°C)

Typical Curve of Spectral Distribution:

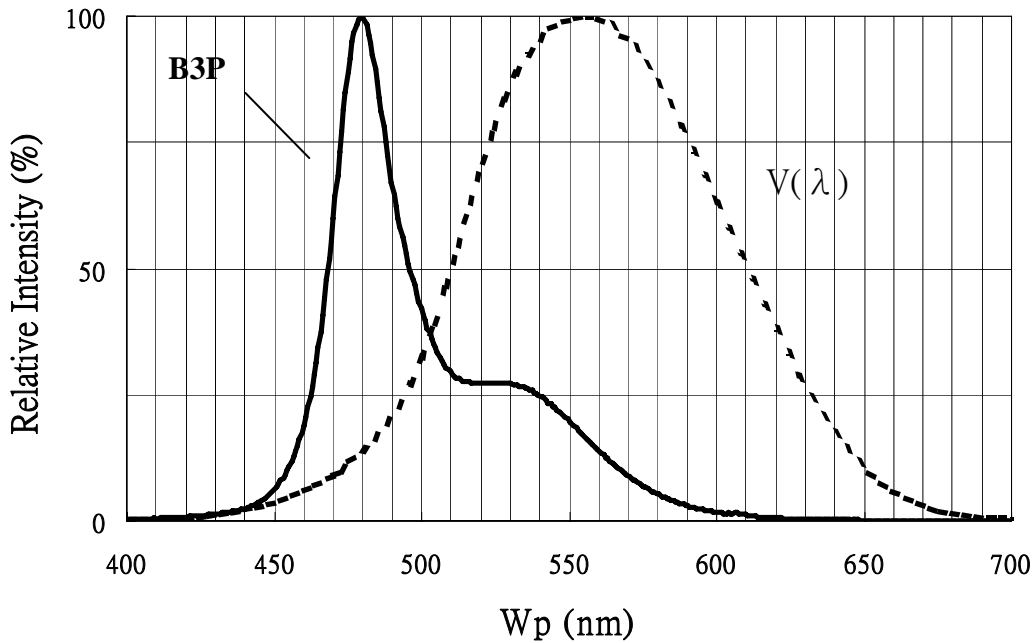

Note: V(λ)=Standard eye response curve ; I_F=10mA

Diagram characteristics of radiation

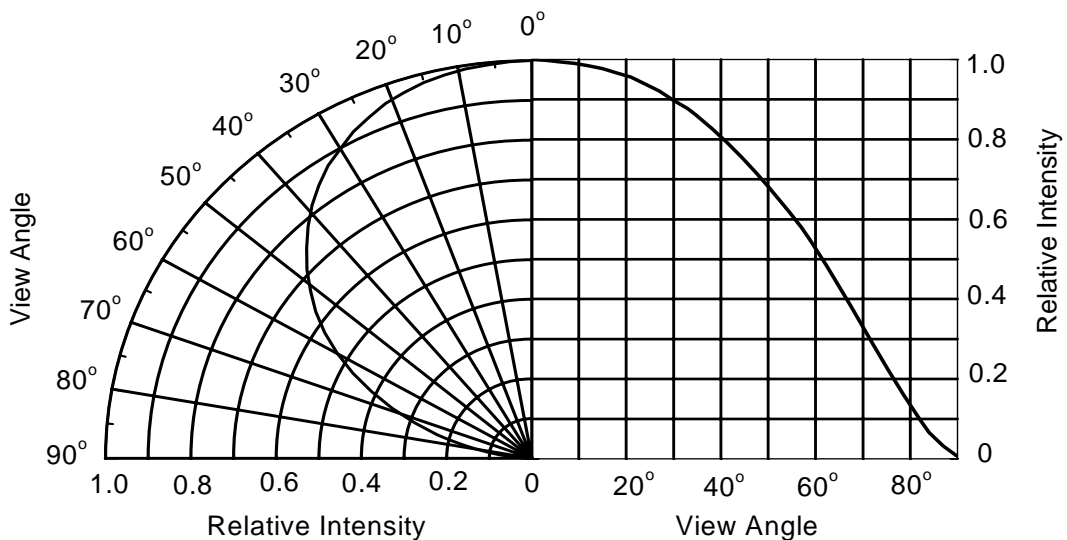

Technical Data Sheet

Top View LEDs

67-21-B3P-B3Q2R2M0C-2T8-AM

Forward Current vs. Forward Voltage (Ta=25°C)

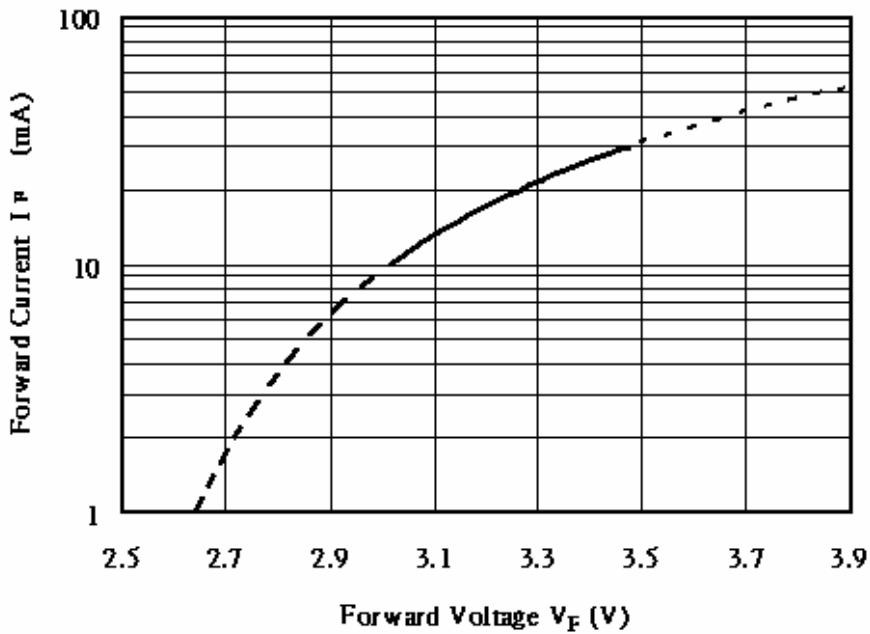

Relative Luminous Intensity vs. Forward Current (Ta=25°C)

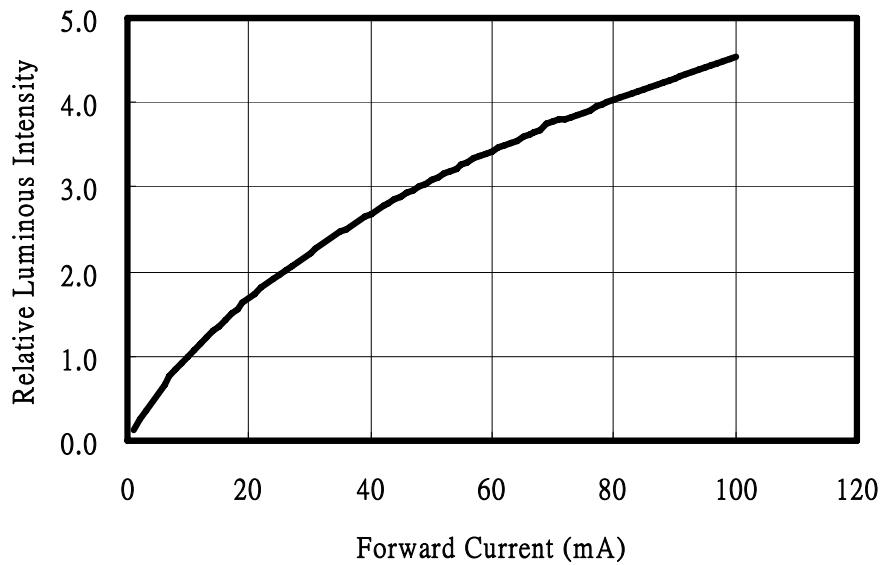

Technical Data Sheet

Top View LEDs

67-21-B3P-B3Q2R2M0C-2T8-AM

Chromaticity Coordinate Shift vs. Forward Current (Ta=25°C)

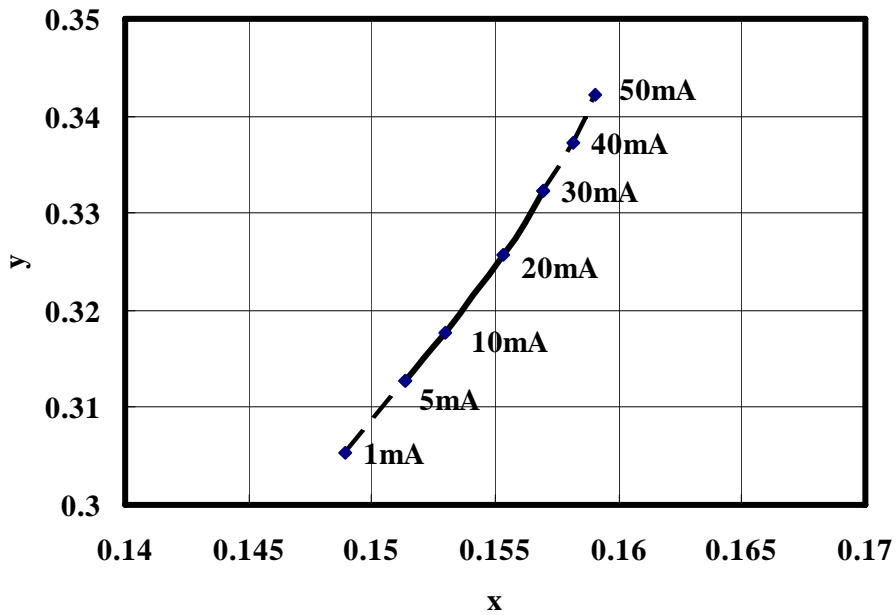

Forward Current vs. Ambient and Solder Temperature

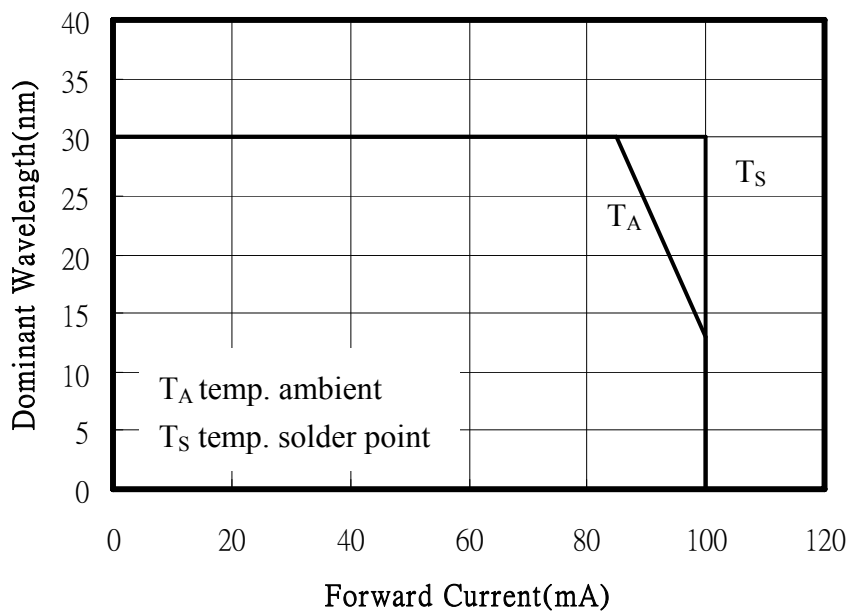

Technical Data Sheet

Top View LEDs

67-21-B3P-B3Q2R2M0C-2T8-AM

Relative Luminous Intensity vs. Junction Temperature

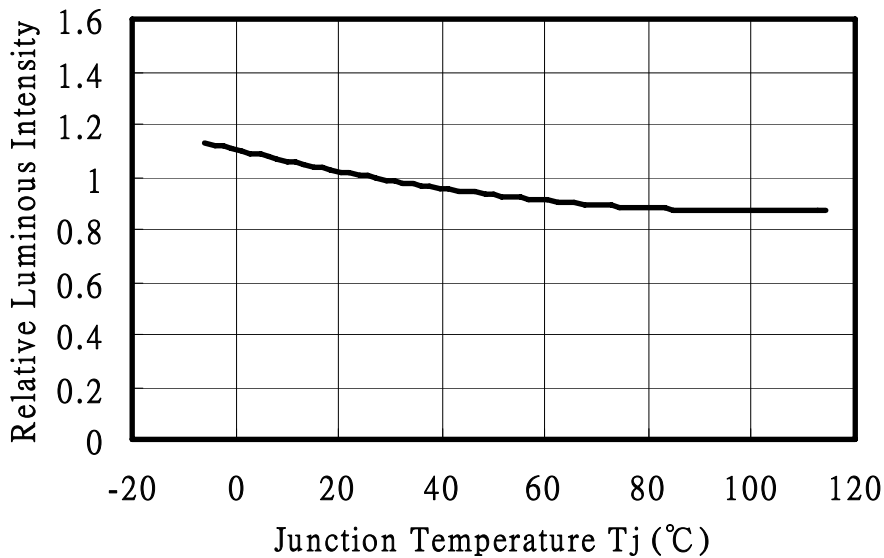

Note: $f(T_j) = I_v / I_v(25^\circ\text{C}) ; I_F=10\text{mA}$

Relative Forward Voltage vs. Junction Temperature

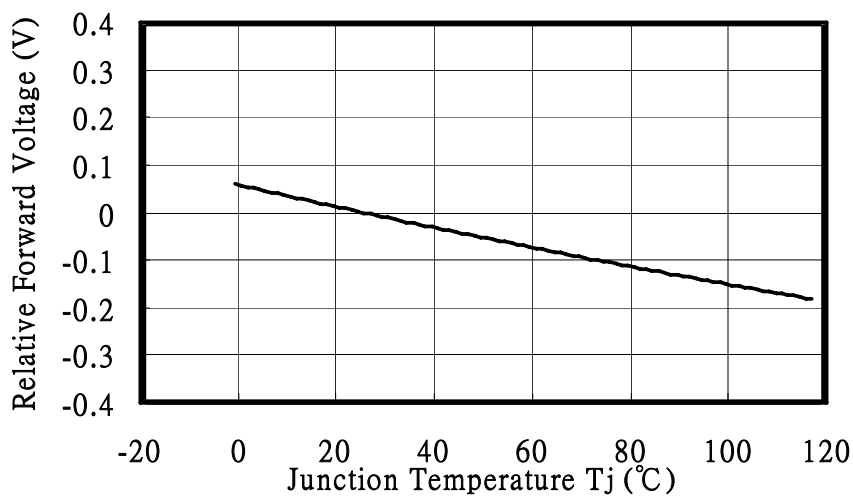

Note: $\Delta V_F = V_F - V_F(25^\circ\text{C}) = f(T_j) ; I_F=10\text{mA}$

Technical Data Sheet

Top View LEDs

67-21-B3P-B3Q2R2M0C-2T8-AM

Package Dimension

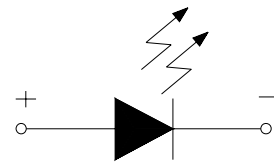
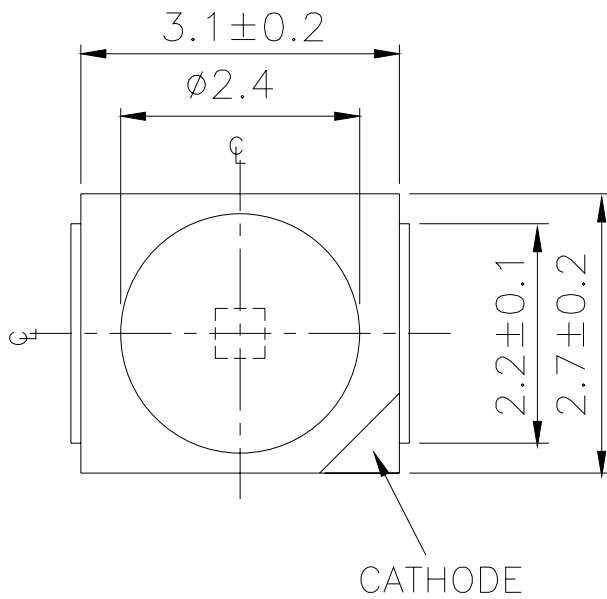

Polarity

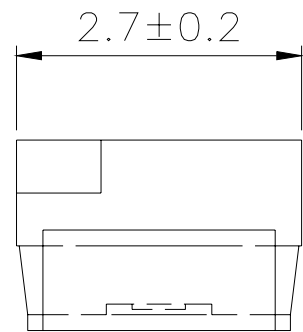
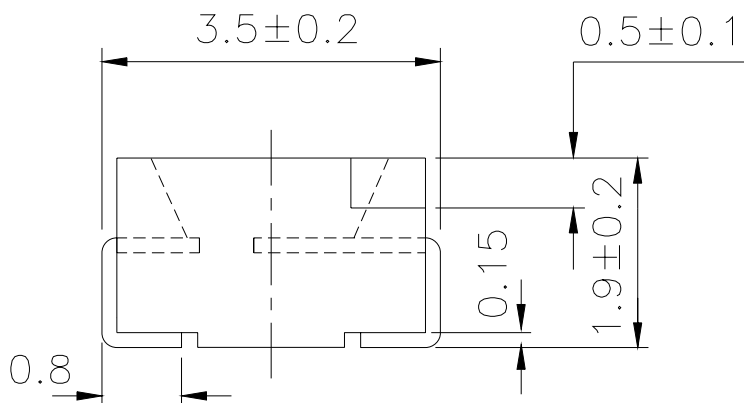

Note: Tolerances unless mentioned ±0.1mm. Unit = mm



Technical Data Sheet

Top View LEDs

67-21-B3P-B3Q2R2M0C-2T8-AM

Label Explanation

- CPN: Customer's Product Number
- P/N: Product Number
- QTY: Packing Quantity
- CAT: Luminous Intensity Rank
- HUE: Dom. Wavelength Rank
- REF: Forward Voltage Rank
- LOT No: Lot Number

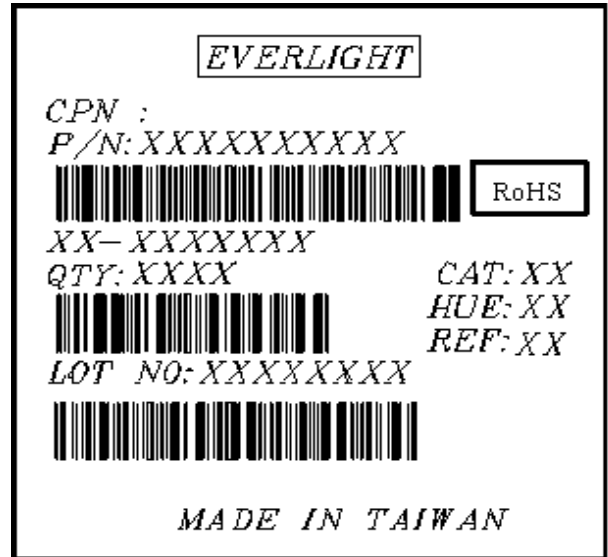

Reel Dimensions

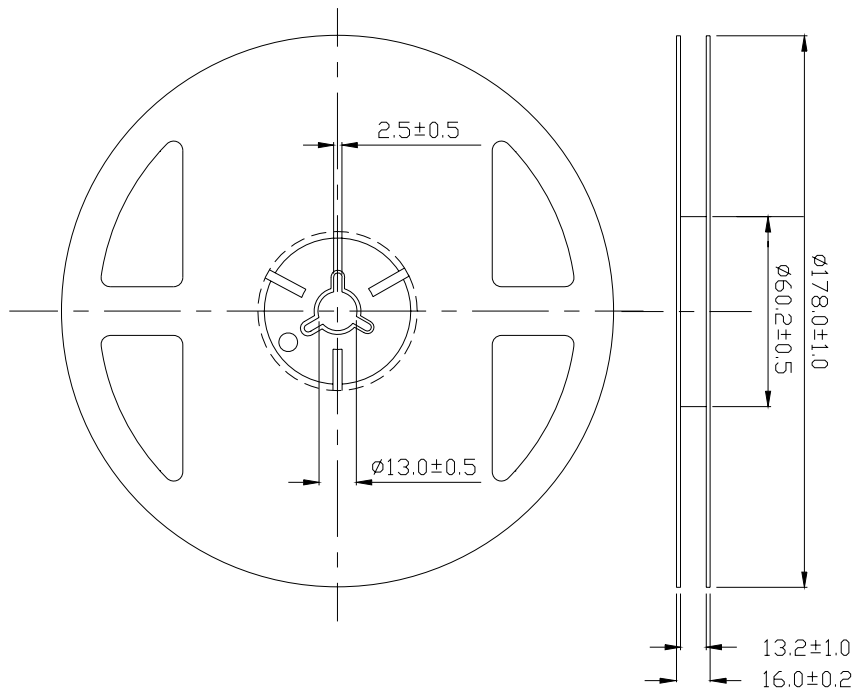

Note: Unit = mm

Technical Data Sheet

Top View LEDs

67-21-B3P-B3Q2R2M0C-2T8-AM

Carrier Tape Dimensions: Loaded Quantity 2000 pcs Per Reel

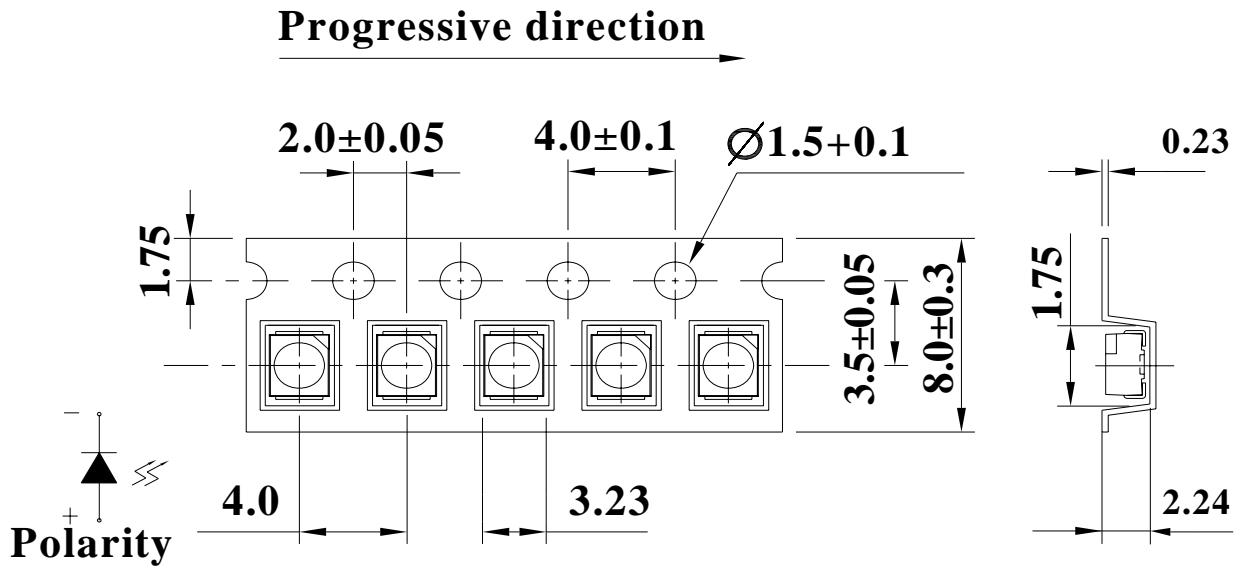

Note: Tolerances unless mentioned ±0.1mm. Unit = mm

Moisture Resistant Packaging Process and Materials

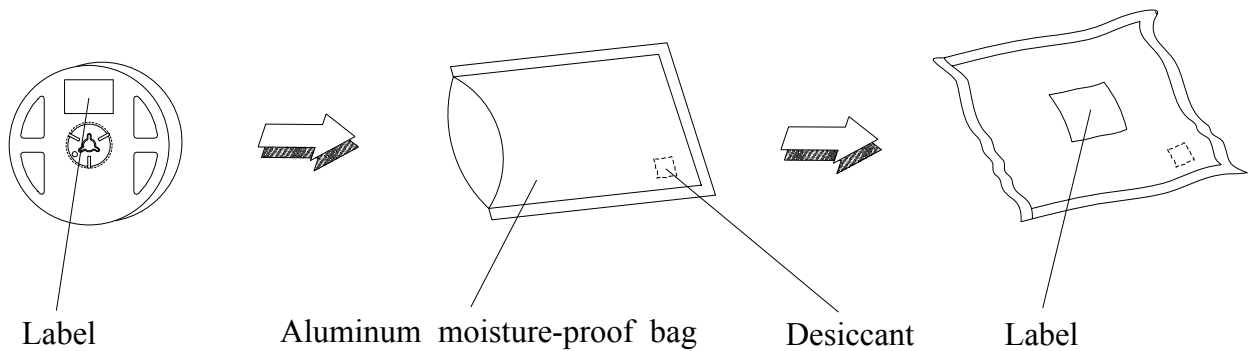

Technical Data Sheet

Top View LEDs

67-21-B3P-B3Q2R2M0C-2T8-AM

Precautions for Use

1. Soldering Condition

1.1 (A) Maximum Body Case Temperature Profile for evaluation of Reflow Profile

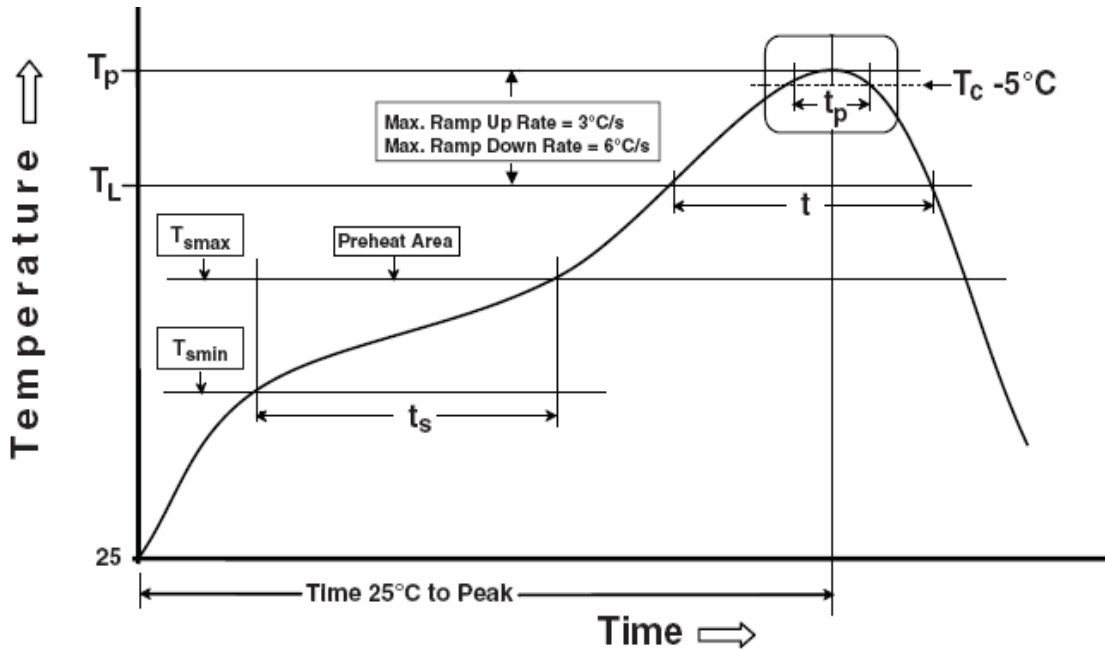

Note:

Preheat

Temperature min (T_{smin})

Temperature max (T_{smax})

Time (T_{smin} to T_{smax}) (t_s)

Average ramp-up rate (T_{smax} to T_p)

Other

Liquidus Temperature (T_L)

Time above Liquidus Temperature (t_L)

Peak Temperature (T_p)

Time within 5 °C of Actual Peak Temperature: $T_p - 5^\circ\text{C}$

Ramp- Down Rate from Peak Temperature

Time 25°C to peak temperature

Reflow times

All parameters are maximum body case temperature values and cannot be considered as a soldering profile. The body temperature was measured by soldering a thermal couple to the soldering point of LEDs.

Reference: IPC/JEDEC J-STD-020D

150 °C

200°C

60-120 seconds

3 °C/second max.

217 °C

60-150 sec

260°C

30 s

6°C /second max.

8 minutes max.

3 times

Technical Data Sheet

Top View LEDs

67-21-B3P-B3Q2R2M0C-2T8-AM

(B) Recommend soldering pad

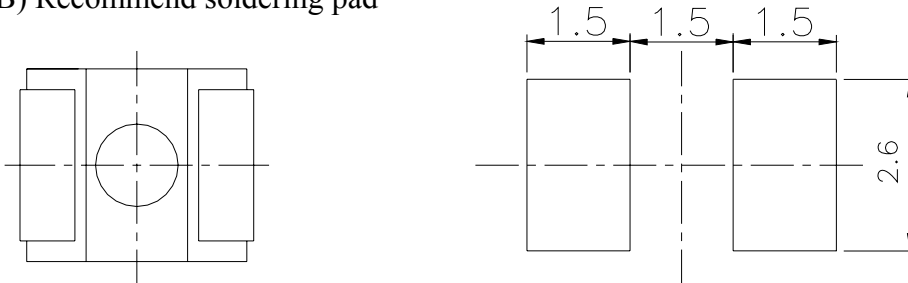

Note: Tolerances unless mentioned ± 0.1 mm. Unit = mm

2. Current limiting

A resistor should be used to limit current spikes that can be caused by voltage fluctuations. Otherwise damage could occur.

3. Storage

3.1 Moisture proof bag should only be opened immediately prior to usage.

3.2 Environment should be less than 30°C and 90% RH when moisture proof bag is opened.

3.3 After opening the package MSL Conditions stated on page 1 of this spec should not be exceeded.

3.4 If the moisture sensitivity card indicates higher than acceptable moisture, the component should be baked at min. 60°deg $\pm 5^{\circ}\text{deg}$ for 25 hours.

4. Iron Soldering

Hand soldering is not recommended for regular production. These guidelines are for rework only. Soldering iron tip should contact each terminal no more than 3 sec at 350°C , using soldering iron with nominal power less than 25W. Allow min. 2 sec. between soldering intervals.

5. Usage

Do not exceed the values given in this specification.

Application Restrictions

High reliability applications such as military/aerospace, automotive safety/security systems, and medical equipment may require different product. If you have any concerns, please contact Everlight before using this product in your application. This specification guarantees the quality and performance of the product as an individual component. Do not use this product beyond the specification described in this document.

Looking for pricing, stock, or lifecycle information?

Click below to explore more details on WIN SOURCE:

-  [View 67-21-B3P-B3Q2R2M0C-2T8-AM on WIN SOURCE](#)
-  [Everlight Electronics Co Ltd Information](#)

Optimize Your Supply Chain with WIN SOURCE Solutions

-  Global Sourcing Solution
-  Obsolete Management
-  Cost Control Management
-  Shortage Management
-  Alternative Solution
-  Excess Inventory Management