



**THE DATASHEET OF**  
**532BB000603DG**



# DUAL FREQUENCY CRYSTAL OSCILLATOR (XO) (10 MHz TO 1.4 GHz)

## Features

- Available with any-frequency output frequencies from 10 MHz to 945 MHz and select frequencies to 1.4 GHz
- Two selectable output frequencies
- 3<sup>rd</sup> generation DSPLL® with superior jitter performance
- 3x better frequency stability than SAW-based oscillators
- Internal fixed crystal frequency ensures high reliability and low aging
- Available CMOS, LVPECL, LVDS, and CML outputs
- 3.3, 2.5, and 1.8 V supply options
- Industry-standard 5 x 7 mm package and pinout
- Pb-free/RoHS-compliant

## Applications

- SONET/SDH
- Networking
- SD/HD video
- Test and measurement
- Clock and data recovery
- FPGA/ASIC clock generation

## Description

The Si532 dual frequency XO utilizes Skyworks Solutions advanced DSPLL® circuitry to provide a low jitter clock at high frequencies. The Si532 is available with any-frequency output frequency from 10 to 945 MHz and select frequencies to 1400 MHz. Unlike a traditional XO where a different crystal is required for each output frequency, the Si532 uses one fixed crystal frequency to provide a wide range of output frequencies. This IC based approach allows the crystal resonator to provide exceptional frequency stability and reliability. In addition, DSPLL clock synthesis provides superior supply noise rejection, simplifying the task of generating low jitter clocks in noisy environments typically found in communication systems. The Si532 IC based XO is factory configurable for a wide variety of user specifications including frequency, supply voltage, output format, and temperature stability. Specific configurations are factory programmed at time of shipment, thereby eliminating long lead times associated with custom oscillators.

## Functional Block Diagram

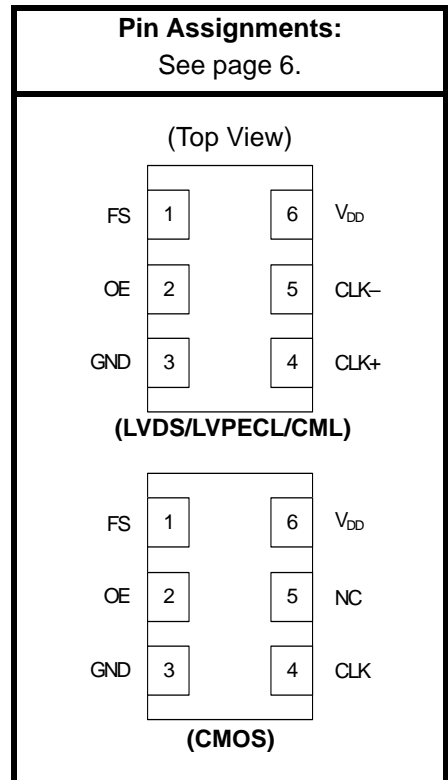
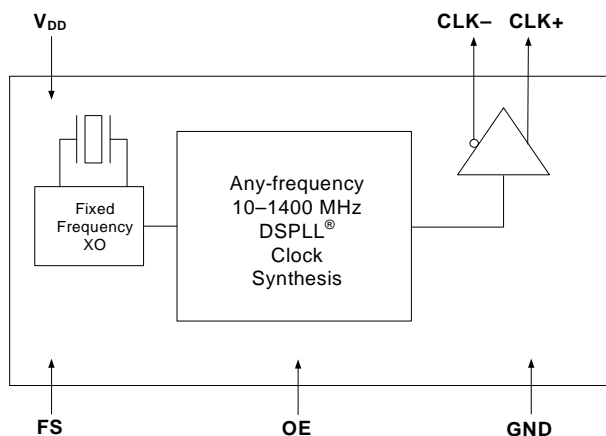

## 1. Electrical Specifications

**Table 1. Recommended Operating Conditions**

| Parameter  | Symbol          | Test Condition           | Min                    | Typ | Max  | Units |
|--|-----------------|--------------------------|------------------------|-----|------|-------|
| Supply Voltage <sup>1</sup>                                  | V <sub>DD</sub> | 3.3 V option             | 2.97                   | 3.3 | 3.63 | V     |
|  |                 | 2.5 V option             | 2.25                   | 2.5 | 2.75 | V     |
|  |                 | 1.8 V option             | 1.71                   | 1.8 | 1.89 | V     |
| Supply Current   | I <sub>DD</sub> | Output enabled<br>LVPECL | —                      | 111 | 121  | mA    |
|  |                 | CML                      | —                      | 99  | 108  |       |
|  |                 | LVDS                     | —                      | 90  | 98   |       |
|  |                 | CMOS                     | —                      | 81  | 88   |       |
|  |                 | Tristate mode            | —                      | 60  | 75   | mA    |
| Output Enable (OE)<br>and Frequency Select (FS) <sup>2</sup> |                 | V <sub>IH</sub>          | 0.75 x V <sub>DD</sub> | —   | —    | V     |
|  |                 | V <sub>IL</sub>          | —                      | —   | 0.5  | V     |
| Operating Temperature Range                                  | T <sub>A</sub>  |                          | −40                    | —   | 85   | °C    |

**Notes:**

- Selectable parameter specified by part number. See Section 3. "Ordering Information" on page 7 for further details.
- OE and FS pins include a 17 kΩ pullup resistor to V<sub>DD</sub>. Pulling OE to ground causes outputs to tristate.

**Table 2. CLK± Output Frequency Characteristics**

| Parameter                            | Symbol         | Test Condition                         | Min | Typ  | Max   | Units |
|--------------------------------------|----------------|--|-----|------|-------|-------|
| Nominal Frequency <sup>1,2</sup>     | f <sub>O</sub> | LVPECL/LVDS/CML                        | 10  | —    | 945   | MHz   |
|                                      |                | CMOS                                   | 10  | —    | 160   | MHz   |
| Initial Accuracy                     | f <sub>i</sub> | Measured at +25 °C at time of shipping | —   | ±1.5 | —     | ppm   |
| Temperature Stability <sup>1,3</sup> |                |  | −7  | —    | +7    | ppm   |
|                                      |                |  | −20 | —    | +20   |       |
|                                      |                |  | −50 | —    | +50   |       |
| Aging                                | f <sub>a</sub> | Frequency drift over first year        | —   | —    | ±3    | ppm   |
|                                      |                | Frequency drift over 20 year life      | —   | —    | ±10   | ppm   |
| Total Stability                      |                | Temp stability = ±7 ppm                | —   | —    | ±20   | ppm   |
|                                      |                | Temp stability = ±20 ppm               | —   | —    | ±31.5 | ppm   |
|                                      |                | Temp stability = ±50 ppm               | —   | —    | ±61.5 | ppm   |

**Notes:**

- See Section 3. "Ordering Information" on page 7 for further details.
- Specified at time of order by part number. Also available in frequencies from 970 to 1134 MHz and 1213 to 1417 MHz.
- Selectable parameter specified by part number.
- Time from powerup or tristate mode to f<sub>O</sub>.

Table 2. CLK± Output Frequency Characteristics (Continued)

| Parameter                     | Symbol           | Test Condition | Min | Typ | Max | Units |
|-------------------------------|------------------|----------------|-----|-----|-----|-------|
| Powerup Time <sup>4</sup>     | t <sub>OSC</sub> |                | —   | —   | 10  | ms    |
| Settling Time After FS Change | t <sub>FRQ</sub> |                | —   | —   | 10  | ms    |

**Notes:**

1. See Section 3. "Ordering Information" on page 7 for further details.
2. Specified at time of order by part number. Also available in frequencies from 970 to 1134 MHz and 1213 to 1417 MHz.
3. Selectable parameter specified by part number.
4. Time from powerup or tristate mode to f<sub>O</sub>.

Table 3. CLK± Output Levels and Symmetry

| Parameter                         | Symbol                          | Test Condition  | Min                    | Typ                    | Max                    | Units           |
|-----------------------------------|---------------------------------|---|------------------------|------------------------|------------------------|-----------------|
| LVPECL Output Option <sup>1</sup> | V <sub>O</sub>                  | mid-level   | V <sub>DD</sub> - 1.42 | —                      | V <sub>DD</sub> - 1.25 | V               |
|                                   | V <sub>OD</sub>                 | swing (diff)  | 1.1                    | —                      | 1.9                    | V <sub>PP</sub> |
|                                   | V <sub>SE</sub>                 | swing (single-ended)  | 0.55                   | —                      | 0.95                   | V <sub>PP</sub> |
| LVDS Output Option <sup>2</sup>   | V <sub>O</sub>                  | mid-level   | 1.125                  | 1.20                   | 1.275                  | V               |
|                                   | V <sub>OD</sub>                 | swing (diff)  | 0.5                    | 0.7                    | 0.9                    | V <sub>PP</sub> |
| CML Output Option <sup>2</sup>    | V <sub>O</sub>                  | 2.5/3.3 V option mid-level  | —                      | V <sub>DD</sub> - 1.30 | —                      | V               |
|                                   |                                 | 1.8 V option mid-level  | —                      | V <sub>DD</sub> - 0.36 | —                      | V               |
|                                   | V <sub>OD</sub>                 | 2.5/3.3 V option swing (diff)   | 1.10                   | 1.50                   | 1.90                   | V <sub>PP</sub> |
|                                   |                                 | 1.8 V option swing (diff)   | 0.35                   | 0.425                  | 0.50                   | V <sub>PP</sub> |
| CMOS Output Option <sup>3</sup>   | V <sub>OH</sub>                 | I <sub>OH</sub> = 32 mA   | 0.8 x V <sub>DD</sub>  | —                      | V <sub>DD</sub>        | V               |
|                                   | V <sub>OL</sub>                 | I <sub>OL</sub> = 32 mA   | —                      | —                      | 0.4                    |                 |
| Rise/Fall time (20/80%)           | t <sub>R</sub> , t <sub>F</sub> | LVPECL/LVDS/CML   | —                      | —                      | 350                    | ps              |
|                                   |                                 | CMOS with C <sub>L</sub> = 15 pF  | —                      | 1                      | —                      | ns              |
| Symmetry (duty cycle)             | SYM                             | LVPECL: V <sub>DD</sub> - 1.3 V (diff)<br>LVDS: 1.25 V (diff)<br>CMOS: V <sub>DD</sub> /2 | 45                     | —                      | 55                     | %               |

**Notes:**

1. 50 Ω to V<sub>DD</sub> - 2.0 V.
2. R<sub>term</sub> = 100 Ω (differential).
3. C<sub>L</sub> = 15 pF

**Table 4. CLK± Output Phase Jitter**

| Parameter  | Symbol         | Test Condition                         | Min | Typ  | Max  | Units |
|--|----------------|--|-----|------|------|-------|
| Phase Jitter (RMS) <sup>1</sup><br>for F <sub>OUT</sub> ≥ 500 MHz                  | ϕ <sub>J</sub> | 12 kHz to 20 MHz (OC-48)               | —   | 0.25 | 0.40 | ps    |
|  |                | 50 kHz to 80 MHz (OC-192)              | —   | 0.26 | 0.37 | ps    |
| Phase Jitter (RMS) <sup>1</sup><br>for F <sub>OUT</sub> of 125 to 500 MHz          | ϕ <sub>J</sub> | 12 kHz to 20 MHz (OC-48)               | —   | 0.36 | 0.50 | ps    |
|  |                | 50 kHz to 80 MHz (OC-192) <sup>2</sup> | —   | 0.34 | 0.42 | ps    |
| Phase Jitter (RMS) <sup>1</sup><br>for F <sub>OUT</sub> of 125 and 156.25 MHz Only | ϕ <sub>J</sub> | 12 kHz to 20 MHz (Brickwall)           | —   | 0.25 | 0.40 | ps    |
| Phase Jitter (RMS)<br>for F <sub>OUT</sub> of 10 to 160 MHz<br>CMOS Output Only    | ϕ <sub>J</sub> | 12 kHz to 20 MHz (OC-48) <sup>2</sup>  | —   | 0.62 | —    | ps    |
|  |                | 50 kHz to 20 MHz <sup>2</sup>          | —   | 0.61 | —    | ps    |

**Notes:**

1. Refer to AN256 for further information.
2. Max offset frequencies: 80 MHz for F<sub>OUT</sub> ≥ 250 MHz, 20 MHz for 50 MHz ≤ F<sub>OUT</sub> < 250 MHz, 2 MHz for 10 MHz ≤ F<sub>OUT</sub> < 50 MHz.

**Table 5. CLK± Output Period Jitter**

| Parameter      | Symbol           | Test Condition | Min | Typ | Max | Units |
|----------------|------------------|----------------|-----|-----|-----|-------|
| Period Jitter* | J <sub>PER</sub> | RMS            | —   | 2   | —   | ps    |
|                |                  | Peak-to-Peak   | —   | 14  | —   | ps    |

**\*Note:** Any output mode, including CMOS, LVPECL, LVDS, CML. N = 1000 cycles. Refer to AN279 for further information.

**Table 6. CLK± Output Phase Noise (Typical)**

| Offset Frequency (f) | 120.00 MHz<br>LVDS | 156.25 MHz<br>LVPECL | 622.08 MHz<br>LVPECL | Units  |
|----------------------|--------------------|----------------------|----------------------|--------|
| 100 Hz               | -112               | -105                 | -97                  | dBc/Hz |
| 1 kHz                | -122               | -122                 | -107                 |        |
| 10 kHz               | -132               | -128                 | -116                 |        |
| 100 kHz              | -137               | -135                 | -121                 |        |
| 1 MHz                | -144               | -144                 | -134                 |        |
| 10 MHz               | -150               | -147                 | -146                 |        |
| 100 MHz              | n/a                | n/a                  | -148                 |        |

**Table 7. Environmental Compliance**

The Si532 meets the following qualification test requirements.

| Parameter                  | Conditions/Test Method   |
|----------------------------|--------------------------|
| Mechanical Shock           | MIL-STD-883, Method 2002 |
| Mechanical Vibration       | MIL-STD-883, Method 2007 |
| Solderability              | MIL-STD-883, Method 2003 |
| Gross & Fine Leak          | MIL-STD-883, Method 1014 |
| Resistance to Solder Heat  | MIL-STD-883, Method 2036 |
| Moisture Sensitivity Level | J-STD_020, MSL1          |
| Contact Pads               | Gold over Nickel         |

**Table 8. Thermal Characteristics**

(Typical values  $T_A = 25\text{ }^\circ\text{C}$ ,  $V_{DD} = 3.3\text{ V}$ )

| Parameter                              | Symbol        | Test Condition | Min | Typ  | Max | Unit               |
|--|---------------|----------------|-----|------|-----|--------------------|
| Thermal Resistance Junction to Ambient | $\theta_{JA}$ | Still Air      | —   | 84.6 | —   | $^\circ\text{C/W}$ |
| Thermal Resistance Junction to Case    | $\theta_{JC}$ | Still Air      | —   | 38.8 | —   | $^\circ\text{C/W}$ |
| Ambient Temperature                    | $T_A$         |                | -40 | —    | 85  | $^\circ\text{C}$   |
| Junction Temperature                   | $T_J$         |                | —   | —    | 125 | $^\circ\text{C}$   |

**Table 9. Absolute Maximum Ratings<sup>1</sup>**

| Parameter  | Symbol     | Rating                 | Units            |
|--|------------|------------------------|------------------|
| Maximum Operating Temperature  | $T_{AMAX}$ | 85                     | $^\circ\text{C}$ |
| Supply Voltage, 1.8 V Option   | $V_{DD}$   | -0.5 to +1.9           | V                |
| Supply Voltage, 2.5/3.3 V Option                                       | $V_{DD}$   | -0.5 to +3.8           | V                |
| Input Voltage (any input pin)  | $V_I$      | -0.5 to $V_{DD} + 0.3$ | V                |
| Storage Temperature  | $T_S$      | -55 to +125            | $^\circ\text{C}$ |
| ESD Sensitivity (HBM, per JEDEC22-A114)                                | ESD        | 2500                   | V                |
| Soldering Temperature (Pb-free profile) <sup>2</sup>                   | $T_{PEAK}$ | 260                    | $^\circ\text{C}$ |
| Soldering Temperature Time @ $T_{PEAK}$ (Pb-free profile) <sup>2</sup> | $t_p$      | 20–40                  | seconds          |

**Notes:**

1. Stresses beyond those listed in Absolute Maximum Ratings may cause permanent damage to the device. Functional operation or specification compliance is not implied at these conditions.
2. The device is compliant with JEDEC J-STD-020C. Refer to Si5xx Packaging FAQ available for download at [www.skyworksinc.com/en/application-pages/timing-lookup-customize](http://www.skyworksinc.com/en/application-pages/timing-lookup-customize) for further information, including soldering profiles.

## 2. Pin Descriptions

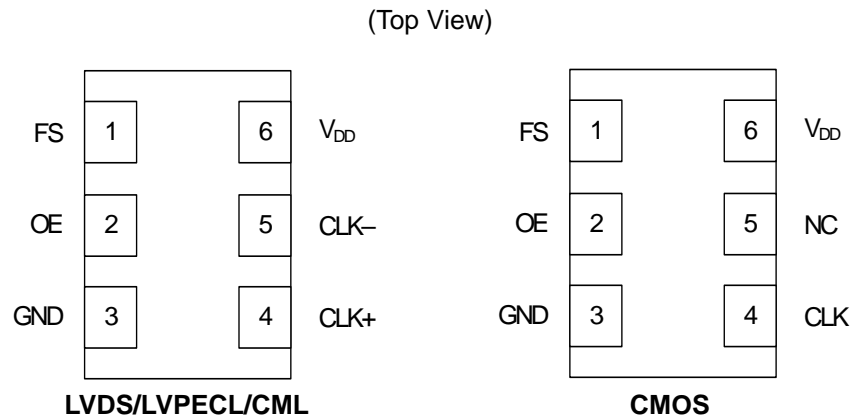

**Table 10. Pin Descriptions**

| Pin | Symbol          | LVDS/LVPECL/CML Function   | CMOS Function  |
|-----|-----------------|--|--|
| 1   | FS*             | Frequency Select<br>0 = First frequency selected<br>1 = Second frequency selected          | Frequency Select<br>0 = First frequency selected<br>1 = Second frequency selected          |
| 2   | OE*             | Output enable<br>0 = clock output disabled (outputs tristated)<br>1 = clock output enabled | Output enable<br>0 = clock output disabled (outputs tristated)<br>1 = clock output enabled |
| 3   | GND             | Electrical and Case Ground   | Electrical and Case Ground   |
| 4   | CLK+            | Oscillator Output  | Oscillator Output  |
| 5   | CLK-            | Complementary Output   | No connection  |
| 6   | V <sub>DD</sub> | Power Supply Voltage   | Power Supply Voltage   |

**\*Note:** FS and OE include a 17 kΩ pullup resistor to V<sub>DD</sub>. See Section 3. “Ordering Information” for details on frequency value ordering.

### 3. Ordering Information

The Si532 XO supports a variety of options including frequency, temperature stability, output format, and  $V_{DD}$ . Specific device configurations are programmed into the Si532 at time of shipment. Configurations can be specified using the Part Number Configuration chart below. Skyworks Solutions Laboratories provides a web browser-based part number configuration utility to simplify this process.

Refer to [www.skyworksinc.com/en/application-pages/timing-lookup-customize](http://www.skyworksinc.com/en/application-pages/timing-lookup-customize)

to access this tool and for further ordering instructions. The Si532 is supplied in an industry-standard, RoHS-compliant, 6-pad, 5 x 7 mm package.

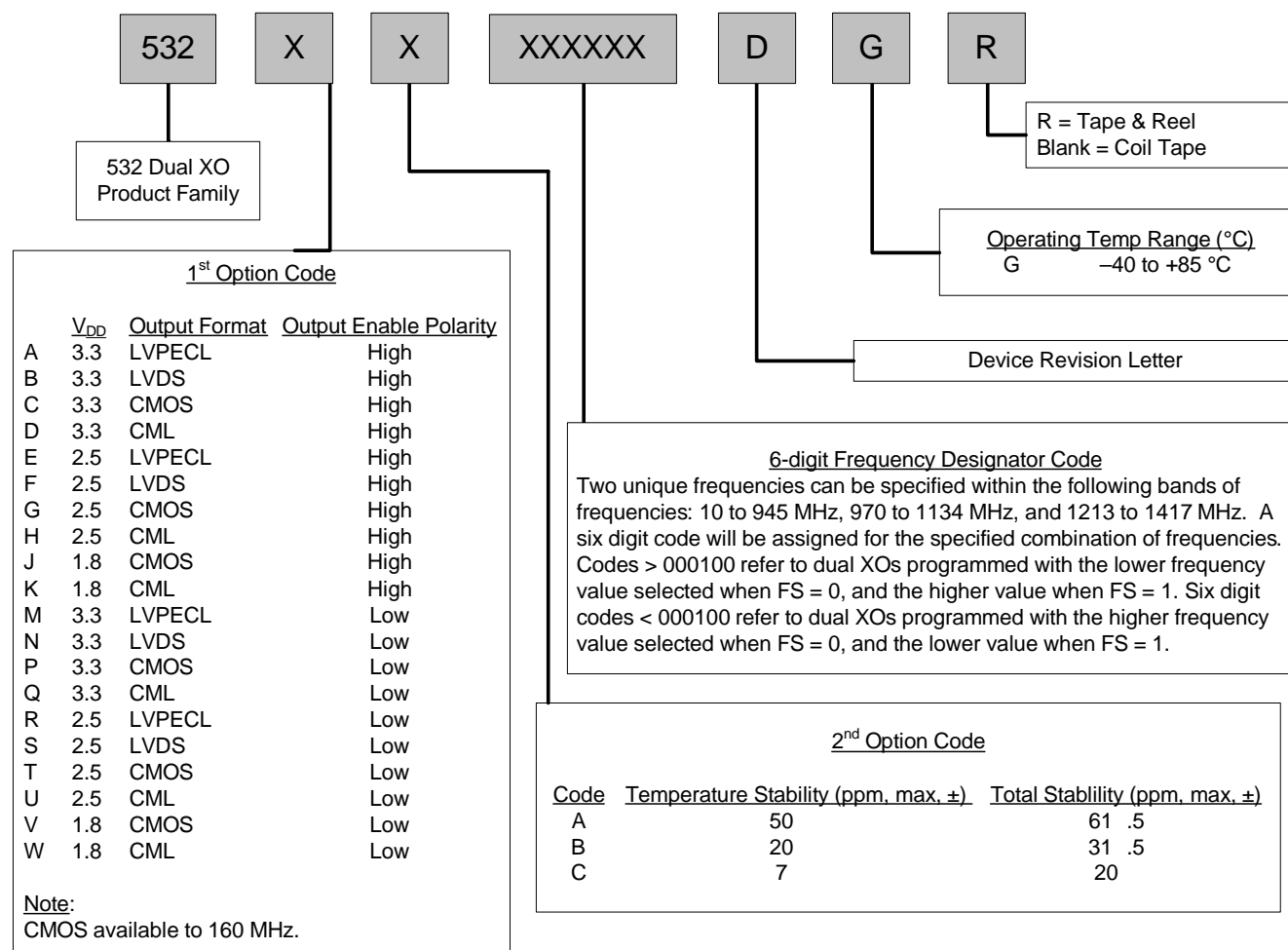

Example Part Number: 532AB000108DGR is a 5 x 7 mm Dual XO in a 6 pad package. Since the six digit code (000108) is > 000100, f0 is 644.53125 MHz (lower frequency) and f1 is 693.48299 (higher frequency), with a 3.3 V supply, LVPECL output, and Output Enable active high polarity. Temperature stability is specified as ±20 ppm. The part is specified for a -40 to +85 °C ambient temperature range operation and is shipped in tape and reel format.

**Figure 1. Part Number Convention**

## 4. Outline Diagram and Suggested Pad Layout

Figure 2 illustrates the package details for the Si532. Table 11 lists the values for the dimensions shown in the illustration.

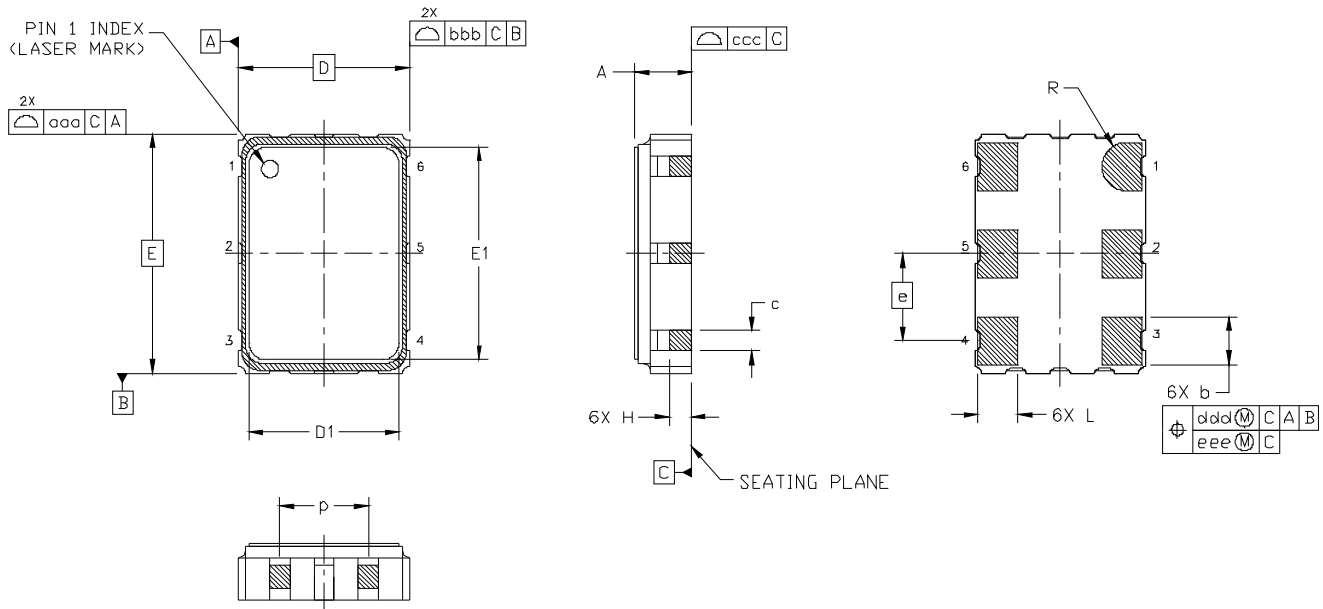

**Figure 2. Si532 Outline Diagram**

**Table 11. Package Diagram Dimensions (mm)**

| Dimension | Min      | Nom  | Max  |
|-----------|----------|------|------|
| A         | 1.50     | 1.65 | 1.80 |
| b         | 1.30     | 1.40 | 1.50 |
| c         | 0.50     | 0.60 | 0.70 |
| D         | 5.00 BSC |      |      |
| D1        | 4.30     | 4.40 | 4.50 |
| e         | 2.54 BSC |      |      |
| E         | 7.00 BSC |      |      |
| E1        | 6.10     | 6.20 | 6.30 |
| H         | 0.55     | 0.65 | 0.75 |
| L         | 1.17     | 1.27 | 1.37 |
| p         | 1.80     | —    | 2.60 |
| R         | 0.70 REF |      |      |
| aaa       | 0.15     |      |      |
| bbb       | 0.15     |      |      |
| ccc       | 0.10     |      |      |
| ddd       | 0.10     |      |      |
| eee       | 0.05     |      |      |

## 5. Si532 Mark Specification

Figure 3 illustrates the mark specification for the Si532. Table 12 lists the line information.

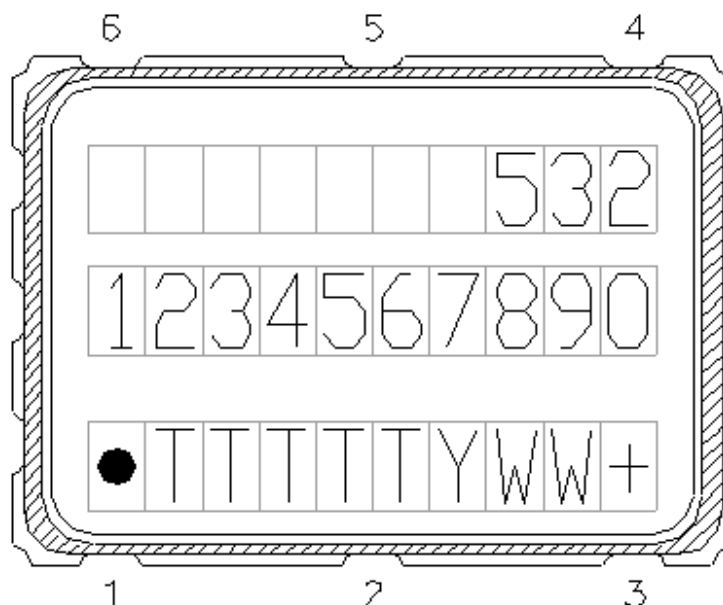

**Figure 3. Mark Specification**

**Table 12. Si53x Top Mark Description**

| Line | Position          | Description   |
|------|-------------------|---|
| 1    | 1–10              | “532”   |
| 2    | 1–10              | Si532: Option1 + Option2 + ConfigNum(6) + Temp                                      |
| 3    | <b>Trace Code</b> |   |
|      | Position 1        | Pin 1 orientation mark (dot)  |
|      | Position 2        | Product Revision (D)  |
|      | Position 3–6      | Tiny Trace Code (4 alphanumeric characters per assembly release instructions)       |
|      | Position 7        | Year (least significant year digit), to be assigned by assembly site (ex: 2007 = 7) |
|      | Position 8–9      | Calendar Work Week number (1–53), to be assigned by assembly site                   |
|      | Position 10       | “+” to indicate Pb-Free and RoHS-compliant  |

## 6. 6-Pin PCB Land Pattern

Figure 4 illustrates the 6-pin PCB land pattern for the Si532. Table 13 lists the values for the dimensions shown in the illustration.

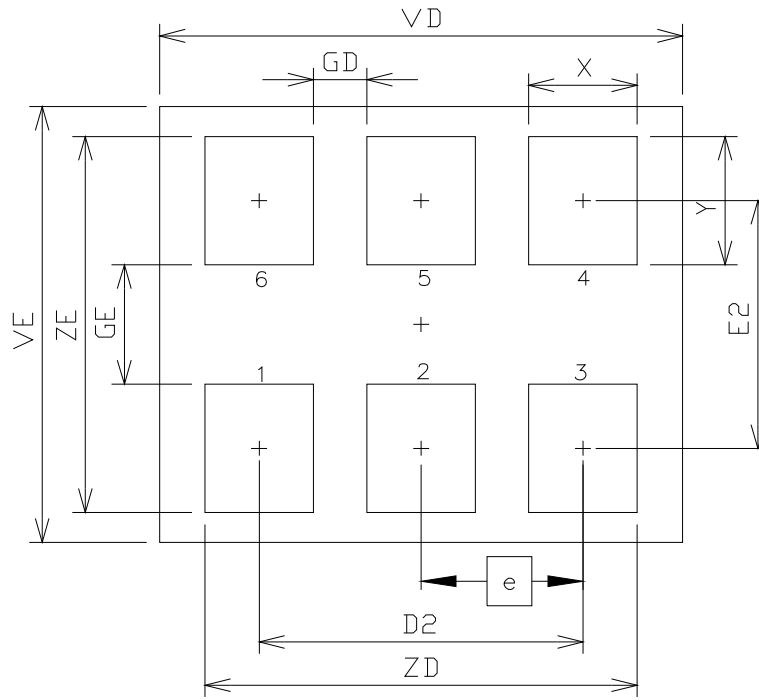

**Figure 4. Si532 PCB Land Pattern**

**Table 13. PCB Land Pattern Dimensions (mm)**

| Dimension | Min      | Max  |
|-----------|----------|------|
| D2        | 5.08 REF |      |
| e         | 2.54 BSC |      |
| E2        | 4.15 REF |      |
| GD        | 0.84     | —    |
| GE        | 2.00     | —    |
| VD        | 8.20 REF |      |
| VE        | 7.30 REF |      |
| X         | 1.70 TYP |      |
| Y         | 2.15 REF |      |
| ZD        | —        | 6.78 |
| ZE        | —        | 6.30 |

**Notes:**

1. Dimensioning and tolerancing per the ANSI Y14.5M-1994 specification.
2. Land pattern design based on IPC-7351 guidelines.
3. All dimensions shown are at maximum material condition (MMC).
4. Controlling dimension is in millimeters (mm).

## DOCUMENT CHANGE LIST

### Revision 1.0 to Revision 1.1

- Updated Table 1, “Recommended Operating Conditions,” on page 2.
  - Device maintains stable operation over –40 to +85 °C operating temperature range.
  - Supply current specifications updated for revision D.
- Updated Table 2, “CLK± Output Frequency Characteristics,” on page 2.
  - Added specification for ±20 ppm lifetime stability (±7 ppm temperature stability) XO.
- Updated Table 3, “CLK± Output Levels and Symmetry,” on page 3.
  - Updated LVDS differential peak-peak swing specifications.
- Updated Table 4, “CLK± Output Phase Jitter,” on page 4.
- Updated Table 5, “CLK± Output Period Jitter,” on page 4.
  - Revised period jitter specifications.
- Updated Table 9, “Absolute Maximum Ratings<sup>1</sup>,” on page 5 to reflect the soldering temperature time at 260 °C is 20–40 sec per JEDEC J-STD-020C.
- Updated 3. “Ordering Information” on page 7.
  - Changed ordering instructions to revision D.
- Added 5. “Si532 Mark Specification” on page 9.

### Revision 1.1 to Revision 1.2

- Updated 2.5 V/3.3 V and 1.8 V CML output level specifications for Table 3 on page 3.
- Added footnotes clarifying max offset frequency test conditions for Table 4 on page 4.
- Removed the words “Differential Modes: LVPECL/LVDS/CML” in the footnote referring to AN256 in Table 4 on page 4.
- Added CMOS phase jitter specs to Table 4 on page 4.
- Updated Table 7 on page 5 to include the “Moisture Sensitivity Level” and “Contact Pads” rows.
- Revised Figure 2 on page 8 to reflect current package outline diagram.
- Updated Figure 3 and Table 12 on page 9 to reflect specific marking information. Previously, Figure 3 was generic.

### Revision 1.2 to Revision 1.3

- Added Table 8, “Thermal Characteristics,” on page 5.

### Revision 1.3 to Revision 1.31

May 2, 2016

- Updated Table 4 to include 125 MHz and 156.25 MHz jitter measurements.

### Revision 1.31 to Revision 1.4

June, 2018

- Changed “Trays” to “Coil Tape” in section 3. “Ordering Information”.



## ClockBuilder Pro

One-click access to Timing tools, documentation, software, source code libraries & more. Available for Windows and iOS (CBGo only).

[skyworksinc.com/CBPro](http://skyworksinc.com/CBPro)



**Portfolio**

[skyworksinc.com](http://skyworksinc.com)



**SW/HW**

[skyworksinc.com/CBPro](http://skyworksinc.com/CBPro)

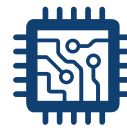

**Quality**

[skyworksinc.com/quality](http://skyworksinc.com/quality)



**Support & Resources**

[skyworksinc.com/support](http://skyworksinc.com/support)

**Copyright © 2022 Skyworks Solutions, Inc. All Rights Reserved.**

Information in this document is provided in connection with Skyworks Solutions, Inc. ("Skyworks") products or services. These materials, including the information contained herein, are provided by Skyworks as a service to its customers and may be used for informational purposes only by the customer. Skyworks assumes no responsibility for errors or omissions in these materials or the information contained herein. Skyworks may change its documentation, products, services, specifications or product descriptions at any time, without notice. Skyworks makes no commitment to update the materials or information and shall have no responsibility whatsoever for conflicts, incompatibilities, or other difficulties arising from any future changes.

No license, whether express, implied, by estoppel or otherwise, is granted to any intellectual property rights by this document. Skyworks assumes no liability for any materials, products or information provided hereunder, including the sale, distribution, reproduction or use of Skyworks products, information or materials, except as may be provided in Skyworks' Terms and Conditions of Sale.

THE MATERIALS, PRODUCTS AND INFORMATION ARE PROVIDED "AS IS" WITHOUT WARRANTY OF ANY KIND, WHETHER EXPRESS, IMPLIED, STATUTORY, OR OTHERWISE, INCLUDING FITNESS FOR A PARTICULAR PURPOSE OR USE, MERCHANTABILITY, PERFORMANCE, QUALITY OR NON-INFRINGEMENT OF ANY INTELLECTUAL PROPERTY RIGHT; ALL SUCH WARRANTIES ARE HEREBY EXPRESSLY DISCLAIMED. SKYWORKS DOES NOT WARRANT THE ACCURACY OR COMPLETENESS OF THE INFORMATION, TEXT, GRAPHICS OR OTHER ITEMS CONTAINED WITHIN THESE MATERIALS. SKYWORKS SHALL NOT BE LIABLE FOR ANY DAMAGES, INCLUDING BUT NOT LIMITED TO ANY SPECIAL, INDIRECT, INCIDENTAL, STATUTORY, OR CONSEQUENTIAL DAMAGES, INCLUDING WITHOUT LIMITATION, LOST REVENUES OR LOST PROFITS THAT MAY RESULT FROM THE USE OF THE MATERIALS OR INFORMATION, WHETHER OR NOT THE RECIPIENT OF MATERIALS HAS BEEN ADVISED OF THE POSSIBILITY OF SUCH DAMAGE

Skyworks products are not intended for use in medical, lifesaving or life-sustaining applications, or other equipment in which the failure of the Skyworks products could lead to personal injury, death, physical or environmental damage. Skyworks customers using or selling Skyworks products for use in such applications do so at their own risk and agree to fully indemnify Skyworks for any damages resulting from such improper use or sale.

Customers are responsible for their products and applications using Skyworks products, which may deviate from published specifications as a result of design defects, errors, or operation of products outside of published parameters or design specifications. Customers should include design and operating safeguards to minimize these and other risks. Skyworks assumes no liability for applications assistance, customer product design, or damage to any equipment resulting from the use of Skyworks products outside of Skyworks' published specifications or parameters.



Skyworks, the Skyworks symbol, Sky5®, SkyOne®, SkyBlue™, Skyworks Green™, Clockbuilder®, DSPLL®, ISOMODem®, ProSLIC®, and SiPHY® are trademarks or registered trademarks of Skyworks Solutions, Inc. or its subsidiaries in the United States and other countries. Third-party brands and names are for identification purposes only and are the property of their respective owners. Additional information, including relevant terms and conditions, posted at [www.skyworksinc.com](http://www.skyworksinc.com), are incorporated by reference.

Skyworks Solutions, Inc. | Nasdaq: SWKS | [sales@skyworksinc.com](mailto:sales@skyworksinc.com) | [www.skyworksinc.com](http://www.skyworksinc.com)

USA: 781-376-3000 | Asia: 886-2-2735 0399 | Europe: 33 (0)1 43548540

## Looking for pricing, stock, or lifecycle information?

Click below to explore more details on WIN SOURCE:

-  [View 532BB000603DG on WIN SOURCE](#)
-  [Skyworks Solutions Inc. Information](#)

## Optimize Your Supply Chain with WIN SOURCE Solutions

-  Global Sourcing Solution
-  Obsolete Management
-  Cost Control Management
-  Shortage Management
-  Alternative Solution
-  Excess Inventory Management