



**THE DATASHEET OF
4532-301-LF**



DATA SHEET

GAS DISCHARGE TUBES
TELEPHONE INTERFACE

4532 series

RoHS compliant & free



Product specification— July 12, 2023 V.1



Gas Discharge Tube (GDT) Data Sheet

Features

- High insulation resistance
- Low capacitance ($\leq 0.5\text{pF}$)
- 2KA 8/20 μs maximum surge current capacity in accordance with IEC 61000-4-5& IEC 61643-311
- 4KV 10/700 μs maximum surge rating in accordance with ITU-TK.21
- Surface mounted gas arrester
- Micro-Gap Design
- Size 4532(1812)
- Storage and operating temperature: $-40^{\circ}\text{C} \sim +90^{\circ}\text{C}$
- Meets MSL level 1, per J-STD-020
- Safety certification: UL & TUV



Applications

- Repeaters, Modems
- Telephone Interface, Line cards
- Data communication equipment
- Line test equipment

Part Number Code and Marking

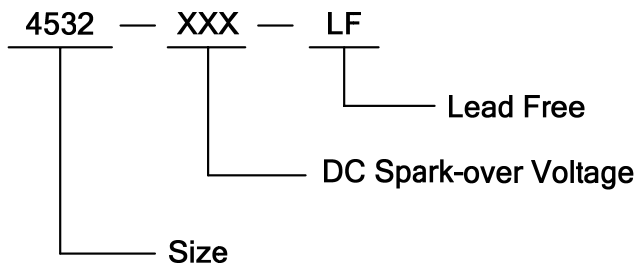

090: Device Marking Code

Dimensions

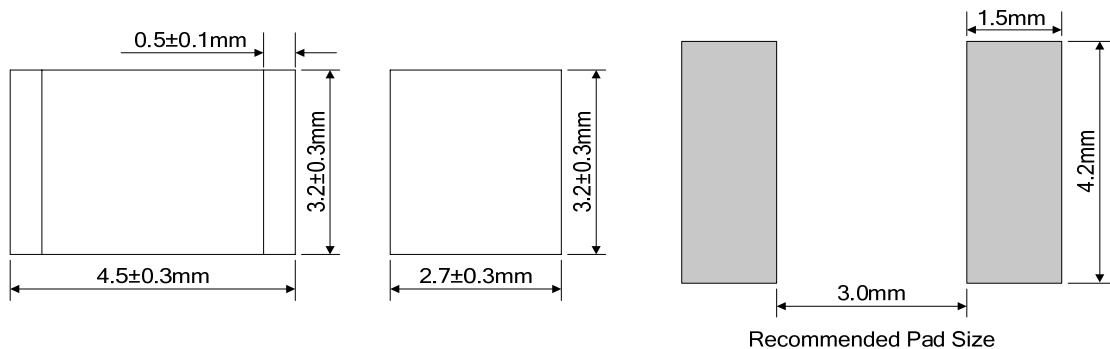

Electrical Characteristics

Part Number	DC Spark-over Voltage	Maximum Impulse Spark-over Voltage	Nominal Impulse Discharge Current	Impulse Withstanding Voltage Capacity	Minimum Insulation Resistance		Maximum Capacitance	Device Marking Code
	100V/s	1000V/ μ s	8/20 μ s 10times	10/700 μ s 10times	Test Voltage	(G Ω)	(1MHz 1V)	
	(V)	(V)	(KA)	(KV)	DC(V)		(pF)	
4532-075-LF	75 \pm 30%	600	2	4	50	1	0.5	075
4532-091-LF	90 \pm 30%	700	2	4	50	1	0.5	090
4532-121-LF	120 \pm 30%	700	2	4	50	1	0.5	120
4532-151-LF	150 \pm 30%	700	2	4	50	1	0.5	150
4532-201-LF	200 \pm 30%	750	2	4	100	1	0.5	200
4532-231-LF	230 \pm 30%	750	2	4	100	1	0.5	230
4532-301-LF	300 \pm 30%	900	2	4	100	1	0.5	300
4532-351-LF	350 \pm 30%	900	2	4	100	1	0.5	350
4532-401-LF	400 \pm 30%	1000	2	4	100	1	0.5	400
4532-421-LF	420 \pm 30%	1000	2	4	100	1	0.5	420
4532-471-LF	470 \pm 30%	1000	2	4	100	1	0.5	470
4532-501-LF	500 \pm 30%	1100	2	4	100	1	0.5	500
4532-601-LF	600 \pm 30%	1200	1	4	100	1	0.5	600
4532-801-LF	800 \pm 30%	1600	1	4	100	1	0.5	800
4532-1000-LF	1000 \pm 20%	2400	1	4	100	1	0.5	102
4532-1200-LF	1200 \pm 20%	2600	1	4	100	1	0.5	122
4532-1500-LF	1500 \pm 20%	2800	1	4	100	1	0.5	152

Electrical Ratings

Items	Test Condition/Description	Requirement
DC Spark-over Voltage	The voltage is measured with voltage ramp dv/dt=100V/s.	To meet the specified value
Maximum Impulse Spark-over Voltage	The maximum impulse spark-over voltage is measured with voltage ramp dv/dt=1000V/ μ s.	
Insulation Resistance	The resistance of gas tube shall be measured between two electrodes.	
Capacitance	The capacitance of gas tube shall be measured between two electrodes. Test frequency: 1MHz	
Impulse Discharge Current	Maximum 8/20 μ s surge current that can be applied between two electrodes, 5 positive and 5 negative surges, with 3 minutes interval time.	
Impulse Withstanding Voltage	The maximum 10/700 μ s surge that can be applied to the Gas Tube, 5 positive and 5 negative surges, with 1 minute interval time.	

Recommended Soldering Conditions

Reflow Soldering

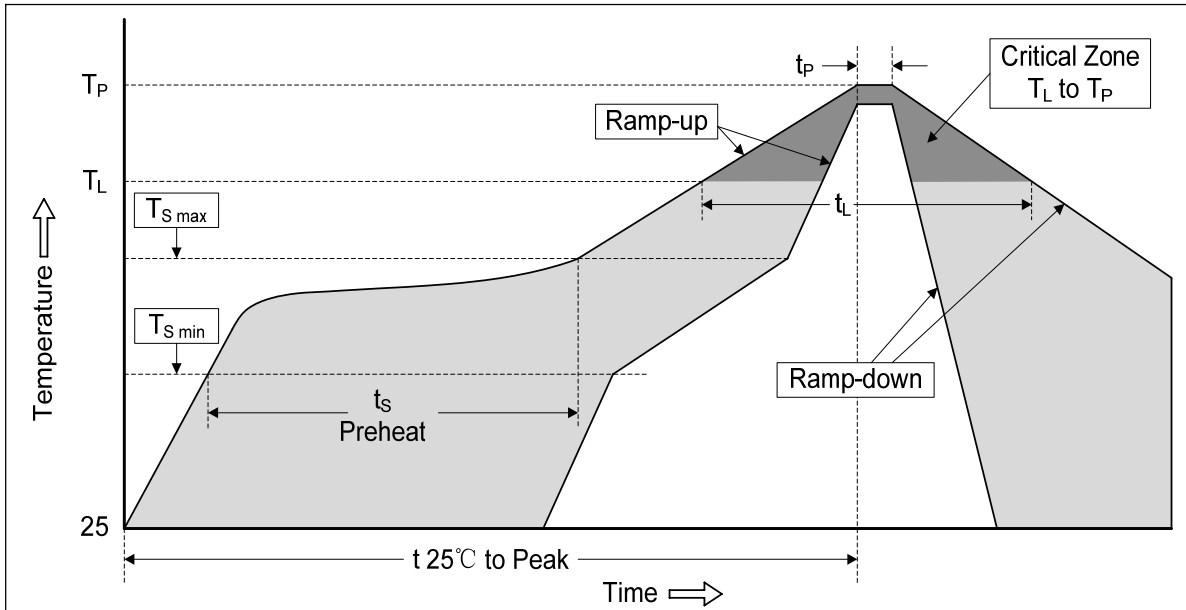

Profile Feature	Pb-Free Assembly
Average ramp-up rate (T _L to T _P)	3°C/second max.
Preheat -Temperature Min (T _{S min}) -Temperature Max (T _{S max}) -Time (min to max) (t _s)	150°C 200°C 60-180 seconds
T _{S max} to T _L -Ramp-up Rate	3°C/second max.
Time maintained above: -Temperature (T _L) -Time (t _L)	217°C 60-150 seconds
Peak Temperature (T _P)	260°C
Time within 5°C of actual Peak Temperature (t _P)	20-40 seconds
Ramp-down Rate	6°C/second max.
Time 25°C to Peak Temperature	8 minutes max.

Packaging

Tape

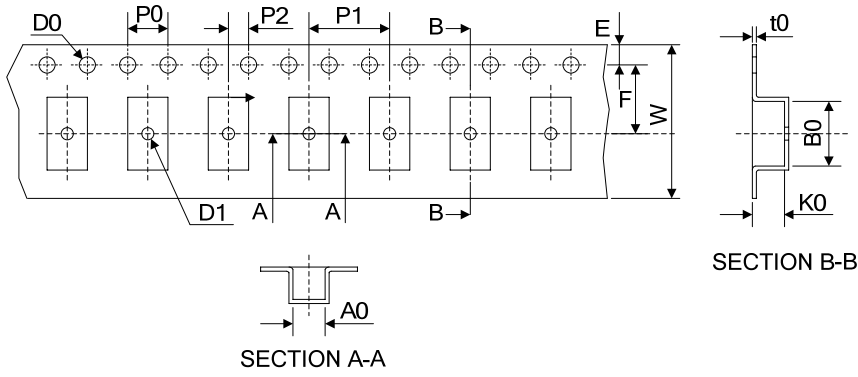

Items	Dimension (mm)	
	Spec.	Tolerance
W	12.00	±0.20
P0	4.00	±0.10
P1	8.00	±0.20
P2	2.00	±0.10
D0	1.55	±0.10
D1	1.00	±0.10
E	1.75	±0.10
F	5.50	±0.10
A0	3.80	±0.10
K0	3.20	±0.10
B0	4.90	±0.10
t0	0.40	±0.10
D	330.00	±2.00
d	13.00	±0.50
L	16.00	±2.00
t	2.00	±0.20
Quantity: 2500pcs		

Reel

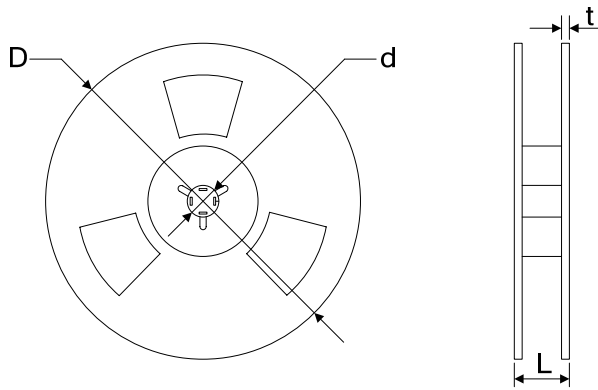

LEGAL DISCLAIMER

YAGEO, its distributors and agents (collectively, "YAGEO"), hereby disclaims any and all liabilities for any errors, inaccuracies or incompleteness contained in any product related information, including but not limited to product specifications, datasheets, pictures and/or graphics. YAGEO may make changes, modifications and/or improvements to product related information at any time and without notice.



YAGEO makes no representation, warranty, and/or guarantee about the fitness of its products for any particular purpose or the continuing production of any of its products. To the maximum extent permitted by law, YAGEO disclaims (i) any and all liability arising out of the application or use of any YAGEO product, (ii) any and all liability, including without limitation special, consequential or incidental damages, and (iii) any and all implied warranties, including warranties of fitness for a particular purpose, non-infringement and merchantability.

YAGEO products are designed for general purpose applications under normal operation and usage conditions. Please contact YAGEO for the applications listed below which require especially high reliability for the prevention of defects which might directly cause damage to the third party's life, body or property: Aerospace equipment (artificial satellite, rocket, etc.), Atomic energy-related equipment, Aviation equipment, Disaster prevention equipment, crime prevention equipment, Electric heating apparatus, burning equipment, Highly public information network equipment, data-processing equipment, Medical devices, Military equipment, Power generation control equipment, Safety equipment, Traffic signal equipment, Transportation equipment and Undersea equipment, or for any other application or use in which the failure of YAGEO products could result in personal injury or death, or serious property damage. Particularly **YAGEO Corporation and its affiliates do not recommend the use of commercial or automotive grade products for high reliability applications or manned space flight.**

Information provided here is intended to indicate product specifications only. YAGEO reserves all the rights for revising this content without further notification, as long as products are unchanged. Any product change will be announced by PCN.

Looking for pricing, stock, or lifecycle information?

Click below to explore more details on WIN SOURCE:

-  [View 4532-301-LF on WIN SOURCE](#)
-  [Yageo Information](#)

Optimize Your Supply Chain with WIN SOURCE Solutions

-  Global Sourcing Solution
-  Obsolete Management
-  Cost Control Management
-  Shortage Management
-  Alternative Solution
-  Excess Inventory Management