



**THE DATASHEET OF
3SU14011ME301DA1**









Siemens
EcoTech



SIRIUS ACT: terminal module (LED module), integrated LED yellow, for front plate mounting



product brand name	SIRIUS ACT
product designation	Terminal module
design of the product	with integrated LED
product type designation	3SU1
Display	
display version	
<ul style="list-style-type: none"> for diagnostic function: Supply voltage monitoring power LED 	Yes
<ul style="list-style-type: none"> status Tx/Rx link 	No
General technical data	
product function	
<ul style="list-style-type: none"> reverse polarity protection 	Yes; Ribbon cable can be rotated 180°.
<ul style="list-style-type: none"> diagnostics function 	Yes
firmware version	1.0.0
hardware version	1
software version with STEP 7 in the TIA Portal required	V13 SP1 (V13 SP1 and V14 with HSP0132)
power loss [W] typical	0.115 W
degree of pollution	3
type of voltage	
<ul style="list-style-type: none"> of the operating voltage 	DC
<ul style="list-style-type: none"> of the input voltage 	DC
surge voltage resistance rated value	0.8 kV
consumed current	
<ul style="list-style-type: none"> maximum 	27 mA
<ul style="list-style-type: none"> rated value 	23 mA
protection class IP	IP20
shock resistance	
<ul style="list-style-type: none"> according to IEC 60068-2-27 	sinusoidal half-wave 15g / 11 ms
<ul style="list-style-type: none"> for railway applications according to EN 61373 	Category 1, Class B
vibration resistance	
<ul style="list-style-type: none"> according to IEC 60068-2-6 	10 ... 500 Hz: 5g
<ul style="list-style-type: none"> for railway applications according to EN 61373 	Category 1, Class B
reference code according to IEC 81346-2	K
Substance Prohibitance (Date)	12/19/2016
SVHC substance name	Lead - 7439-92-1 Lead monoxide (lead oxide) - 1317-36-8
Communication/ Protocol	
protocol is supported	

• PROFIsafe protocol	No	
Connections/ Terminals		
type of electrical connection	Insulation displacement connection	
type of connectable conductor cross-sections	Ribbon cable 7-pole, 7 x 0.08 mm ²	
connectable conductor cross-section for auxiliary contacts		
• solid or stranded	0.08 ... 0.08 mm ²	
• finely stranded with core end processing maximum	0.08 mm ²	
connectable conductor cross-section		
• solid	0.08 ... 0.08 mm ²	
• solid with core end processing	0.08 ... 0.08 mm ²	
• finely stranded with core end processing	0.08 ... 0.08 mm ²	
• finely stranded without core end processing	0.08 ... 0.08 mm ²	
AWG number as coded connectable conductor cross section	28 ... 28	
Lamp		
color of the light source	yellow	
Safety related data		
service life maximum	20 a	
Ambient conditions		
ambient temperature		
• during operation	-25 ... +60 °C	
• during storage	-40 ... +80 °C	
environmental category during operation according to IEC 60721	3M6, 3S2, 3B2, 3K6 (with relative air humidity of 10 ... 95%, no condensation in operation permitted)	
explosion protection marking for intrinsic safety of related equipment EEx ia	No	
explosion protection marking for intrinsic safety of related equipment EEx ib	No	
Environmental footprint		
Environmental Product Declaration (EPD)	Yes	
Global Warming Potential [CO ₂ eq] total	0.787 kg	
Global Warming Potential [CO ₂ eq] during manufacturing	0.566 kg	
Global Warming Potential [CO ₂ eq] during operation	0.235 kg	
Global Warming Potential [CO ₂ eq] after end of life	-0.015 kg	
Siemens Eco Profile (SEP)	Siemens EcoTech	
Installation/ mounting/ dimensions		
fastening method of modules and accessories	Front plate mounting	
height	32.6 mm	
width	30 mm	
depth	31.5 mm	
Approvals Certificates		
General Product Approval	Test Certificates	
<p>Confirmation</p>     <p style="text-align: right;">Type Test Certificates/Test Report</p>		
Test Certificates	other	Environment
Special Test Certificate	Confirmation	  <p style="text-align: right;">Environmental Confirmations</p>
Further information		
<p>Information on the packaging https://support.industry.siemens.com/cs/ww/en/view/109813875 Information- and Downloadcenter (Catalogs, Brochures,...) https://www.siemens.com/ic10 Industry Mall (Online ordering system) https://mall.industry.siemens.com/mall/en/en/Catalog/product?mifb=3SU1401-1ME30-1DA1 Cax online generator</p>		

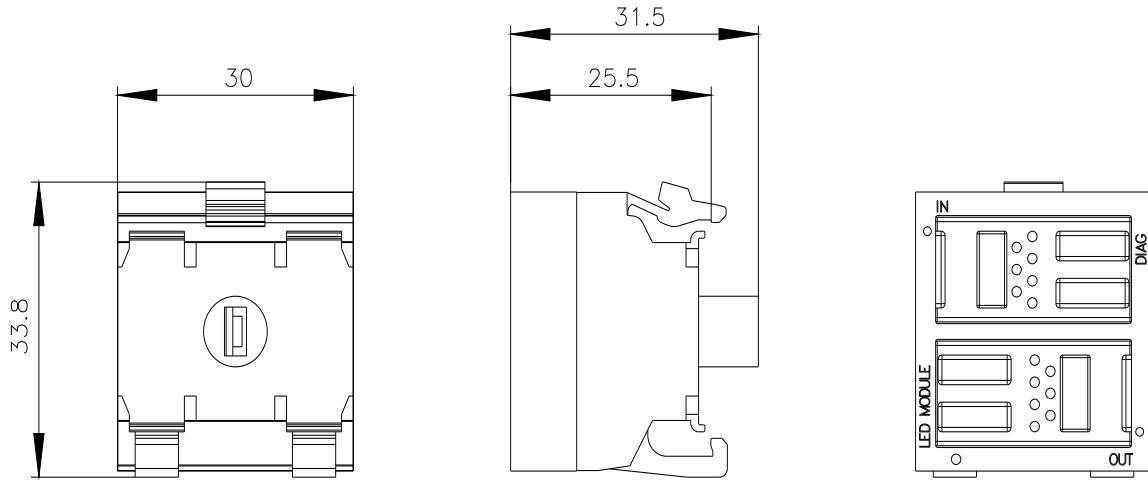

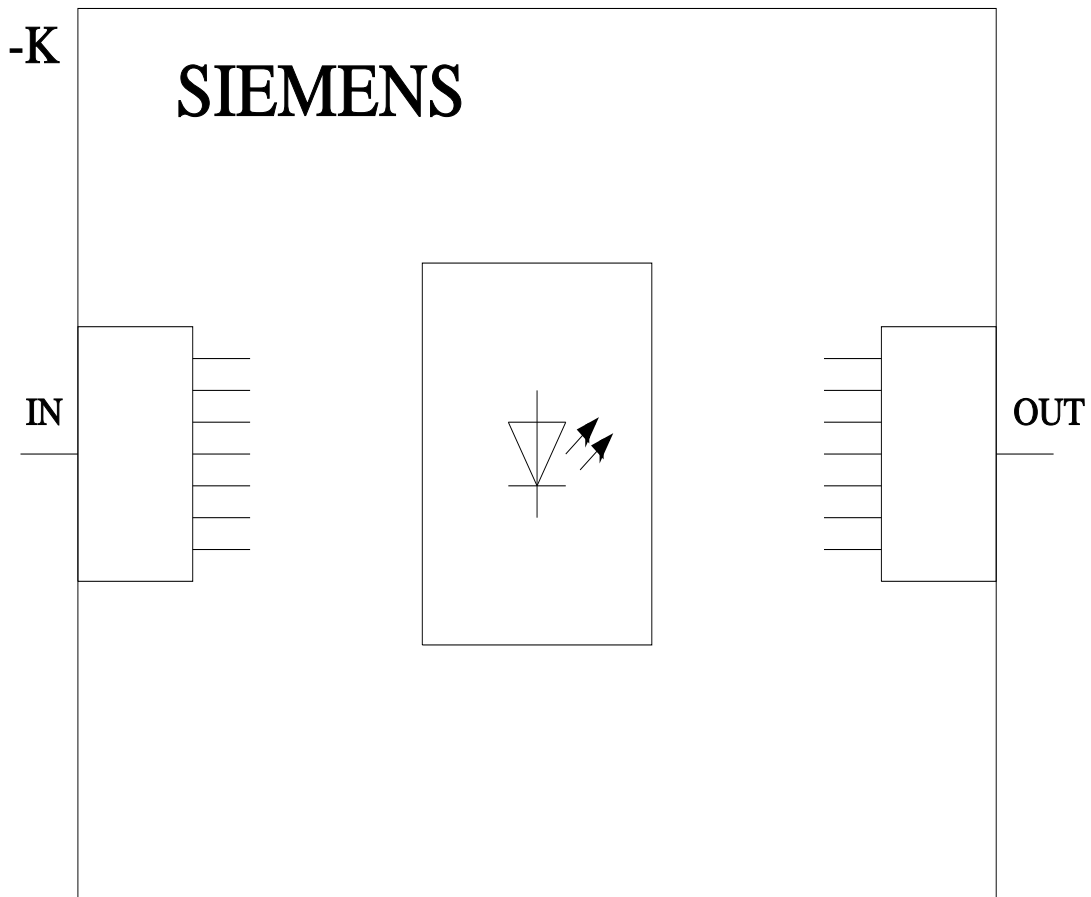



last modified:

3/11/2024

Looking for pricing, stock, or lifecycle information?

Click below to explore more details on WIN SOURCE:

-  [View 3SU14011ME301DA1 on WIN SOURCE](#)
-  [Siemens Information](#)

Optimize Your Supply Chain with WIN SOURCE Solutions

-  Global Sourcing Solution
-  Obsolete Management
-  Cost Control Management
-  Shortage Management
-  Alternative Solution
-  Excess Inventory Management