



**THE DATASHEET OF
BPA04SB**



BPA Series Side Actuated DIP Switches

INDUSTRIAL
ELECTRONICS

DIP

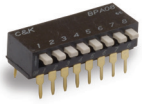

Features/Benefits

- Side actuated contacts
- Available in thru-hole or SMT models
- High pressure contact system does not require tape seal for washing
- RoHS compliant & compatible

Typical Applications

- Address switch for industrial controls
- Logic switching for computers and peripherals
- Function controlling for numerous applications

Specifications

SWITCH FUNCTION: 1 thru 10 and 12 position available.

CONTACT RATING: 100 mA max. @ 5 V DC or 25 mA max. @ 24 V DC.

MECHANICAL AND ELECTRICAL LIFE: 1,000 cycles min. @ 5 V DC 10mA.

CONTACT RESISTANCE: 50 milliohms initial max.

INSULATION RESISTANCE: 100 V DC 100 megohms min.

DIELECTRIC WITHSTAND VOLTAGE: 300 V AC for 1 minute.

STORAGE TEMPERATURE: -40°C to 85°C.

OPERATING TEMPERATURE: -20°C to 85°C.

OPERATING FORCE: 800 grams max.

SOLDERABILITY: Flow solderable and washable (soldering: 260°C for 10 sec. max.)

PACKAGING: Switches supplied in rigid dispensing tubes in full-tube quantities only, this may affect order quantity. Numbers of switches per tube varies with model. Tape and reel packaging available for SMT options.

Materials

HOUSING: PPS, color black (UL94V-0).

COVER: PPS, color black (UL94V-0).

ACTUATOR: PA-6T (UL94V-0).

CONTACTS: Beryllium Copper with Gold over Nickel plate.

TERMINALS: Brass, Gold over Nickel plate.

Note: Specifications and materials listed above are for switches with standard options. For information on specific and custom switches, consult Customer Service Center.

How To Order

The Build-A Switch concept allows you to mix and match options to create the switch you need. Below is a complete listing of options shown in catalog. To order, simply select desired option from each category and place in the appropriate box.

All switches supplied in "OFF" position.

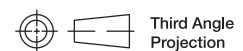
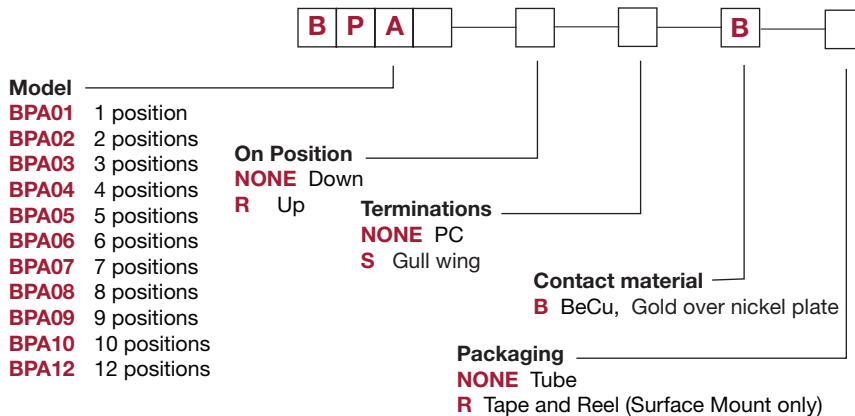

Dimensions are shown: Inch (mm)

Specifications and dimensions subject to change

BPA Series Side Actuated DIP Switches

Side Actuator – Thru-hole Terminals

| ROHS PART NUMBER | NO. POS. | DIM. 'A' | DIM. 'B' | QUANTITY PER TUBE |
|------------------|----------|--------------|---------------|-------------------|
| BPA01B | 1 | .176 (4,48) | N/A | 100 |
| BPA02B | 2 | .276 (7,0) | .100 (2,54) | 60 |
| BPA03B | 3 | .376 (9,6) | .200 (5,08) | 45 |
| BPA04B | 4 | .476 (12,1) | .300 (7,62) | 35 |
| BPA05B | 5 | .575 (14,6) | .400 (10,16) | 30 |
| BPA06B | 6 | .677 (17,2) | .500 (12,70) | 25 |
| BPA07B | 7 | .776 (19,7) | .600 (15,24) | 20 |
| BPA08B | 8 | .878 (22,3) | .700 (17,78) | 20 |
| BPA09B | 9 | .976 (24,8) | .800 (20,32) | 15 |
| BPA10B | 10 | 1.075 (27,3) | .900 (22,86) | 15 |
| BPA12B | 12 | 1.280 (32,5) | 1.100 (27,94) | 14 |

Schematic

SPST

NOTE: Reverse throw available, contact C&K for P/N and quote.



BPA08B

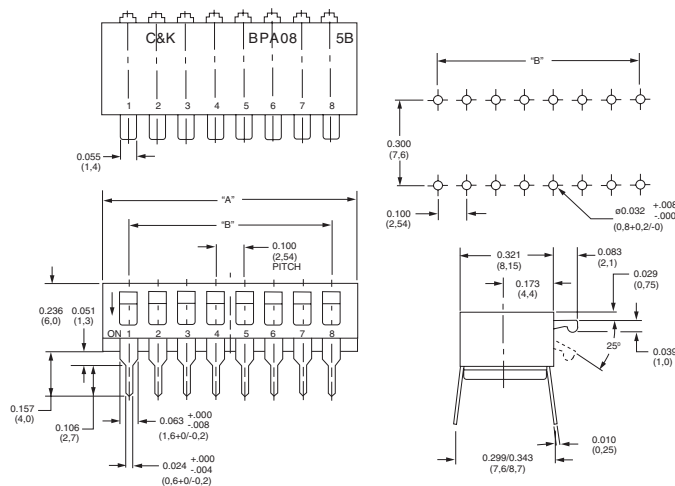

Side Actuator – Surface Mount Terminals

| ROHS PART NUMBER | NO. POS. | DIM. 'A' | DIM. 'B' | QUANTITY PER TUBE |
|------------------|----------|--------------|---------------|-------------------|
| BPA01SB | 1 | .176 (4,48) | N/A | 100 |
| BPA02SB | 2 | .276 (7,0) | .100 (2,54) | 60 |
| BPA03SB | 3 | .376 (9,6) | .200 (5,08) | 45 |
| BPA04SB | 4 | .476 (12,1) | .300 (7,62) | 35 |
| BPA05SB | 5 | .575 (14,6) | .400 (10,16) | 30 |
| BPA06SB | 6 | .677 (17,2) | .500 (12,70) | 25 |
| BPA07SB | 7 | .776 (19,7) | .600 (15,24) | 20 |
| BPA08SB | 8 | .878 (22,3) | .700 (17,78) | 20 |
| BPA09SB | 9 | .976 (24,8) | .800 (20,32) | 15 |
| BPA10SB | 10 | 1.075 (27,3) | .900 (22,86) | 15 |
| BPA12SB | 12 | 1.280 (32,5) | 1.100 (27,94) | 14 |

Schematic

SPST

NOTE: Tape and reel packaging available by adding "R" to end of project number.



BPA08SB

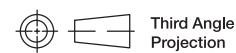
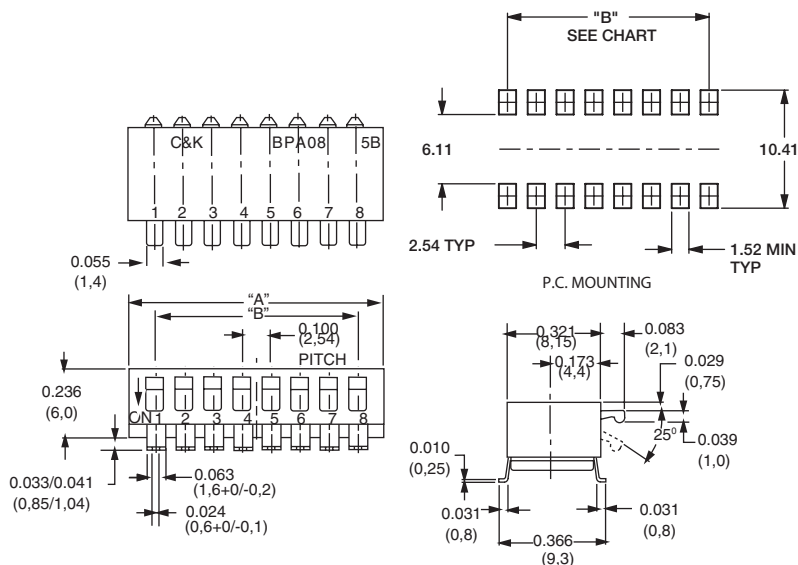

Dimensions are shown: Inch (mm)
Specifications and dimensions subject to change

BPA Series Side Actuated DIP Switches

DIP H

Tape & Reel Packaging – Surface Mount Options Only

| QTY/ REEL | POLES | DIM. 'A' | DIM. 'B' | DIM. 'C' | DIM. 'D' | DIM. 'E' |
|--------------|-------|-------------|--------------|--------------|--------------|--------------|
| 500 | 1 | .453 (11,5) | — | .945 (24,0) | .530 (13,45) | .960 (24,4) |
| 500 | 2 | .453 (11,5) | — | .945 (24,0) | .311 (7,9) | .960 (24,4) |
| 500 | 3 | .453 (11,5) | — | .945 (24,0) | .409 (10,4) | .960 (24,4) |
| 500 | 4 | .453 (11,5) | — | .945 (24,0) | .508 (12,9) | .960 (24,4) |
| 500 | 5 | .453 (11,5) | — | .945 (24,0) | .606 (15,4) | .960 (24,4) |
| 500 | 6 | .559 (14,2) | 1.118 (28,4) | 1.260 (32,0) | .709 (18,0) | 1.275 (32,4) |
| 500 | 7 | .559 (14,2) | 1.118 (28,4) | 1.260 (32,0) | .807 (20,5) | 1.275 (32,4) |
| 500 | 8 | .795 (20,2) | 1.590 (40,4) | 1.732 (44,0) | .894 (22,7) | 1.748 (44,4) |
| 500 | 9 | .795 (20,2) | 1.590 (40,4) | 1.732 (44,0) | 1.004 (25,5) | 1.748 (44,4) |
| 500 | 10 | .795 (20,2) | 1.590 (40,4) | 1.732 (44,0) | 1.106 (28,1) | 1.748 (44,4) |
| 500 | 12 | .795 (20,2) | 1.590 (40,4) | 1.732 (44,0) | 1.311 (33,3) | 1.748 (44,4) |

Note: For tape and reel packaging, add 'R' to end of part number.

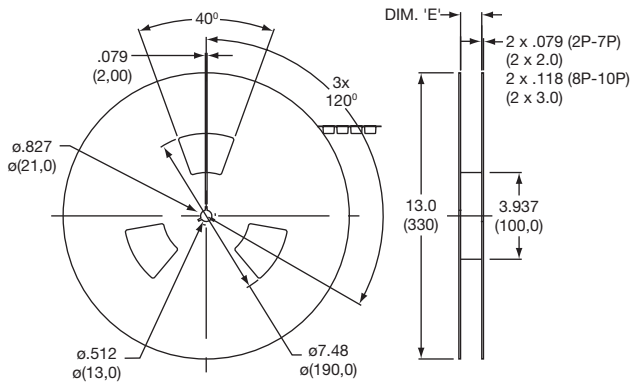

2, 3, 4 & 5 Positions

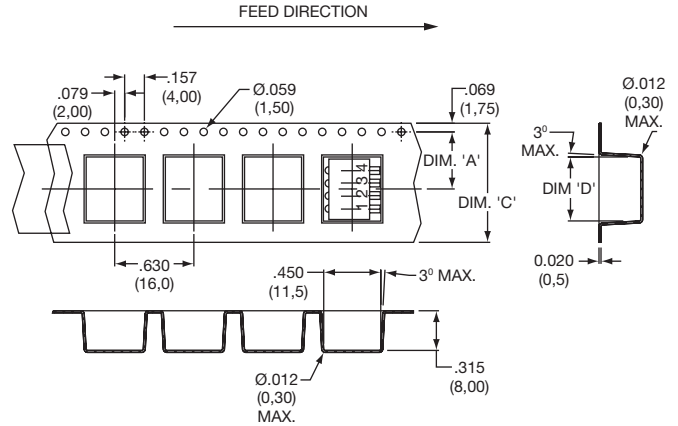

6, 7, 8, 9, 10 & 12 Positions

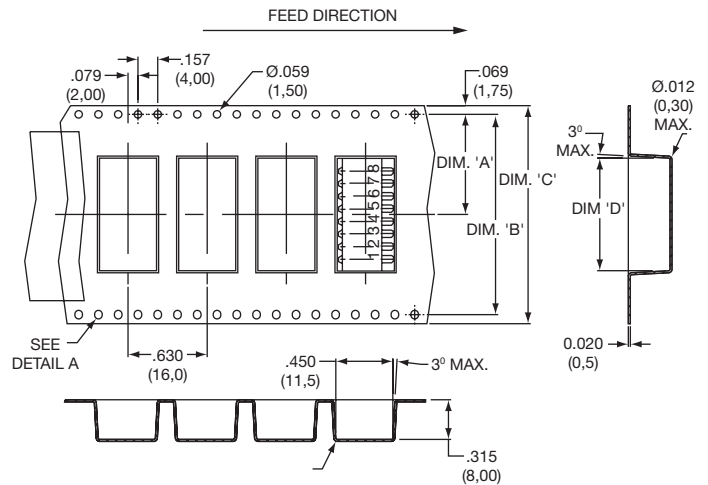

Tube Packaging

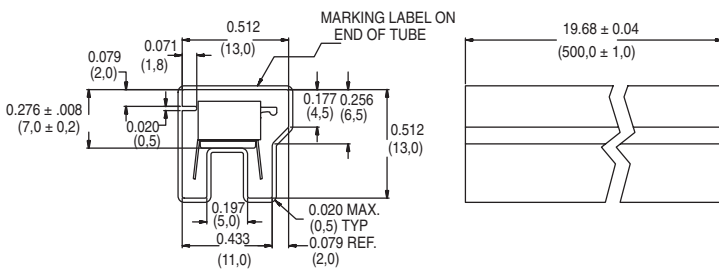

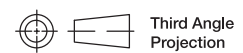
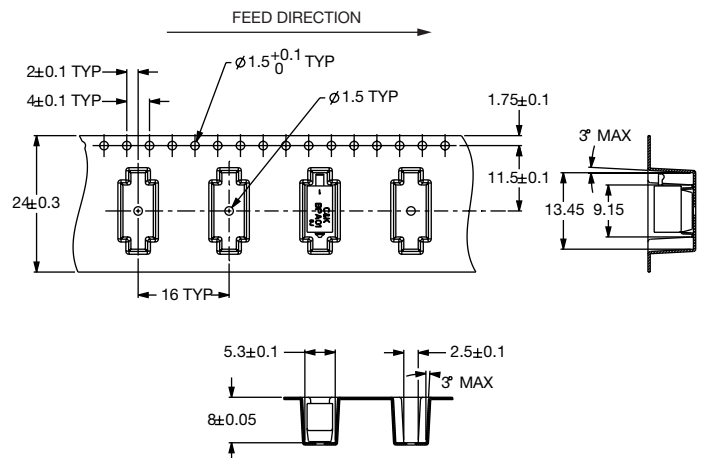

1 Position



Third Angle Projection
Dimensions are shown: Inch (mm)
Specifications and dimensions subject to change

Looking for pricing, stock, or lifecycle information?

Click below to explore more details on WIN SOURCE:

-  [View BPA04SB](#) on WIN SOURCE
-  [C&K Components](#) Information

Optimize Your Supply Chain with WIN SOURCE Solutions

-  Global Sourcing Solution
-  Obsolete Management
-  Cost Control Management
-  Shortage Management
-  Alternative Solution
-  Excess Inventory Management