

0 to 19V/300mA Output

Broad output DC/DC Converter(Non-isolated)

BP5811

Absolute Maximum Ratings

Parameter	Symbol	Limits	Unit
Motor driving supply voltage	V_{Min}	25	V
CTL input voltage	V_{CTL}	0.3 to 5.5	V
Maximum output current	I_{Opeak}	300	mA
Operating temperature range	T_{opr}	-20 to +80	°C
Storage temperature range	T_{stg}	-30 to +85	°C
Maximum surface temperature	T_{cmax}	100	°C

Recommended Action Conditions

Parameter	Symbol	Min.	Typ.	Max.	Unit	Conditions
Motor driving supply voltage	V_{MIN}	19.0	20.0	21.0	V	$I_O=300mA$
CTL input voltage	V_{ctl}	0	-	5.0	V	
CTL input frequency	f_{ctl}	1	50	100	kHz	

Electrical Characteristics

(Unless otherwise specified, $V_{MIN}=20V$, $I_O=300mA$, $V_{CTL}=5.0V$, $T_a=25^\circ C$)

Parameter	Symbol	Min.	Typ.	Max.	Unit	Conditions
Output voltage	V_O	18.0	19.0	20.0	V	
		14.3	15.1	15.9	V	$V_{ctl}=4.0V$ $I_O=240mA$
		6.76	7.35	7.94	V	$V_{ctl}=2.0V$ $I_O=120mA$
Output current	I_O	-	-	300	mA	*1
Output ripple	V_P	-	0.05	0.15	V _{p-p}	*2
Power conversion efficiency	η	88	93	-	%	

*1 Maximum output current is charged due to the output voltage or the ambient temperature.

*2 An output ripple voltage is charged due to smooth capacitor, measurement environment, pattern layout.

Application Circuit

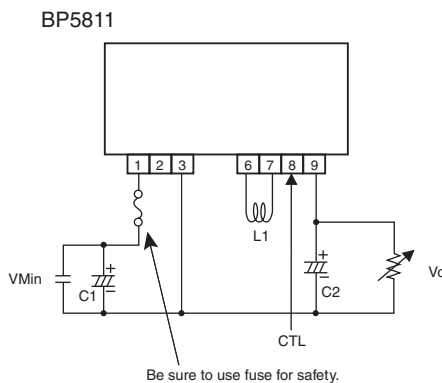

Pin No.	Function
1	Input terminal
2	N.C.
3	GND
4	Skip
5	Skip
6	Coil connection terminal
7	Coil connection terminal
8	Control terminal
9	Output voltage

External Component Specifications

FUSE: Fuse	Use a quick-acting fuse (2.3A)
C1: Input smoothing capacitor	470 μ F/50V Low impedance Recommended part : PM series (Nichicon)
C2: Output smoothing capacitor	470 μ F/50V Low impedance Recommended part : PM series (Nichicon)
L1: Power inductor	47 μ H, Rated current 1.2A or higher Recommended part : TSL0808-470K1R2 (TDK)

Dimensions (Unit : mm)

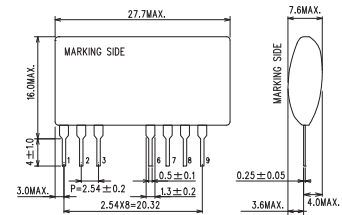

Derating Curve

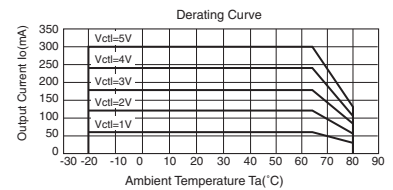

Output Voltage Control Characteristics (Ta=25°C)

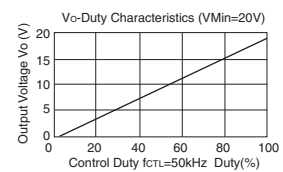
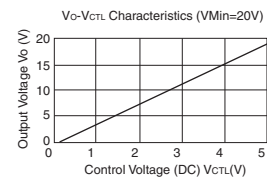

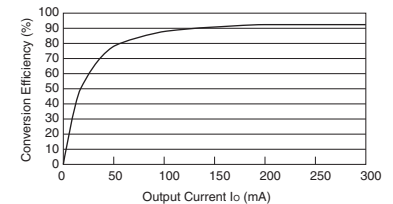

Conversion Efficiency (V_Min=20V, V_CTL=5V)





Looking for pricing, stock, or lifecycle information?

Click below to explore more details on WIN SOURCE:

-  [View BP5811](#) on WIN SOURCE
-  [Rohm Semiconductor](#) Information

Optimize Your Supply Chain with WIN SOURCE Solutions

-  Global Sourcing Solution
-  Obsolete Management
-  Cost Control Management
-  Shortage Management
-  Alternative Solution
-  Excess Inventory Management