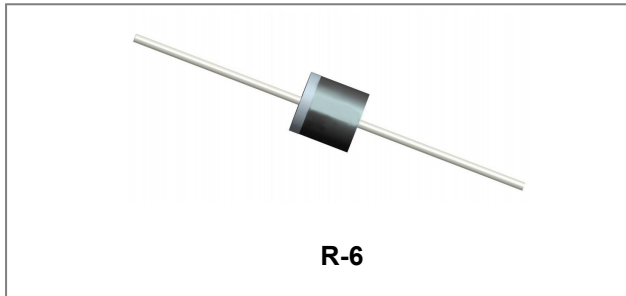




**THE DATASHEET OF**  
**15SQ045**



## 15SQ SERIES SCHOTTKY BARRIER RECTIFIER



### Features

- Super-high speed & low noise switching
- Low voltage drop
- Terminals finish: Tin Lead-free plated
- This is a Pb – Free Device
- All SMC parts are traceable to the wafer lot
- Additional testing can be offered upon request

### Circuit Diagram



### Mechanical Data

- DC-DC converters
- AC adapter
- High frequency rectification circuit
- Bypass diodes

### Maximum Ratings:

Characteristics	Symbol	Conditions	Value	Units
Peak Repetitive Reverse Voltage Working Peak Reverse Voltage DC Blocking Voltage	$V_{RRM}$ $V_{RWM}$ $V_R$	-	15SQ030	30
			15SQ045	45
			15SQ050	50
			15SQ060	60
			15SQ100	100
Average Rectified Forward Current	$I_{F(AV)}$	R- load, $T_a=50^\circ\text{C}$	15	A
Surge(Non-repetitive) Forward Current	$I_{FSM}$	8.3ms single half sine-wave	15SQ030	300
			15SQ045	
			15SQ050	
			15SQ060	
			15SQ100	340

### Electrical Characteristics:

Characteristics	Symbol	Conditions	Typ.	Max.	Units		
Peak Forward Voltage*	$V_{FM}$	$I_{FM}=15.0\text{A}, T_a=25^\circ\text{C}$	15SQ030	0.52	0.55		
			15SQ045	0.52	0.55		
			15SQ050	0.58	0.68		
			15SQ060	0.58	0.68		
			15SQ100	0.78	0.83		
Peak Reverse Current*	$I_{RRM1}$	$V_{RM}=V_{RRM}$	-	-	$T_a=25^\circ\text{C}$	0.05	0.5
	$I_{RRM2}$				$T_a=100^\circ\text{C}$	-	25
Thermal Resistance	$R_{\theta J-C}$	Between junction and case	-	3.0	-		
	$R_{\theta J-L}$	Between junction and lead	-	2.0	-		

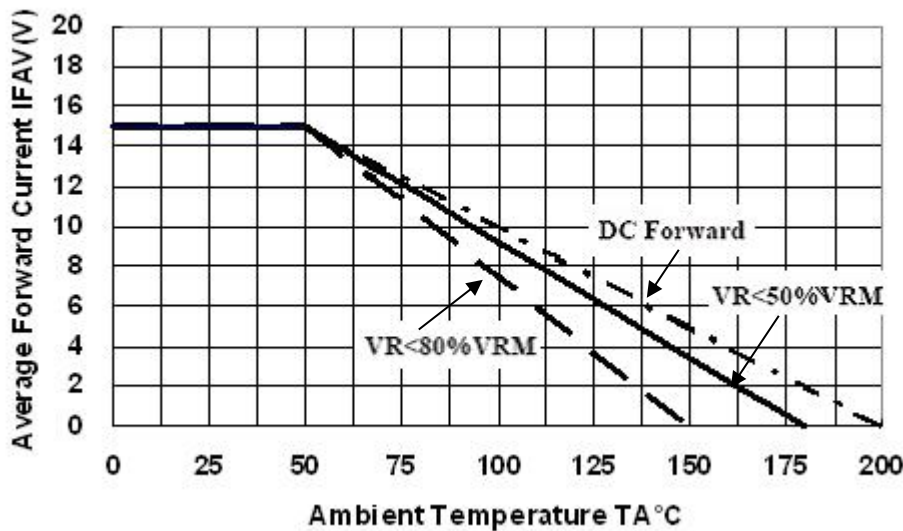
\* Pulse width < 300  $\mu\text{s}$ , duty cycle < 2%

- China - Germany - Korea - Singapore - United States •
- <http://www.smc-diodes.com> - [sales@smc-diodes.com](mailto:sales@smc-diodes.com) •

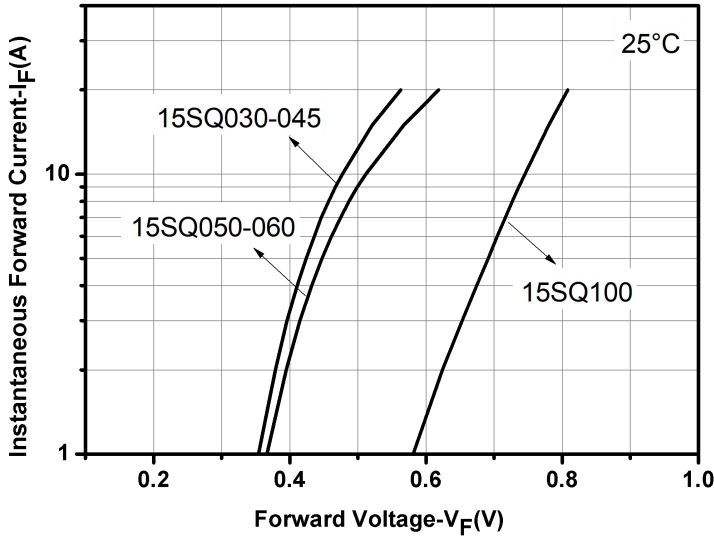
**Thermal-Mechanical Specifications:**

Characteristics	Symbol	Condition	Specification	Units
Max. Junction Temperature at reduced reverse voltage at reduced reverse voltage in DC forward mode	$T_J$	$V_R \leq 80\%V_{RRM}$ $V_R \leq 50\%V_{RRM}$	-55 to +150 -55 to +180 -55 to +200	$^{\circ}\text{C}$
Max. Storage Temperature	$T_{stg}$	-	-55 to +150	$^{\circ}\text{C}$
Approximate Weight	wt	-	2.24	g

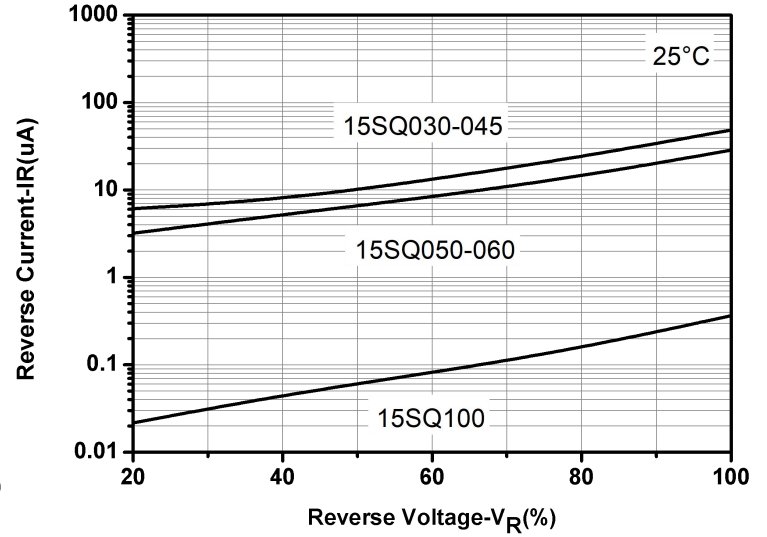
**Ratings and Characteristics Curves**



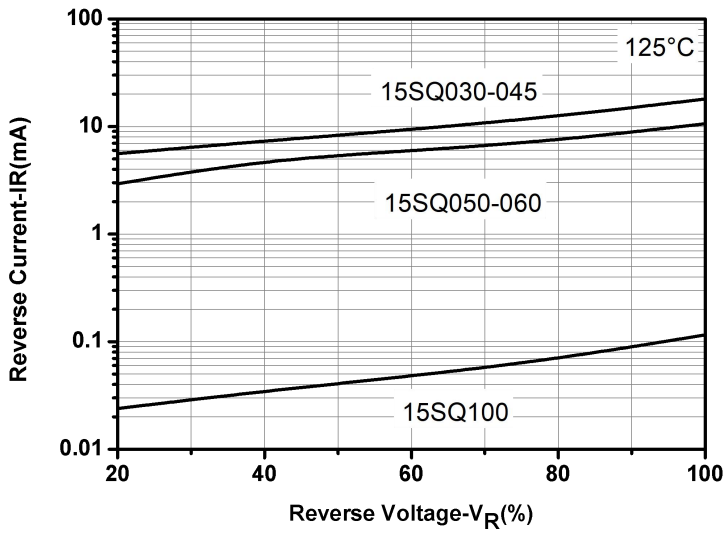
**Fig.1 Current Derating**



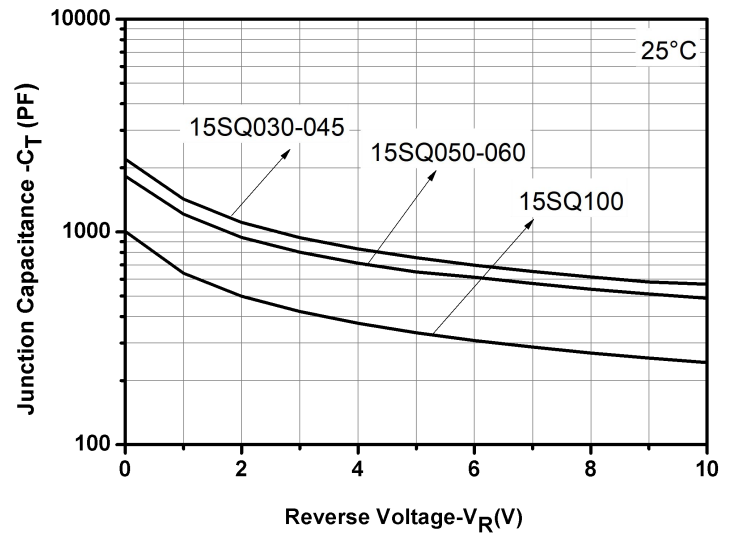
**Fig.2 Typical Forward Characteristics**



**Fig.3 Typical Reverse Characteristics**

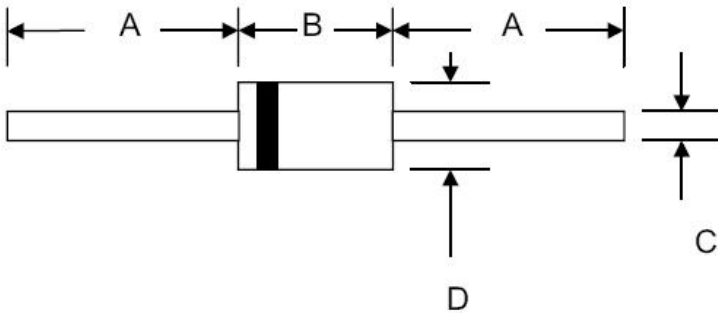


**Fig.4 Typical Reverse Characteristics**



**Fig.5 Typical Junction Capacitance**

**Mechanical Dimensions R-6**



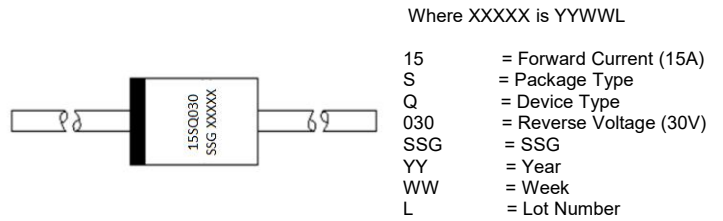
SYMBOL	Millimeters		Inches	
	Min.	Max.	Min.	Max.
A	25.4	-	1.000	-
B	8.60	9.10	0.340	0.360
C	1.2	1.3	0.048	0.052
D	8.60	9.10	0.340	0.360

**Ordering Information**

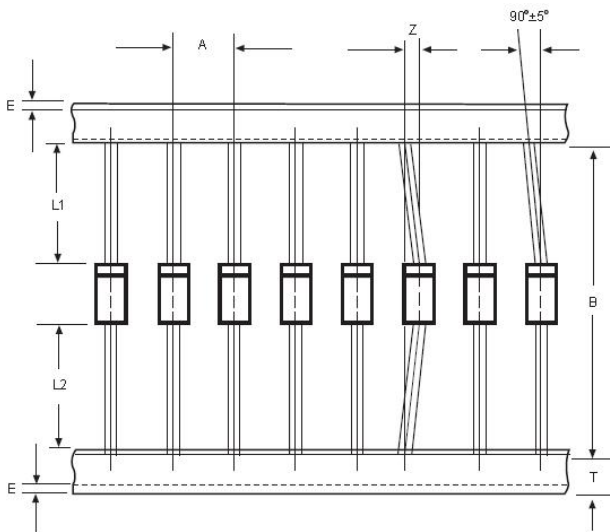
Device	Package	Shipping
15SQ030	R-6 (Pb-Free)	500pcs / reel
15SQ045		
15SQ050		
15SQ060		
15SQ100		

For information on tape and reel specifications, including part orientation and tape sizes, please refer to our tape and reel packaging specification.

**Marking Diagram**



**Carrier Tape Specification R-6**





SYMBOL	Millimeters	
	Min.	Max.
A	9.50	10.50
B	50.9	53.9
Z	-	1.20
T	5.60	6.40
E	-	0.80
IL1-L2I	-	1.0

**DISCLAIMER:**

- 1- The information given herein, including the specifications and dimensions, is subject to change without prior notice to improve product characteristics. Before ordering, purchasers are advised to contact the SMC Diode Solutions sales department for the latest version of the datasheet(s).
- 2- In cases where extremely high reliability is required (such as use in nuclear power control, aerospace and aviation, traffic equipment, medical equipment, and safety equipment), safety should be ensured by using semiconductor devices that feature assured safety or by means of users' fail-safe precautions or other arrangement.
- 3- In no event shall SMC Diode Solutions be liable for any damages that may result from an accident or any other cause during operation of the user's units according to the datasheet(s). SMC Diode Solution assumes no responsibility for any intellectual property claims or any other problems that may result from applications of information, products or circuits described in the datasheets.
- 4- In no event shall SMC Diode Solutions be liable for any failure in a semiconductor device or any secondary damage resulting from use at a value exceeding the absolute maximum rating.
- 5- No license is granted by the datasheet(s) under any patents or other rights of any third party or SMC Diode Solutions.
- 6- The datasheet(s) may not be reproduced or duplicated, in any form, in whole or part, without the expressed written permission of SMC Diode Solutions.
- 7- The products (technologies) described in the datasheet(s) are not to be provided to any party whose purpose in their application will hinder maintenance of international peace and safety nor are they to be applied to that purpose by their direct purchasers or any third party. When exporting these products (technologies), the necessary procedures are to be taken in accordance with related laws and regulations.

## Looking for pricing, stock, or lifecycle information?

Click below to explore more details on WIN SOURCE:

-  [View 15SQ045](#) on WIN SOURCE
-  [SMC Diode Solutions](#) Information

## Optimize Your Supply Chain with WIN SOURCE Solutions

-  Global Sourcing Solution
-  Obsolete Management
-  Cost Control Management
-  Shortage Management
-  Alternative Solution
-  Excess Inventory Management