



**THE DATASHEET OF  
1201M2S1CQE2**



# 1000 Series Miniature Slide Switches

## Features/Benefits

- Variety of actuators and terminations
- Panel mount tabs available
- Epoxy terminal seal—compatible with bottom-wash cleaning
- RoHS compliant

## Typical Applications

- Test & measurement equipment
- Telecommunications
- Computer & peripherals

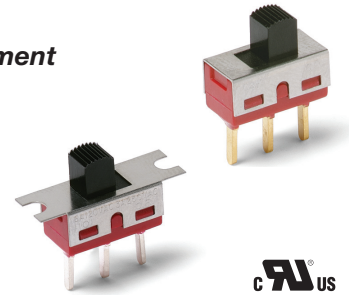

Models Available

## Specifications

CONTACT RATING: B contact material: 0.4 VA max. @ 20 V AC or DC max. Q contact material: 6 AMPS @ 120 V AC or 28 V DC, 3 AMPS @ 250 V AC. See page I-16 for additional ratings.

ELECTRICAL LIFE: 100,000 make-and-break cycles at full load on models with B, K or P contact material; 40,000 cycles on models with G, Q, L, M, S or R contact material.

CONTACT RESISTANCE: Below 10 m Ω typ. initial @ 2-4 V DC, 100 mA, for both silver and gold plated contacts.

INSULATION RESISTANCE: 10<sup>9</sup> Ω min.

DIELECTRIC STRENGTH: 1,000 Vrms min. @ sea level.

OPERATING TEMPERATURE: -30°C to 65°C

SOLDERABILITY: Per MIL-STD-202F method 208D, or EIA RS-186E method 9 (1 hour steam aging).

## Materials

CASE: diallyl phthalate (DAP), (UL 94V-0).

ACTUATOR: Nylon, black, standard.

HOUSING: Stainless steel.

SWITCH SUPPORT: Brass or steel, matte-tin plated.

END CONTACTS: B contact material: Copper alloy, with gold plate over nickel plate. Q contact material: Coin silver, silver plated. See page I-16 for additional contact materials.

CENTER CONTACT & ALL TERMINALS: B contact material: Copper alloy, with gold plate over nickel plate. Q contact material: Copper alloy, silver plated. See page I-16 for additional contact materials.

TERMINAL SEAL: Epoxy. Refer to Soldering and Cleaning in Technical Data chapter

**NOTE:** Any models supplied with Q, B, G, P, S or R contact material are RoHS compliant.

**NOTE:** Specifications and materials listed above are for switches with standard options.

For information on specific and custom switches, consult Customer Service Center.

## Build-A-Switch

To order, simply select desired option from each category and place in the appropriate box. Available options are shown and described on pages I-12 through I-16. For additional options not shown in catalog, consult Customer Service Center. All models have epoxy terminal seal and are compatible with all “bottom-wash” PCB cleaning methods.

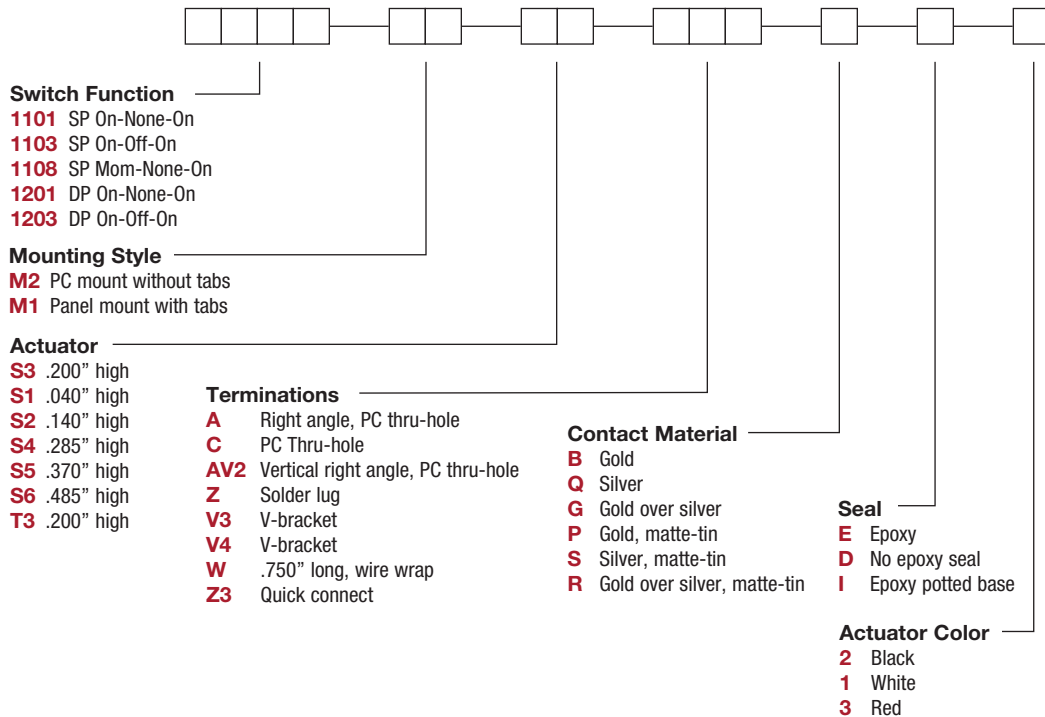

# 1000 Series Miniature Slide Switches

## SWITCH FUNCTION



NO. POLES	MODEL NO.	SWITCH FUNCTION			CONNECTED TERMINALS			SCHEMATIC
		POS. 1	POS. 2	POS. 3	POS. 1	POS. 2	POS. 3	
SP	1101	ON	NONE	ON	1-2	N/A	2-3	
	1103	ON	OFF	ON		OPEN		
	1108	MOM.	NONE	ON		N/A		
<p><b>SPDT</b></p> <p>Part number shown: 1101M2S3CQE2</p>								
DP	1201	ON	NONE	ON	2-1,5-4	OPEN	2-3,5-6	
	1203	ON	OFF	ON				
<p><b>DPDT</b></p> <p>Part number shown: 1201M2S3CQE2</p> <p>Terminal Nos. For Reference Only</p>								

MOM. = Momentary

All models with all options when ordered with G, Q, S or R contact material.

## MOUNTING STYLE



### M2 PC MOUNTING WITHOUT TABS

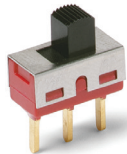

### M1 PANEL MOUNTING WITH TABS

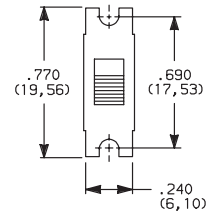
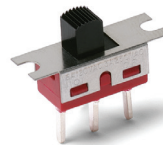

**NOTE:** Available with A, AV2, C, V3, V4, W terminations only.

**NOTE:** Available with C, W, Z, Z3 terminations only. No mounting hardware supplied.

### PANEL MOUNTING

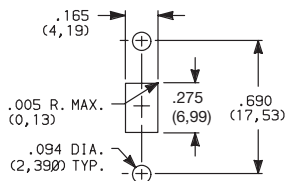

All actuators except T3.  
Single pole

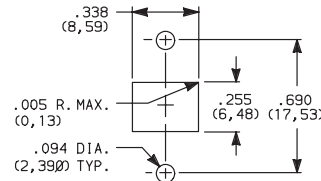

For T3 actuator only.  
Double pole



Third Angle  
Projection



19 dec 18

Dimensions are shown: Inch (mm)  
Specifications and dimensions subject to change

Slide

# 1000 Series Miniature Slide Switches

## ACTUATOR

ACTUATOR COLOR



**S3** .200" HIGH

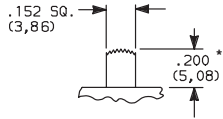

**S2** .140" HIGH

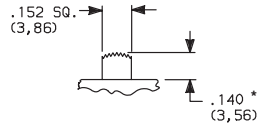

110X models only.

**S1** .040" HIGH

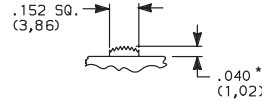

120X models only.

**S4** .285" HIGH

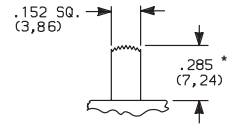

**S5** .370" HIGH

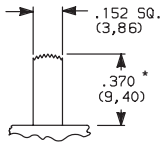

**S6** .485" HIGH

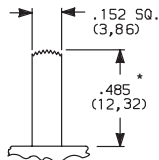

**T3** .200" HIGH

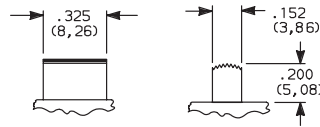

120X models only.

OPTION CODE	ACTUATOR COLOR
<b>2</b>	BLACK
<b>1</b>	WHITE
<b>3</b>	RED
<b>7</b>	BLUE
<b>9</b>	GRAY

Other colors available, consult Customer Service Center.

\* Subtract .014 (0,36) from actuator height, all models with A, AV2 - 2 pole, V3, V4 terminations.

Slide

## TERMINATIONS



**Z** SOLDER LUG

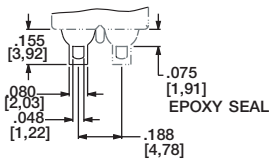

Not available with P, S or R contact materials.

**C** PC THRU-HOLE

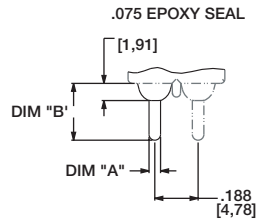

OPTION	DIM "A"	DIM "B"
C	.050 [0,76]	.250 [6,35]

PC MOUNTING

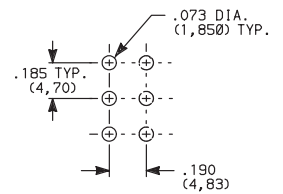

**SPDT & DPDT**

**Z3** QUICK CONNECT

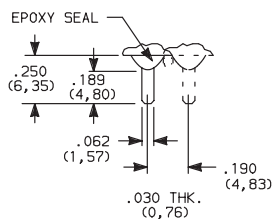

Not available with P, S or R contact materials. Mating quick connector available; order part number 530100000, page I-16.

**SPDT & DPDT**

**W** WIRE WRAP

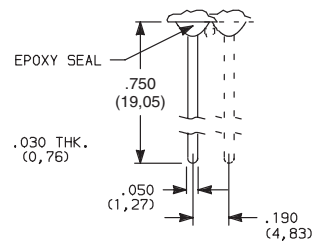

**SPDT & DPDT**



Dimensions are shown: Inches (mm)  
Specifications and dimensions subject to change



# 1000 Series Miniature Slide Switches

## TERMINATIONS

### A RIGHT ANGLE, PC THRU-HOLE

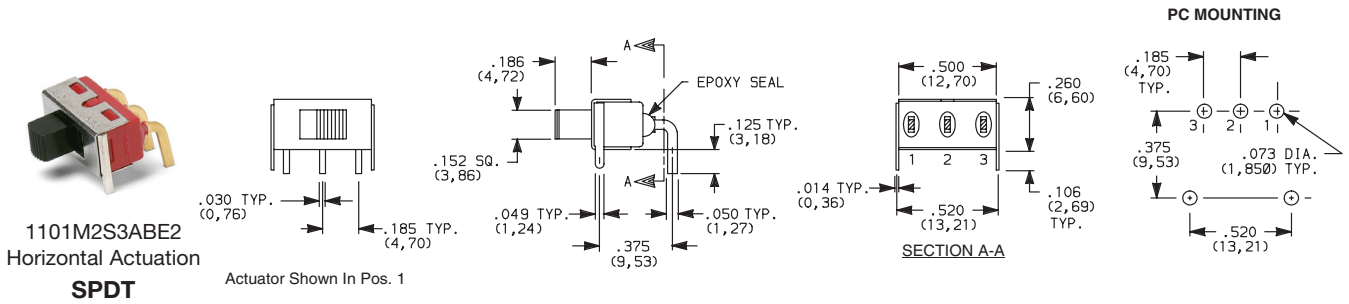

### A RIGHT ANGLE, PC THRU-HOLE

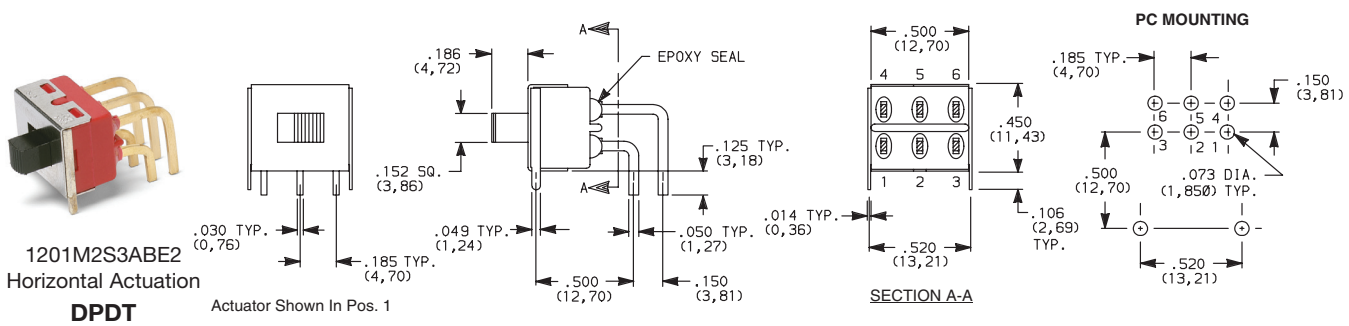

### AV2 VERTICAL RIGHT ANGLE, PC THRU-HOLE, .150" PITCH

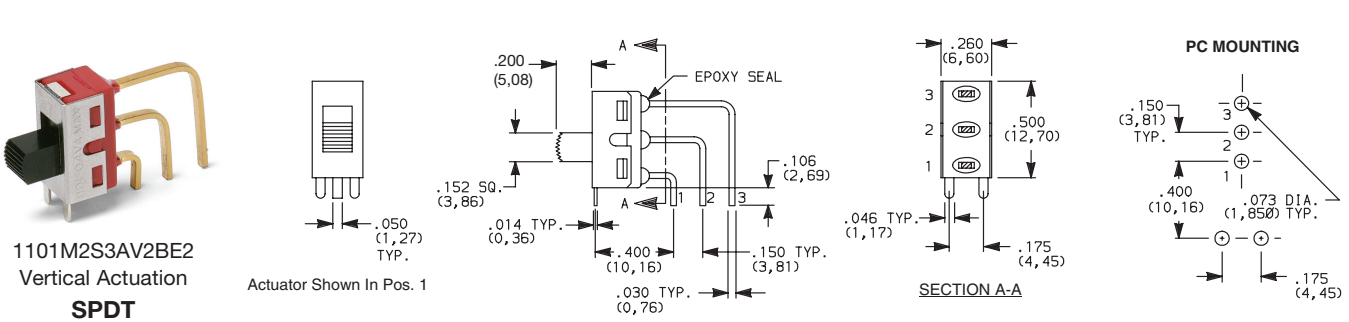

Dimensions are shown: Inch (mm)  
Specifications and dimensions subject to change



19 dec 18

# 1000 Series Miniature Slide Switches

## TERMINATIONS

**AV2** VERTICAL RIGHT ANGLE, PC THRU-HOLE,  
.150" PITCH

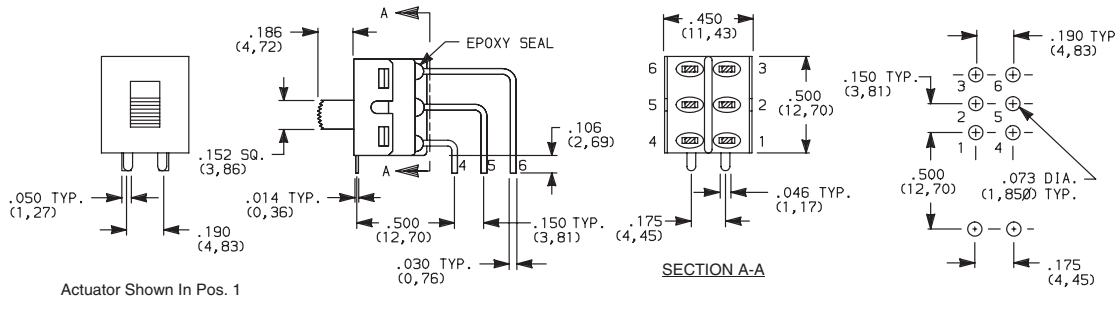

Not available with M1 mounting style, I seal option.  
Terminal bend radii and lead-in manufacturing option.

**V3, V4** VERTICAL MOUNT,  
V-BRACKET

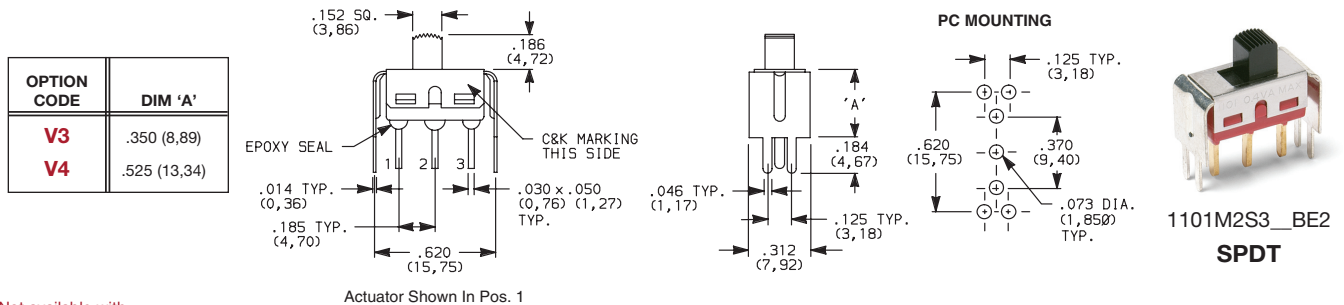

Not available with  
M1 mounting style and I seal.

**V3, V4** VERTICAL MOUNT,  
V-BRACKET

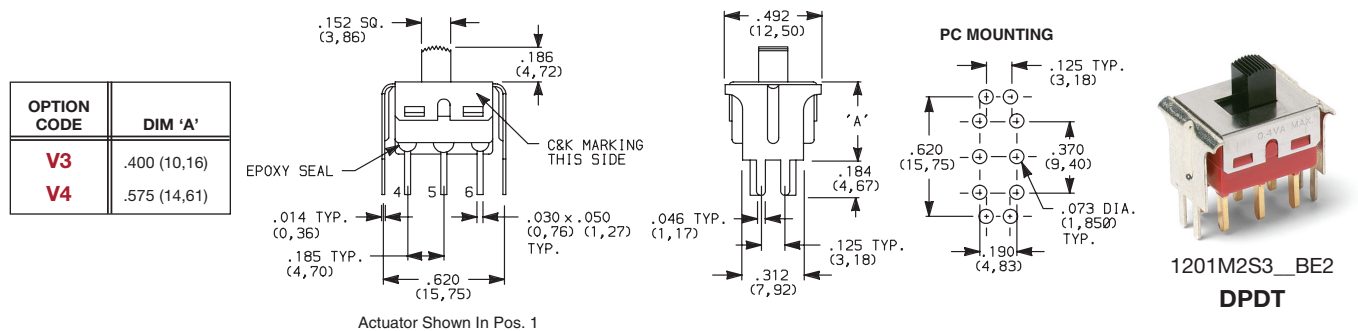

Not available with  
M1 mounting style and I seal.



Dimensions are shown: Inches (mm)  
Specifications and dimensions subject to change

# 1000 Series Miniature Slide Switches

## CONTACT MATERIAL

OPTION CODE	CONTACT MATERIAL	TERMINAL PLATING	RATINGS	
<b>B</b>	GOLD <sup>1</sup>	GOLD <sup>3</sup>	LOW LEVEL/ DRY CIRCUIT	0.4 VA MAX. @ 20 V AC OR DC MAX.
<b>P</b>		MATTE-TIN <sup>6</sup>		
<b>Q</b>	SILVER <sup>4,5</sup>	SILVER <sup>4</sup>	POWER	6 AMPS @ 120 V AC OR 28 V DC; 3 AMPS @ 250 V AC.
<b>S</b>		MATTE-TIN <sup>6</sup>		
<b>G</b>	GOLD OVER SILVER <sup>2,3</sup>	GOLD <sup>3</sup>	LOW LEVEL/DRY CIRCUIT OR POWER	0.4 VA MAX @ 20 V AC OR DC MAX OR 6 AMPS @ 120 V AC OR 0.4 MAX. 28 V DC; 3 AMPS @ 250 V AC.
<b>R</b>		MATTE-TIN <sup>6</sup>		

\* Note: See Technical Data section of this catalog for RoHS compliant and compatible definitions and specifications.

1 CONTACTS & TERMINALS: Copper alloy, with gold plate over nickel plate.

2 END CONTACTS: Coin silver, with gold plate over nickel plate.

3 CENTER CONTACTS & ALL TERMINALS: Copper alloy, with gold plate over nickel plate.

4 END CONTACTS: Coin silver, silver plated.

5 CENTER CONTACT & ALL TERMINALS: Copper alloy, silver plated.

6 TERMINALS: Copper alloy, with matte-tin over nickel plate.

All models **CRUS** with all options when ordered with G, Q, S or R contact material.

B contact material standard with all terminations except C, Z, Z3..

Q contact material standard with C, Z, Z3 terminations.

**P, S or R contact materials not available with Z, Z3 terminations.**

**NOTE:** Any models supplied with Q, B, G, P, S or R contact material are RoHS compliant.

## SEAL

**E** EPOXY SEAL

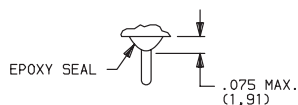

**D** NO EPOXY SEAL

**I** EPOXY POTTED BASE

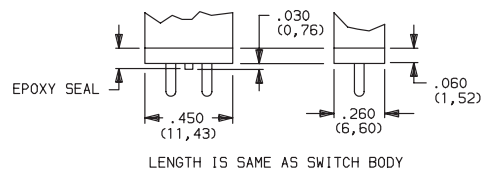

**NOTE:** Available with C, W, W3, Z, Z3 terminations only.

## AVAILABLE HARDWARE

Fits Z3 Termination  
female connector



PART NO.

**530100000**

Available in loose pieces.

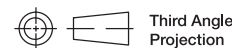



Third Angle  
Projection

Dimensions are shown: Inch (mm)

Specifications and dimensions subject to change

## Looking for pricing, stock, or lifecycle information?

Click below to explore more details on WIN SOURCE:

-  [View 1201M2S1CQE2 on WIN SOURCE](#)
-  [C&K Components Information](#)

## Optimize Your Supply Chain with WIN SOURCE Solutions

-  Global Sourcing Solution
-  Obsolete Management
-  Cost Control Management
-  Shortage Management
-  Alternative Solution
-  Excess Inventory Management