



# THE DATASHEET OF BNX002-01



# Block Type EMIFIL® (LC Combined) Lead Type

## BNX00\* Series

### ■ Dimensions

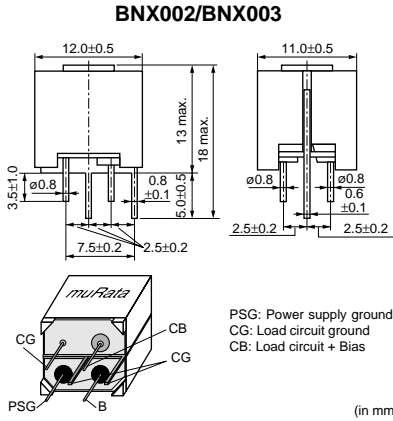

### ■ Dimensions

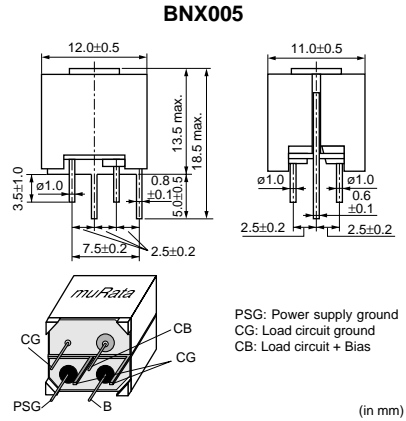

### ■ Insertion Loss Characteristics (Main Items)

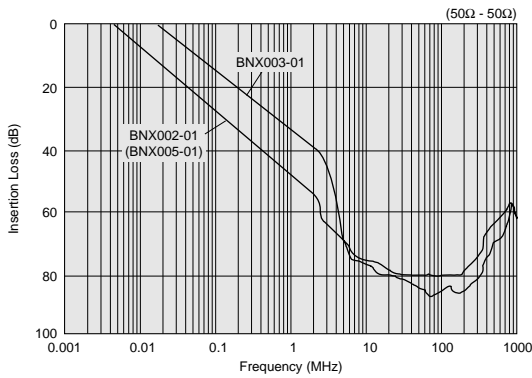

### ■ Equivalent Circuit

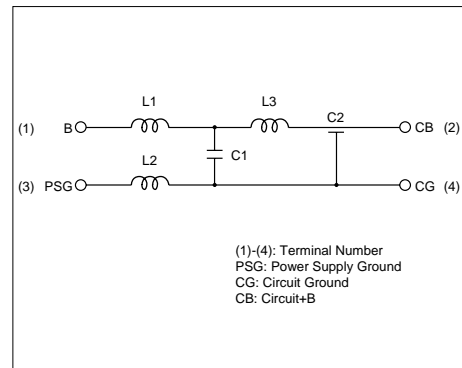

### ■ Packaging

Code	Packaging	Minimum Quantity
-	Box	100

### ■ Rated Value

Part Number	Rated Voltage	Withstand Voltage	Rated Current	Insulation Resistance(min.)	Insertion Loss
<b>BNX002-01</b>	50Vdc	125Vdc	10A	100M ohm	1MHz to 1GHz:40dB min. (20 to 25 degrees C line impedance=50 ohm)
<b>BNX003-01</b>	150Vdc	375Vdc	10A	100M ohm	5MHz to 1GHz:40dB min. (20 to 25 degrees C line impedance=50 ohm)
<b>BNX005-01</b>	50Vdc	125Vdc	15A	100M ohm	1MHz to 1GHz:40dB min. (20 to 25 degrees C line impedance=50 ohm)

Operating Temperature Range: -30°C to +85°C

Continued on the following page.

● This data sheet is applied for Block Type EMIFIL® used for General Electronics equipment for your design.

### ⚠ Note:

1. This datasheet is downloaded from the website of Murata Manufacturing co., ltd. Therefore, it's specifications are subject to change or our products in it may be discontinued without advance notice. Please check with our sales representatives or product engineers before ordering.
2. This datasheet has only typical specifications because there is no space for detailed specifications. Therefore, please approve our product specifications or transact the approval sheet for product specifications before ordering.

 Continued from the preceding page.

■  **Caution (Rating)**

Do not use products beyond the rated current and rated voltage as this may create excessive heat and deteriorate the insulation resistance.



● This data sheet is applied for Block Type EMIFIL® used for General Electronics equipment for your design.

 **Note:**







1. This datasheet is downloaded from the website of Murata Manufacturing co., Ltd. Therefore, it's specifications are subject to change or our products in it may be discontinued without advance notice. Please check with our sales representatives or product engineers before ordering.
2. This datasheet has only typical specifications because there is no space for detailed specifications. Therefore, please approve our product specifications or transact the approval sheet for product specifications before ordering.

## Looking for pricing, stock, or lifecycle information?

Click below to explore more details on WIN SOURCE:

-  [View BNX002-01 on WIN SOURCE](#)
-  [Murata Electronics North America Information](#)

## Optimize Your Supply Chain with WIN SOURCE Solutions

-  Global Sourcing Solution
-  Obsolete Management
-  Cost Control Management
-  Shortage Management
-  Alternative Solution
-  Excess Inventory Management