



**THE DATASHEET OF
110380-HMC452QS16G**





Typical Applications

The HMC452QS16G / HMC452QS16GE is ideal for applications requiring a high dynamic range amplifier:

- GSM, GPRS & EDGE
- CDMA & W-CDMA
- CATV/Cable Modem
- Fixed Wireless & WLL

Features

- Output IP3: +48 dBm
- 22.5 dB Gain @ 400 MHz
- 9 dB Gain @ 2100 MHz
- 53% PAE @ +31 dBm Pout
- +24 dBm CDMA2000 Channel Power @ -45 dBc ACP
- Single +5V Supply
- Integrated Power Control (VPD)
- QSOP16G SMT Package: 29.4 mm²

Functional Diagram

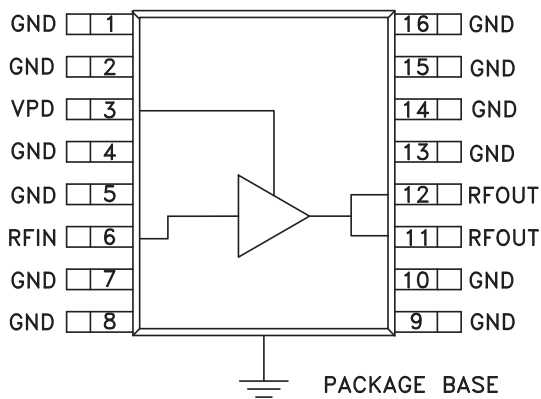

General Description

The HMC452QS16G & HMC452QS16GE are high dynamic range GaAs InGaP Heterojunction Bipolar Transistor (HBT) 1 watt MMIC power amplifiers operating between 0.4 and 2.2 GHz. Packaged in a miniature 16 lead QSOP plastic package, the amplifier gain is typically 22.5 dB at 0.4 GHz and 9 dB at 2.1 GHz. Utilizing a minimum number of external components and a single +5V supply, the amplifier output IP3 can be optimized to +43 dBm at 0.4 GHz or +48 dBm at 2.1 GHz. The power control (VPD) can be used for full power down or RF output power/current control. The high output IP3 and PAE make the HMC452QS16G(E) ideal power amplifiers for Cellular/PCS/3G, WLL, ISM and Fixed Wireless applications.

Electrical Specifications, $T_A = +25^\circ\text{C}$, $V_S = +5\text{V}$, $VPD = +5\text{V}$ [1]

| Parameter | Min. | Typ. | Max. | Min. | Typ. | Max. | Min. | Typ. | Max. | Min. | Typ. | Max. | Min. | Typ. | Max. | Units |
|---|-----------|-------|------|-----------|-------|------|-----------|-------|------|-------------|-------|------|-------------|-------|------|-------|
| Frequency Range | 400 - 410 | | | 450 - 496 | | | 810 - 960 | | | 1710 - 1990 | | | 2010 - 2170 | | | MHz |
| Gain | 20 | 22.5 | | 19 | 21.5 | | 13 | 15.5 | | 7.5 | 10 | | 6.5 | 9 | | dB |
| Gain Variation Over Temperature | | 0.012 | 0.02 | | 0.012 | 0.02 | | 0.012 | 0.02 | | 0.012 | 0.02 | | 0.012 | 0.02 | dB/C |
| Input Return Loss | | 13 | | | 15 | | | 9 | | | 17 | | | 11 | | dB |
| Output Return Loss | | 7 | | | 8 | | | 12 | | | 15 | | | 20 | | dB |
| Output Power for 1dB Compression (P1dB) | 27.5 | 30.5 | | 27.5 | 30.5 | | 27 | 30 | | 28 | 31 | | 28 | 31 | | dBm |
| Saturated Output Power (Psat) | | 31 | | | 31 | | | 31 | | | 31.5 | | | 32.5 | | dBm |
| Output Third Order Intercept (IP3) [2] | 40 | 43 | | 41 | 44 | | 45 | 48 | | 45 | 48 | | 45 | 48 | | dBm |
| Noise Figure | | 7 | | | 7 | | | 7 | | | 7 | | | 7.5 | | dB |
| Supply Current (Icq) | | 485 | | | 485 | | | 485 | | | 485 | | | 485 | | mA |
| Control Current (IPD) | | 10 | | | 10 | | | 10 | | | 10 | | | 10 | | mA |

[1] Specifications and data reflect HMC452QS16G measured using the respective application circuits for each designated frequency band found herein. Contact the HMC Applications Group for assistance in optimizing performance for your application.

[2] Two-tone input power of -10 dBm per tone, 1 MHz spacing.



InGaP HBT 1 WATT POWER AMPLIFIER, 0.4 - 2.2 GHz

Broadband Gain & Return Loss @ 400 MHz

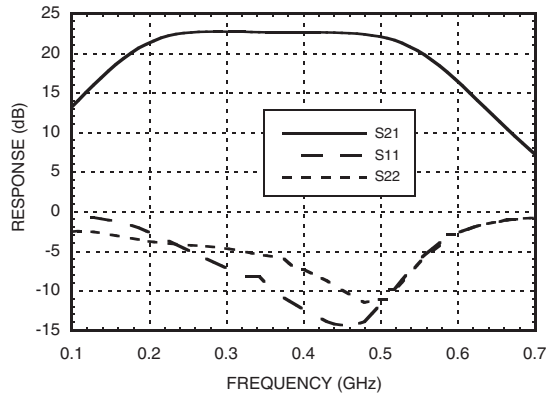

Gain vs. Temperature @ 400 MHz

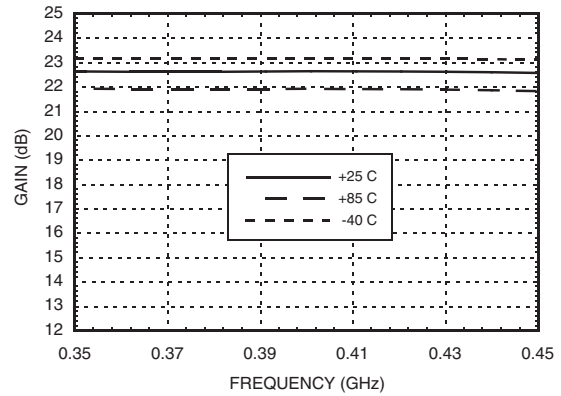

Input Return Loss vs. Temperature @ 400 MHz

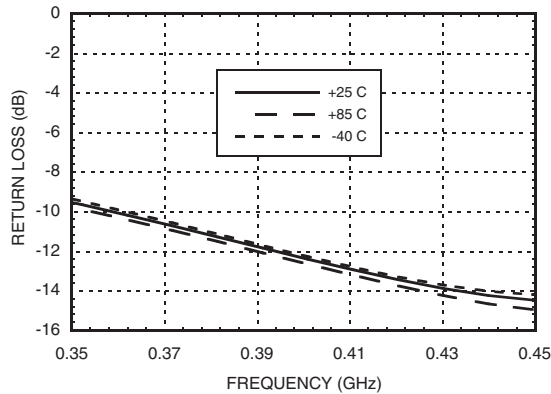

Output Return Loss vs. Temperature @ 400 MHz

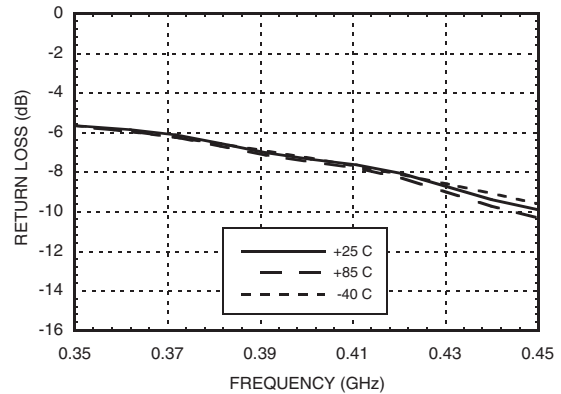

P1dB vs. Temperature @ 400 MHz

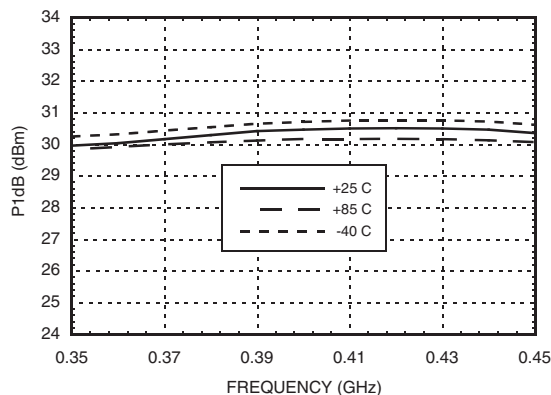

Psat vs. Temperature @ 400 MHz

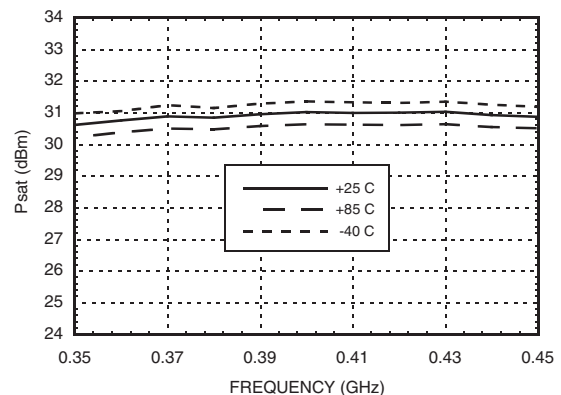

Information furnished by Analog Devices is believed to be accurate and reliable. However, no responsibility is assumed by Analog Devices for its use, nor for any infringements of patents or other rights of third parties that may result from its use. Specifications subject to change without notice. No license is granted by implication or otherwise under any patent or patent rights of Analog Devices. Trademarks and registered trademarks are the property of their respective owners.

For price, delivery, and to place orders: Analog Devices, Inc., One Technology Way, P.O. Box 9106, Norwood, MA 02062-9106 Phone: 781-329-4700 • Order online at www.analog.com Application Support: Phone: 1-800-ANALOG-D



InGaP HBT 1 WATT POWER AMPLIFIER, 0.4 - 2.2 GHz

Output IP3 vs. Temperature @ 400 MHz

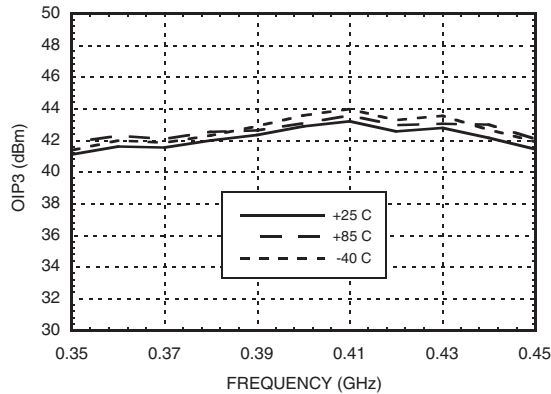

Noise Figure vs. Temperature @ 400 MHz

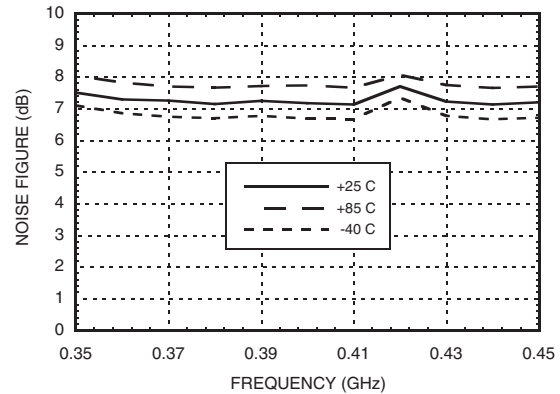

Reverse Isolation vs. Temperature @ 400 MHz

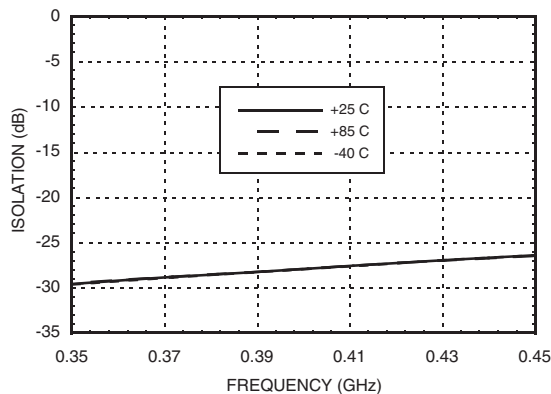

Gain, Power & IP3 vs. Supply Voltage @ 400 MHz

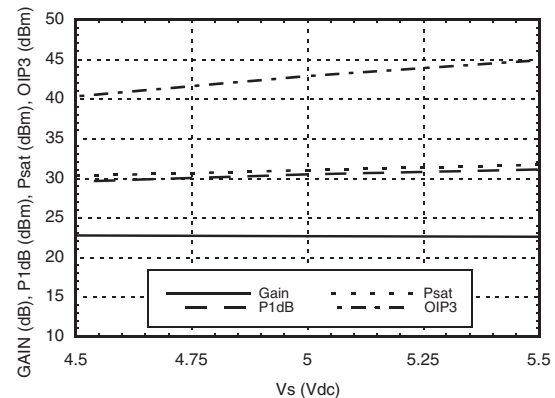

Power Compression @ 400 MHz

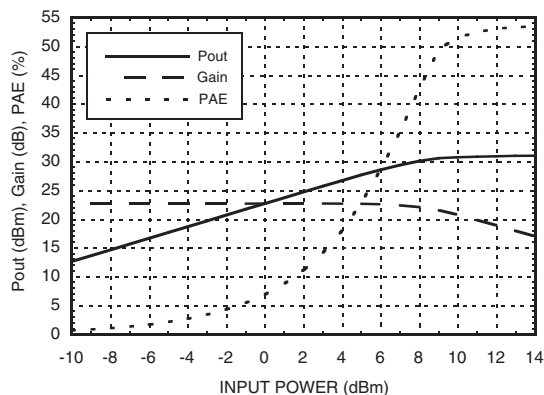

ACPR vs. Supply Voltage @ 400 MHz W-CDMA, 64 DPCH

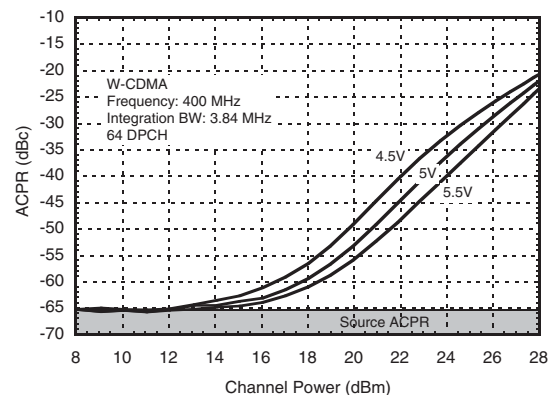

Information furnished by Analog Devices is believed to be accurate and reliable. However, no responsibility is assumed by Analog Devices for its use, nor for any infringements of patents or other rights of third parties that may result from its use. Specifications subject to change without notice. No license is granted by implication or otherwise under any patent or patent rights of Analog Devices. Trademarks and registered trademarks are the property of their respective owners.

For price, delivery, and to place orders: Analog Devices, Inc., One Technology Way, P.O. Box 9106, Norwood, MA 02062-9106 Phone: 781-329-4700 • Order online at www.analog.com Application Support: Phone: 1-800-ANALOG-D



**InGaP HBT 1 WATT POWER
AMPLIFIER, 0.4 - 2.2 GHz**

**Broadband Gain
& Return Loss @ 470 MHz**

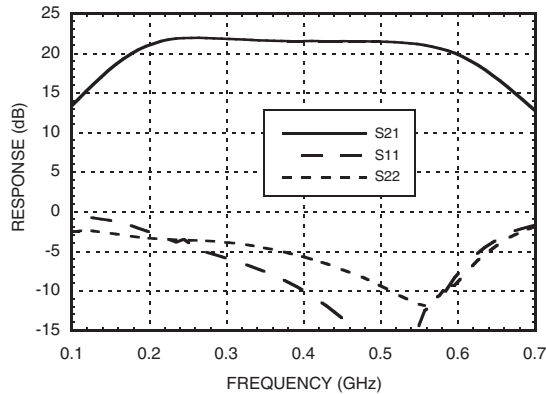

Gain vs. Temperature @ 470 MHz

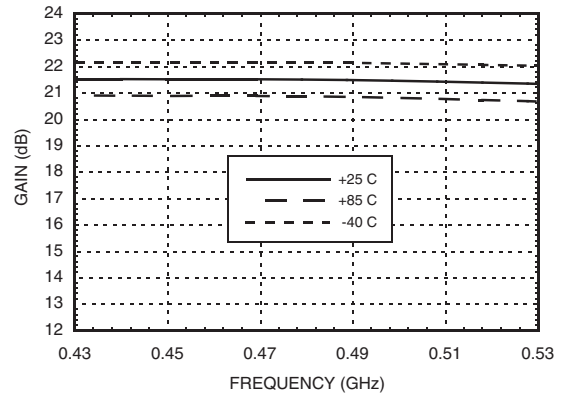

**Input Return Loss
vs. Temperature @ 470 MHz**

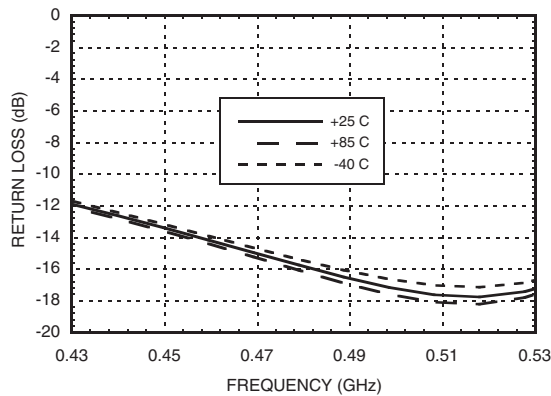

**Output Return Loss
vs. Temperature @ 470 MHz**

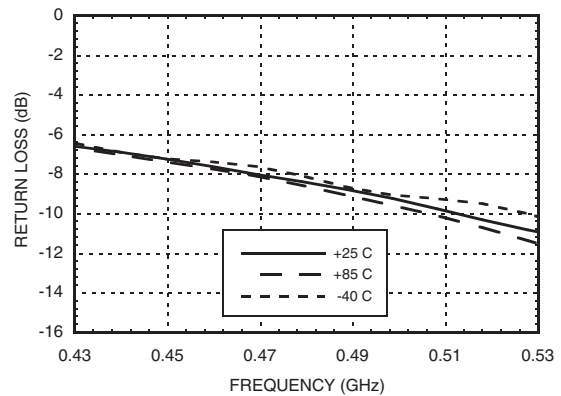

P1dB vs. Temperature @ 470 MHz

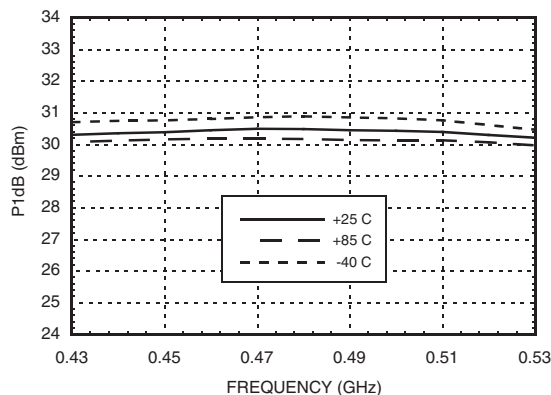

Psat vs. Temperature @ 470 MHz

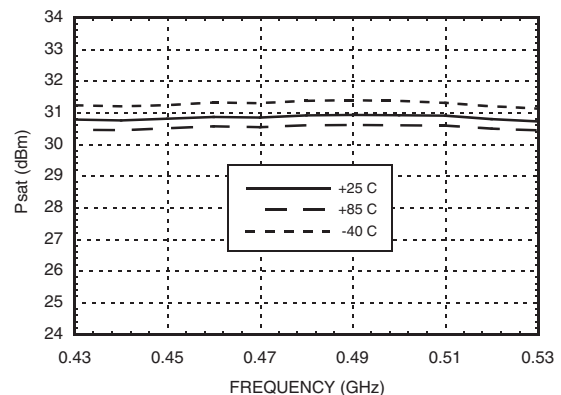

Information furnished by Analog Devices is believed to be accurate and reliable. However, no responsibility is assumed by Analog Devices for its use, nor for any infringements of patents or other rights of third parties that may result from its use. Specifications subject to change without notice. No license is granted by implication or otherwise under any patent or patent rights of Analog Devices. Trademarks and registered trademarks are the property of their respective owners.

For price, delivery, and to place orders: Analog Devices, Inc., One Technology Way, P.O. Box 9106, Norwood, MA 02062-9106 Phone: 781-329-4700 • Order online at www.analog.com Application Support: Phone: 1-800-ANALOG-D



InGaP HBT 1 WATT POWER AMPLIFIER, 0.4 - 2.2 GHz

Output IP3 vs. Temperature @ 470 MHz

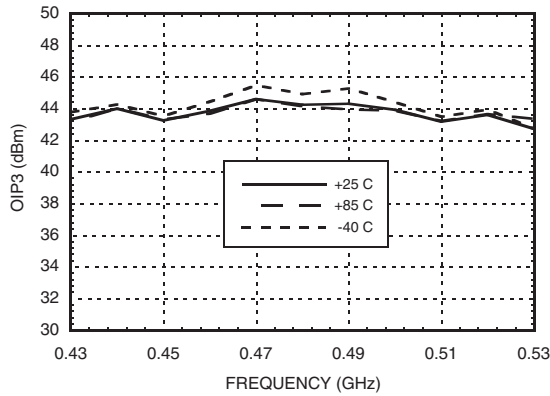

Noise Figure vs. Temperature @ 470 MHz

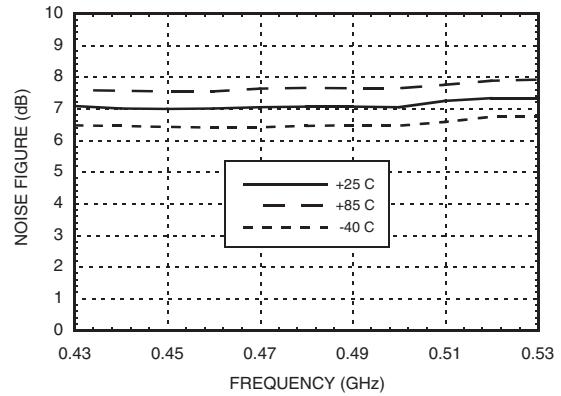

Reverse Isolation vs. Temperature @ 470 MHz

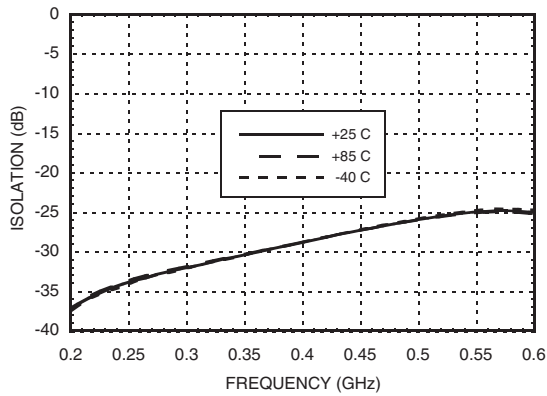

Gain, Power & IP3 vs. Supply Voltage @ 470 MHz

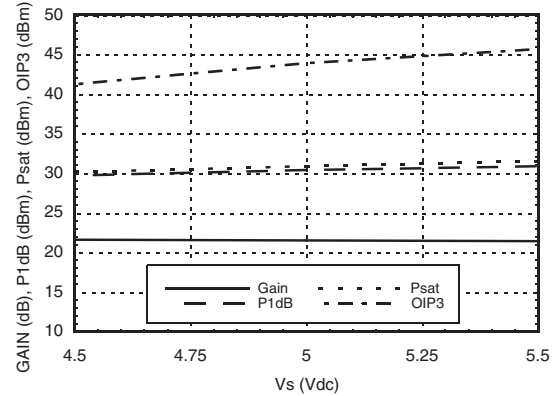

Power Compression @ 470 MHz

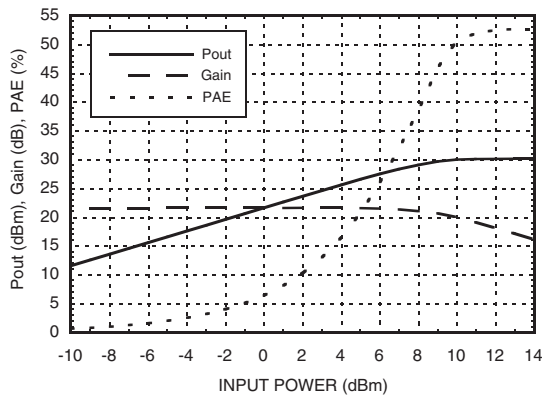

ACPR vs. Supply Voltage @ 470 MHz W-CDMA, 64 DPCH

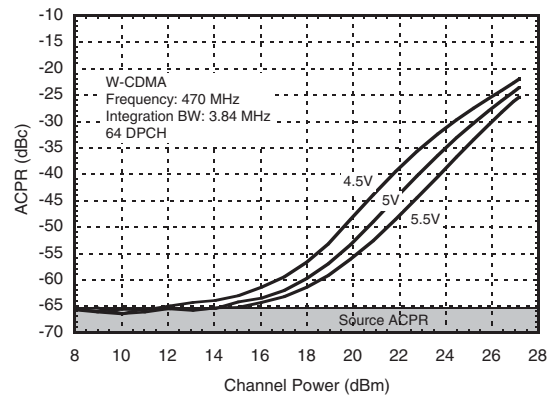



**InGaP HBT 1 WATT POWER
AMPLIFIER, 0.4 - 2.2 GHz**

**Broadband Gain
& Return Loss @ 900 MHz**

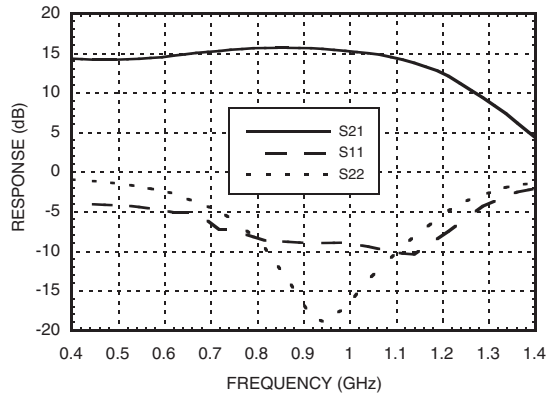

Gain vs. Temperature @ 900 MHz

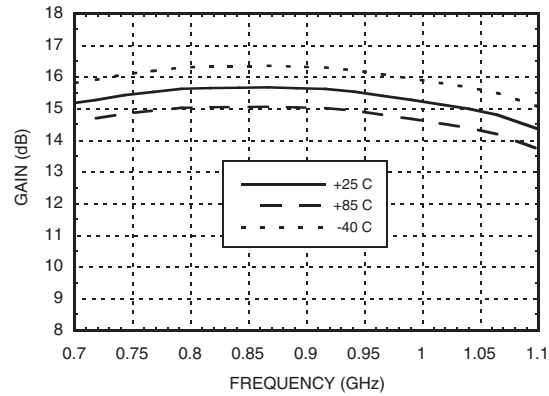

**Input Return Loss
vs. Temperature @ 900 MHz**

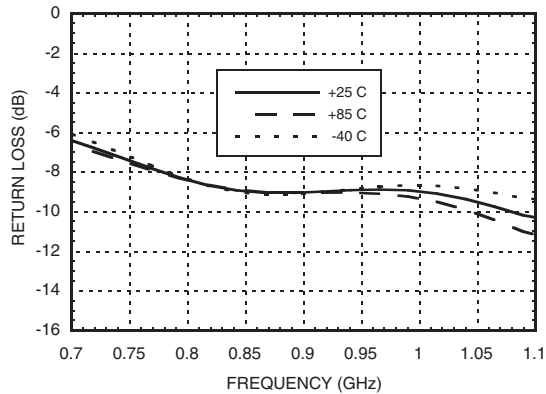

**Output Return Loss
vs. Temperature @ 900 MHz**

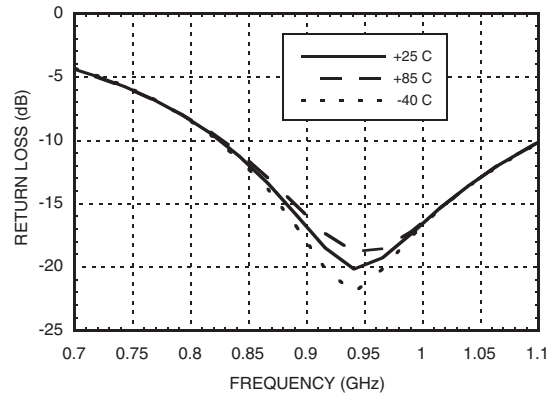

P1dB vs. Temperature @ 900 MHz

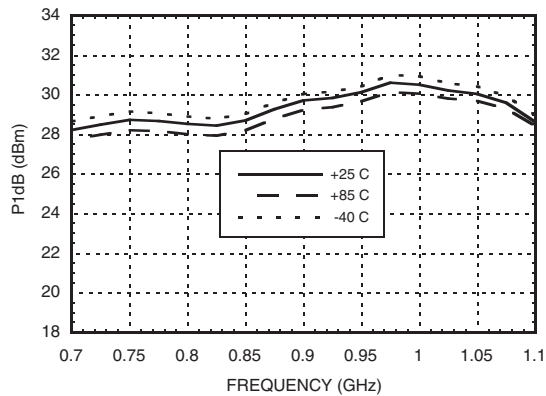

Psat vs. Temperature @ 900 MHz

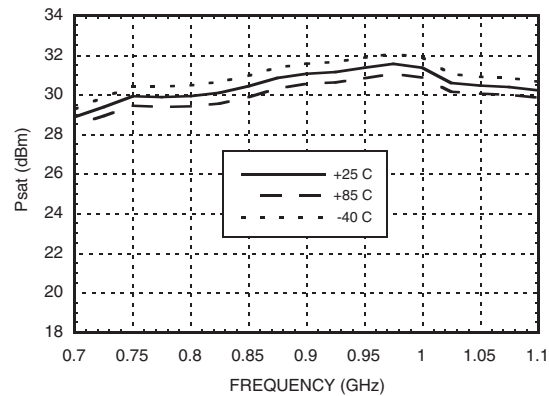

Information furnished by Analog Devices is believed to be accurate and reliable. However, no responsibility is assumed by Analog Devices for its use, nor for any infringements of patents or other rights of third parties that may result from its use. Specifications subject to change without notice. No license is granted by implication or otherwise under any patent or patent rights of Analog Devices. Trademarks and registered trademarks are the property of their respective owners.

For price, delivery, and to place orders: Analog Devices, Inc., One Technology Way, P.O. Box 9106, Norwood, MA 02062-9106 Phone: 781-329-4700 • Order online at www.analog.com Application Support: Phone: 1-800-ANALOG-D



**InGaP HBT 1 WATT POWER
AMPLIFIER, 0.4 - 2.2 GHz**

Output IP3 vs. Temperature @ 900 MHz

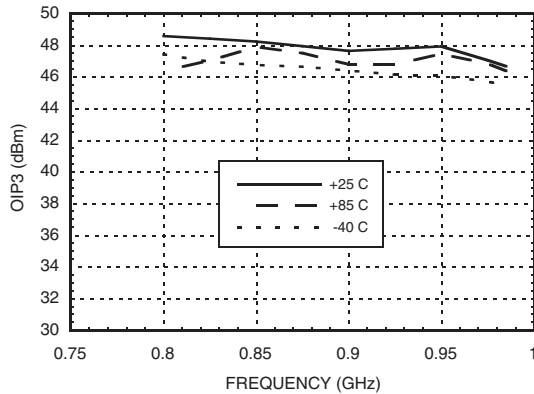

Noise Figure vs. Temperature @ 900 MHz

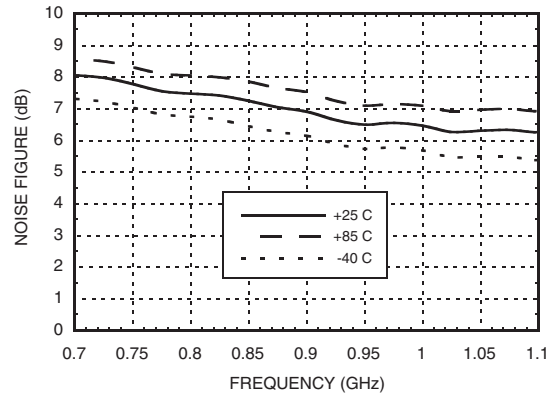

**Reverse Isolation
vs. Temperature @ 900 MHz**

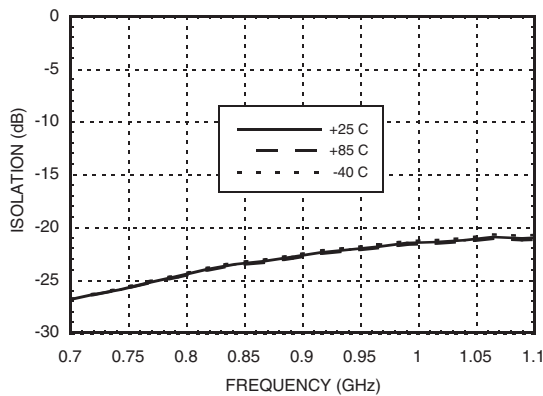

**Gain, Power & IP3
vs. Supply Voltage @ 900 MHz**

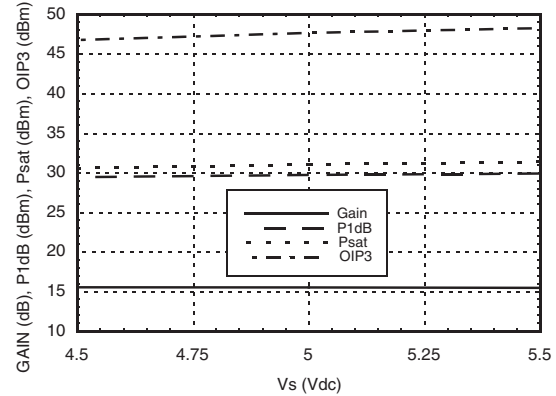

**Gain, Power & IP3
vs. Supply Current @ 900 MHz***

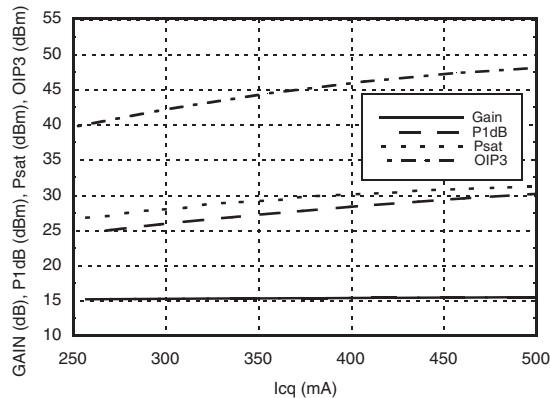

**ACPR vs. Supply Voltage @ 910 MHz
CDMA IS95, 9 Channels Forward**

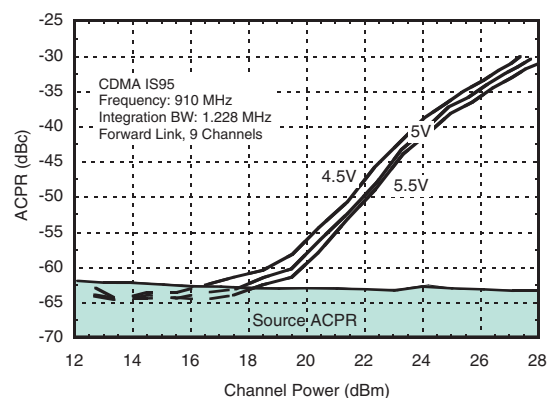

* Icq is controlled by varying VPD.

Information furnished by Analog Devices is believed to be accurate and reliable. However, no responsibility is assumed by Analog Devices for its use, nor for any infringements of patents or other rights of third parties that may result from its use. Specifications subject to change without notice. No license is granted by implication or otherwise under any patent or patent rights of Analog Devices. Trademarks and registered trademarks are the property of their respective owners.

For price, delivery, and to place orders: Analog Devices, Inc., One Technology Way, P.O. Box 9106, Norwood, MA 02062-9106 Phone: 781-329-4700 • Order online at www.analog.com Application Support: Phone: 1-800-ANALOG-D



InGaP HBT 1 WATT POWER AMPLIFIER, 0.4 - 2.2 GHz

Broadband Gain & Return Loss @ 1900 MHz

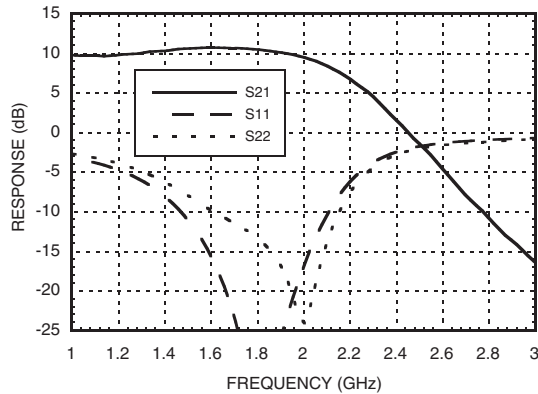

Gain vs. Temperature @ 1900 MHz

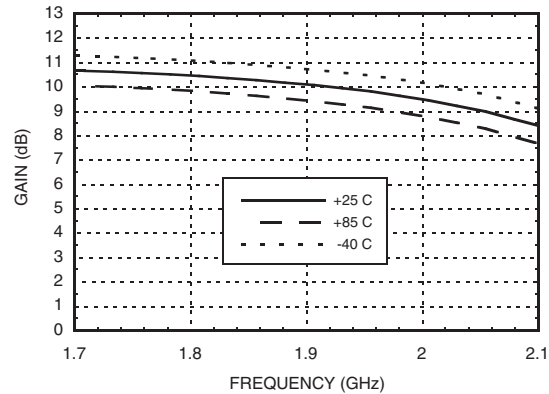

Input Return Loss vs. Temperature @ 1900 MHz

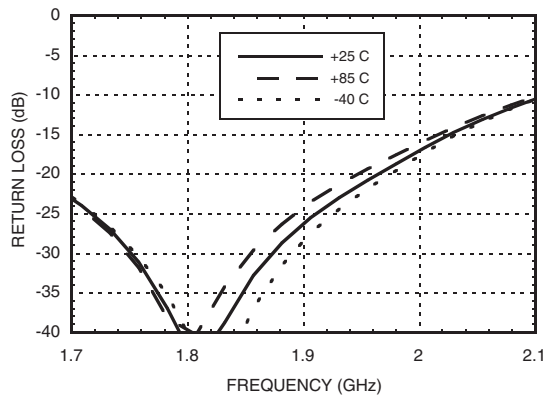

Output Return Loss vs. Temperature @ 1900 MHz

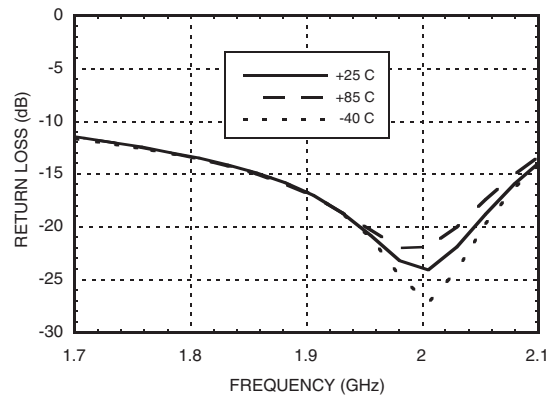

P1dB vs. Temperature @ 1900 MHz

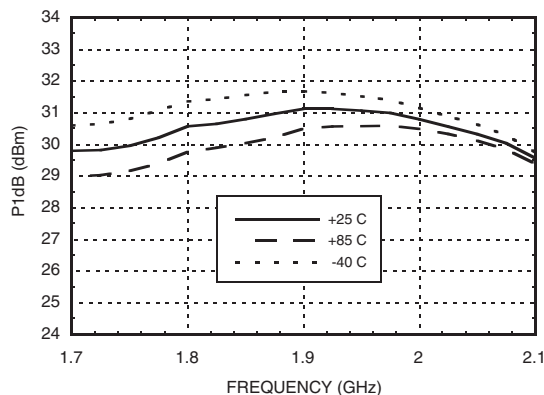

Psat vs. Temperature @ 1900 MHz

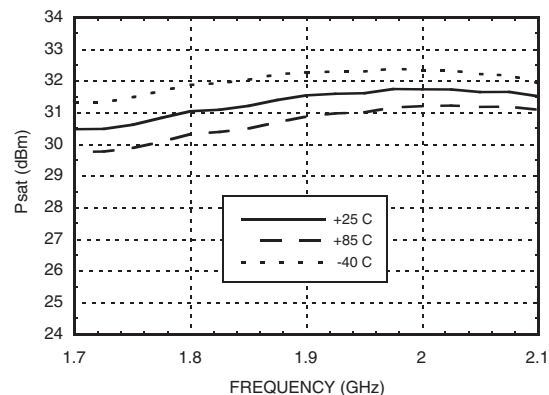

Information furnished by Analog Devices is believed to be accurate and reliable. However, no responsibility is assumed by Analog Devices for its use, nor for any infringements of patents or other rights of third parties that may result from its use. Specifications subject to change without notice. No license is granted by implication or otherwise under any patent or patent rights of Analog Devices. Trademarks and registered trademarks are the property of their respective owners.

For price, delivery, and to place orders: Analog Devices, Inc., One Technology Way, P.O. Box 9106, Norwood, MA 02062-9106 Phone: 781-329-4700 • Order online at www.analog.com Application Support: Phone: 1-800-ANALOG-D



InGaP HBT 1 WATT POWER AMPLIFIER, 0.4 - 2.2 GHz

Output IP3 vs. Temperature @ 1900 MHz

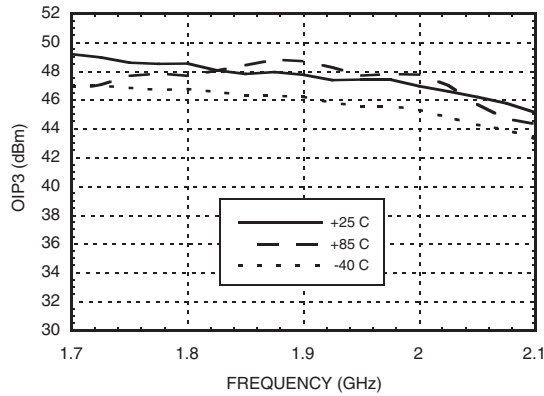

Noise Figure vs. Temperature @ 1900 MHz

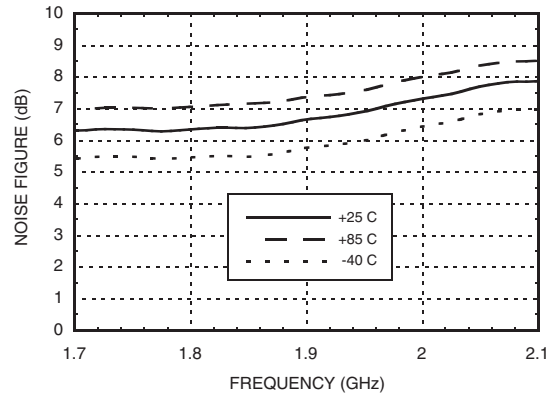

Reverse Isolation vs. Temperature @ 1900 MHz

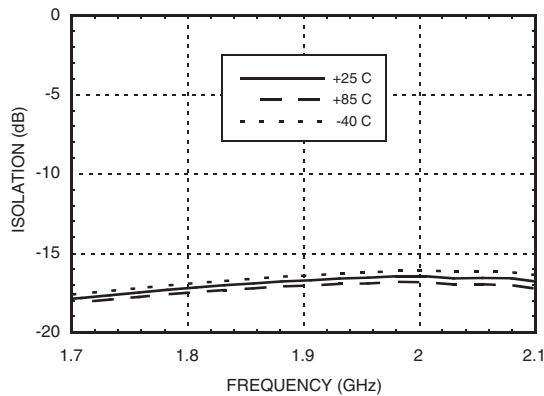

Gain, Power & IP3 vs. Supply Voltage @ 1900 MHz

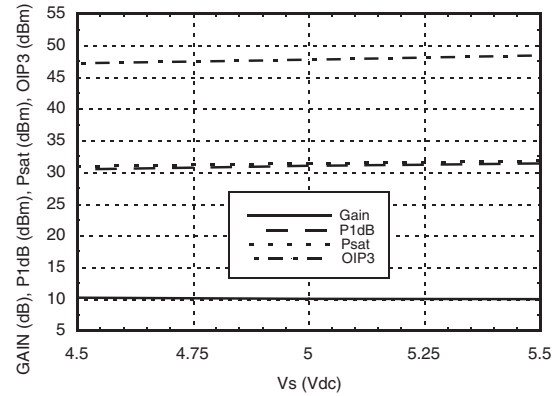

Gain, Power & IP3 vs. Supply Current @ 1900 MHz*

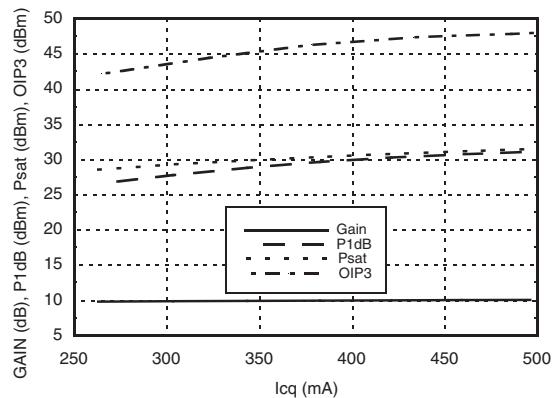

ACPR vs. Supply Voltage @ 1960 MHz CDMA 2000, 9 Channels Forward

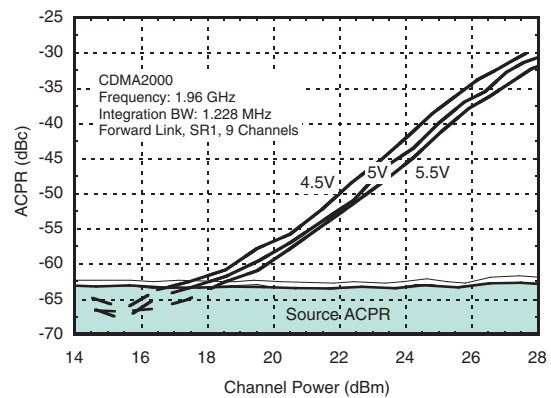

* Icq is controlled by varying VPD.

Information furnished by Analog Devices is believed to be accurate and reliable. However, no responsibility is assumed by Analog Devices for its use, nor for any infringements of patents or other rights of third parties that may result from its use. Specifications subject to change without notice. No license is granted by implication or otherwise under any patent or patent rights of Analog Devices. Trademarks and registered trademarks are the property of their respective owners.

For price, delivery, and to place orders: Analog Devices, Inc., One Technology Way, P.O. Box 9106, Norwood, MA 02062-9106 Phone: 781-329-4700 • Order online at www.analog.com Application Support: Phone: 1-800-ANALOG-D



InGaP HBT 1 WATT POWER AMPLIFIER, 0.4 - 2.2 GHz

Broadband Gain & Return Loss @ 2100 MHz

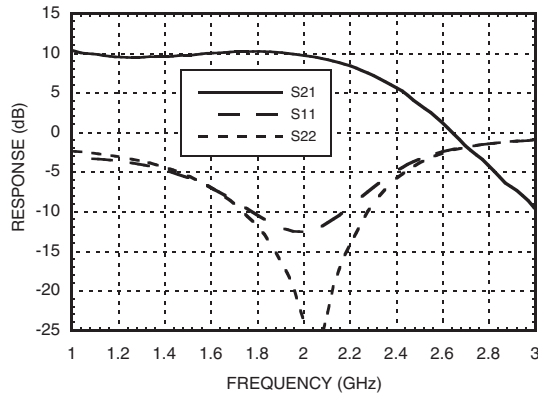

Gain vs. Temperature @ 2100 MHz

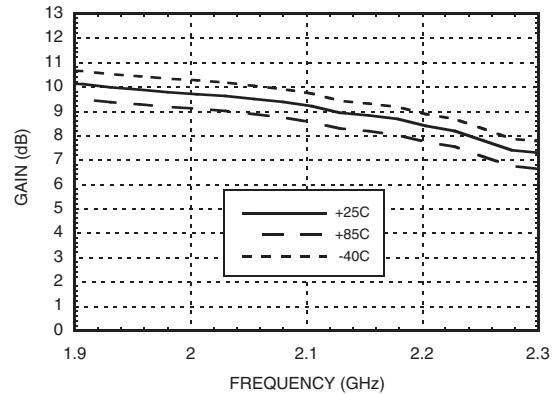

Input Return Loss vs. Temperature @ 2100 MHz

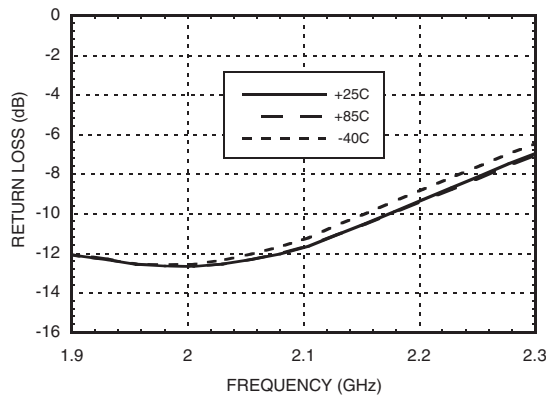

Output Return Loss vs. Temperature @ 2100 MHz

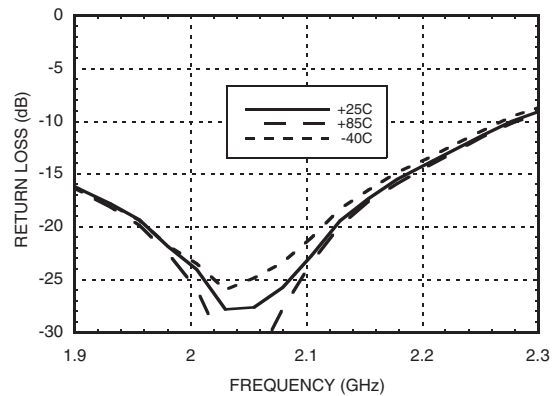

P1dB vs. Temperature @ 2100 MHz

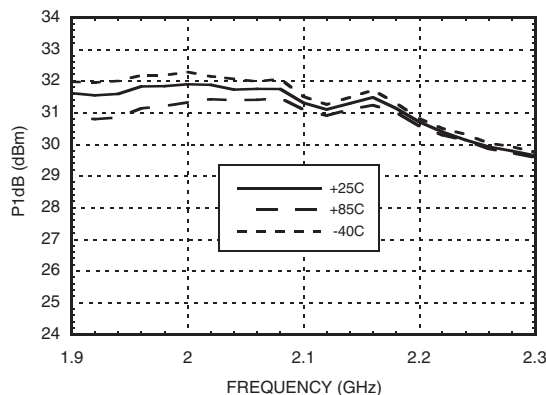

Psat vs. Temperature @ 2100 MHz

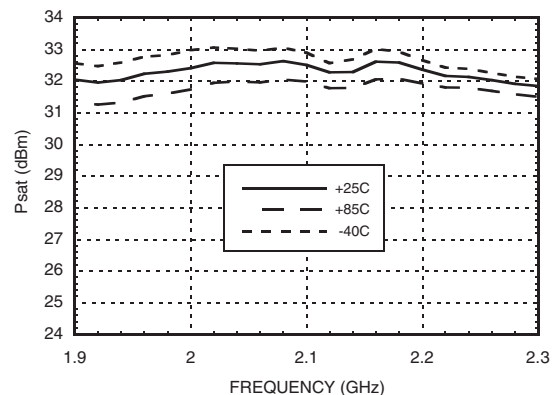

Information furnished by Analog Devices is believed to be accurate and reliable. However, no responsibility is assumed by Analog Devices for its use, nor for any infringements of patents or other rights of third parties that may result from its use. Specifications subject to change without notice. No license is granted by implication or otherwise under any patent or patent rights of Analog Devices. Trademarks and registered trademarks are the property of their respective owners.

For price, delivery, and to place orders: Analog Devices, Inc., One Technology Way, P.O. Box 9106, Norwood, MA 02062-9106 Phone: 781-329-4700 • Order online at www.analog.com Application Support: Phone: 1-800-ANALOG-D



InGaP HBT 1 WATT POWER AMPLIFIER, 0.4 - 2.2 GHz

Output IP3 vs. Temperature @ 2100 MHz

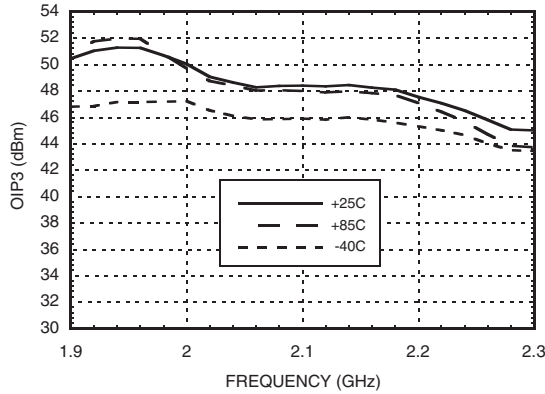

Noise Figure vs. Temperature @ 2100 MHz

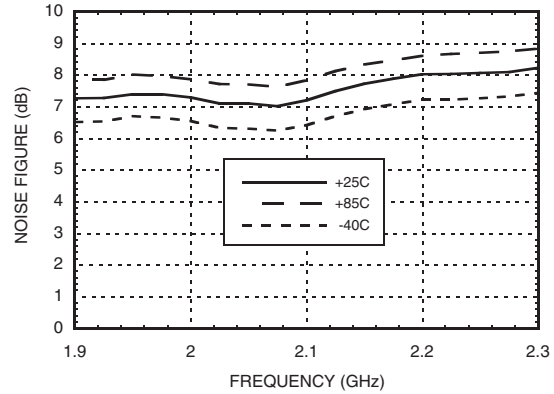

Reverse Isolation vs. Temperature @ 2100 MHz

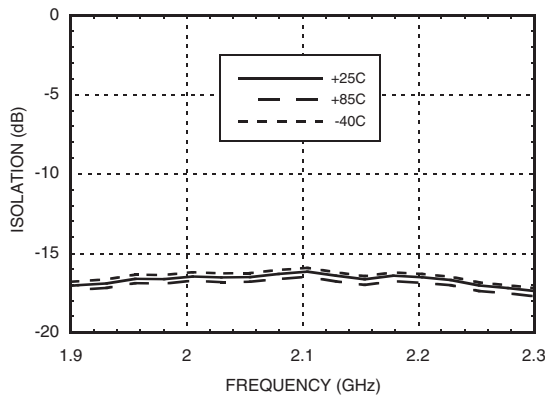

Gain, Power & IP3 vs. Supply Voltage @ 2100 MHz

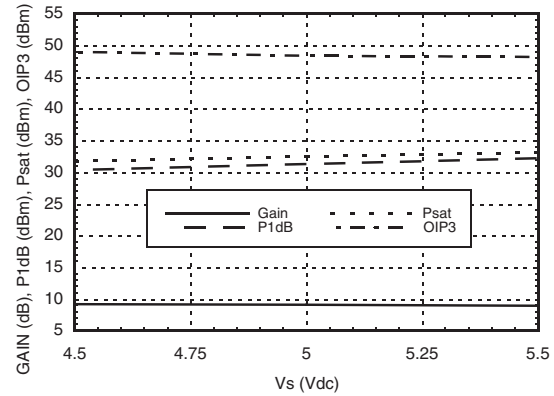

Power Compression @ 2100 MHz

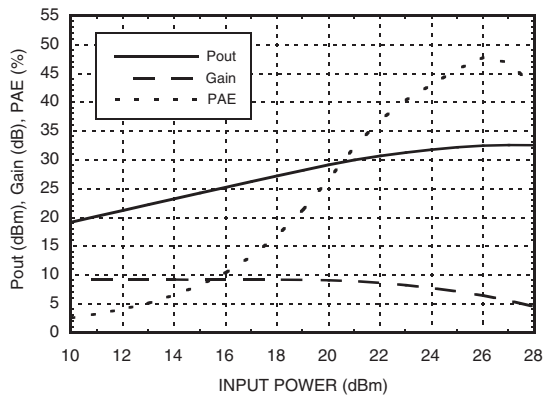

ACPR vs. Supply Voltage @ 2140 MHz W-CDMA, 64 DPCH

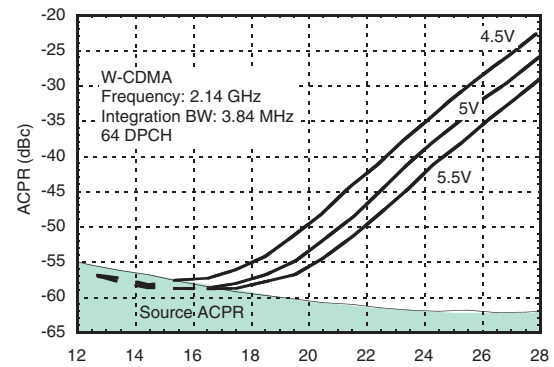

Information furnished by Analog Devices is believed to be accurate and reliable. However, no responsibility is assumed by Analog Devices for its use, nor for any infringements of patents or other rights of third parties that may result from its use. Specifications subject to change without notice. No license is granted by implication or otherwise under any patent or patent rights of Analog Devices. Trademarks and registered trademarks are the property of their respective owners.

For price, delivery, and to place orders: Analog Devices, Inc., One Technology Way, P.O. Box 9106, Norwood, MA 02062-9106 Phone: 781-329-4700 • Order online at www.analog.com Application Support: Phone: 1-800-ANALOG-D



Power Dissipation

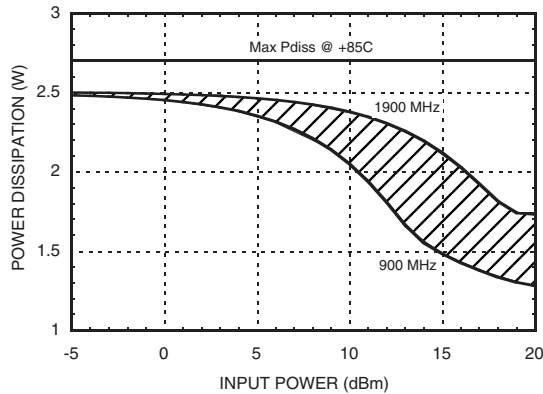

Absolute Maximum Ratings

| | |
|---|----------------|
| Collector Bias Voltage (Vcc) | +6.0 Vdc |
| Control Voltage (Vpd) | +5.3 Vdc |
| RF Input Power (RFIN)(Vs = Vpd = +5Vdc) | +31 dBm |
| Junction Temperature | 150 °C |
| Continuous Pdiss (T = 85 °C) (derate 41.5 mW/°C above 85 °C) | 2.7 W |
| Thermal Resistance (junction to ground paddle) | 24.1 °C/W |
| Storage Temperature | -65 to +150 °C |
| Operating Temperature | -40 to +85 °C |
| ESD Sensitivity (HBM) | Class 1A |

11



ELECTROSTATIC SENSITIVE DEVICE
OBSERVE HANDLING PRECAUTIONS

Outline Drawing

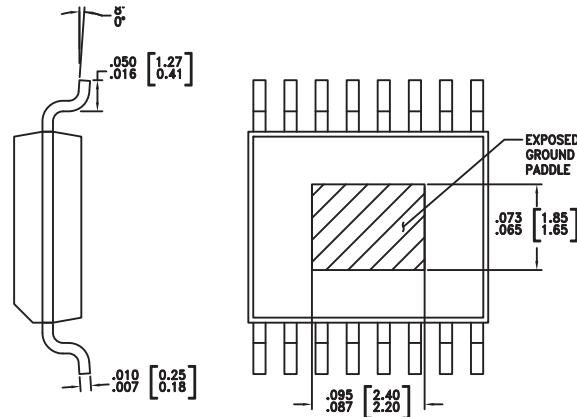
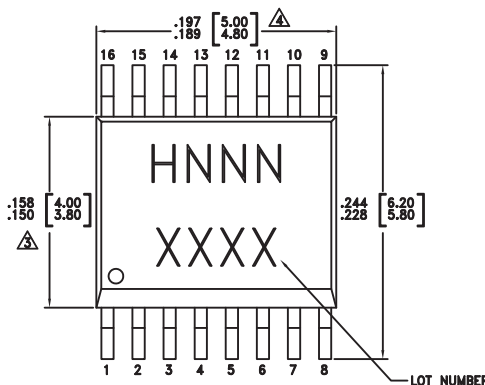

NOTES:

- LEADFRAME MATERIAL: COPPER ALLOY
- DIMENSIONS ARE IN INCHES [MILLIMETERS]
- DIMENSION DOES NOT INCLUDE MOLDFLASH OF 0.15mm PER SIDE.
- DIMENSION DOES NOT INCLUDE MOLDFLASH OF 0.25mm PER SIDE.
- ALL GROUND LEADS AND GROUND PADDLE MUST BE SOLDERED TO PCB RF GROUND.

Package Information

| Part Number | Package Body Material | Lead Finish | MSL Rating | Package Marking ^[3] |
|--------------|--|---------------|---------------------|--------------------------------|
| HMC452QS16G | Low Stress Injection Molded Plastic | Sn/Pb Solder | MSL1 ^[1] | H452 XXXX |
| HMC452QS16GE | RoHS-compliant Low Stress Injection Molded Plastic | 100% matte Sn | MSL1 ^[2] | <u>H452</u> XXXX |

[1] Max peak reflow temperature of 235 °C

[2] Max peak reflow temperature of 260 °C

[3] 4-Digit lot number XXXX

Information furnished by Analog Devices is believed to be accurate and reliable. However, no responsibility is assumed by Analog Devices for its use, nor for any infringements of patents or other rights of third parties that may result from its use. Specifications subject to change without notice. No license is granted by implication or otherwise under any patent or patent rights of Analog Devices. Trademarks and registered trademarks are the property of their respective owners.

For price, delivery, and to place orders: Analog Devices, Inc., One Technology Way, P.O. Box 9106, Norwood, MA 02062-9106 Phone: 781-329-4700 • Order online at www.analog.com Application Support: Phone: 1-800-ANALOG-D



Pin Descriptions

| Pin Number | Function | Description | Interface Schematic |
|-------------------------|----------|---|---------------------|
| 1, 2, 4, 5, 7-10, 13-16 | GND | These pins & package bottom must be connected to RF/DC ground. | |
| 3 | VPD | Power control pin. For maximum power, this pin should be connected to 5V. A higher voltage is not recommended. For lower idle current, this voltage can be reduced. | |
| 6 | RFIN | This pin is DC coupled. Off chip matching components are required. See Application Circuit herein. | |
| 11, 12 | RFOUT | RF output and DC Bias input for the output amplifier stage. Off chip matching components are required. See Application Circuit herein. | |

400 MHz Application Circuit

This circuit was used to specify the performance for 400-410 MHz operation. Contact the HMC Applications Group for assistance in optimizing performance for your application.

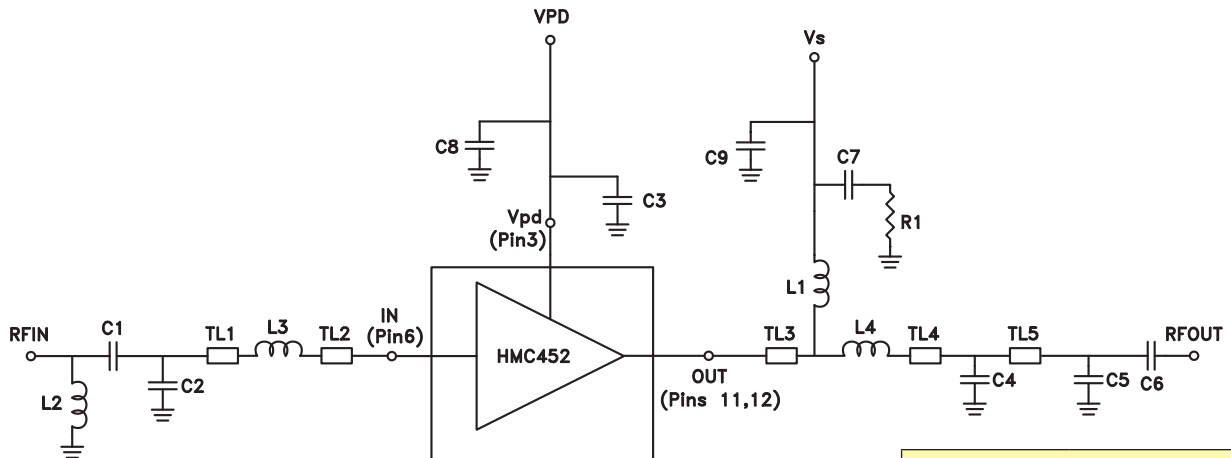

| Recommended Component Values | |
|------------------------------|----------|
| C1, C2 | 12 pF |
| C3, C7 | 100 pF |
| C4, C5 | 6.8 pF |
| C6 | 39 pF |
| C8, C9 | 2.2 μF |
| L1 | 47 nH |
| L2 | 40 nH |
| L3 | 4.7 nH |
| L4 | 5.6 nH |
| R1 | 5.1 Ohms |

Note: C3 should be placed as close to pins as possible.

| | TL1 | TL2 | TL3 | TL4 | TL5 |
|---|--------|--------|--------|--------|--------|
| Impedance | 50 Ohm | 50 Ohm | 50 Ohm | 50 Ohm | 50 Ohm |
| Physical Length | 0.11" | 0.06" | 0.12" | 0.04" | 0.16" |
| Electrical Length | 3° | 2° | 3° | 1° | 4° |
| PCB Material: 10 mil Rogers 4350, Er = 3.48 | | | | | |

Information furnished by Analog Devices is believed to be accurate and reliable. However, no responsibility is assumed by Analog Devices for its use, nor for any infringements of patents or other rights of third parties that may result from its use. Specifications subject to change without notice. No license is granted by implication or otherwise under any patent or patent rights of Analog Devices. Trademarks and registered trademarks are the property of their respective owners.

For price, delivery, and to place orders: Analog Devices, Inc., One Technology Way, P.O. Box 9106, Norwood, MA 02062-9106 Phone: 781-329-4700 • Order online at www.analog.com Application Support: Phone: 1-800-ANALOG-D

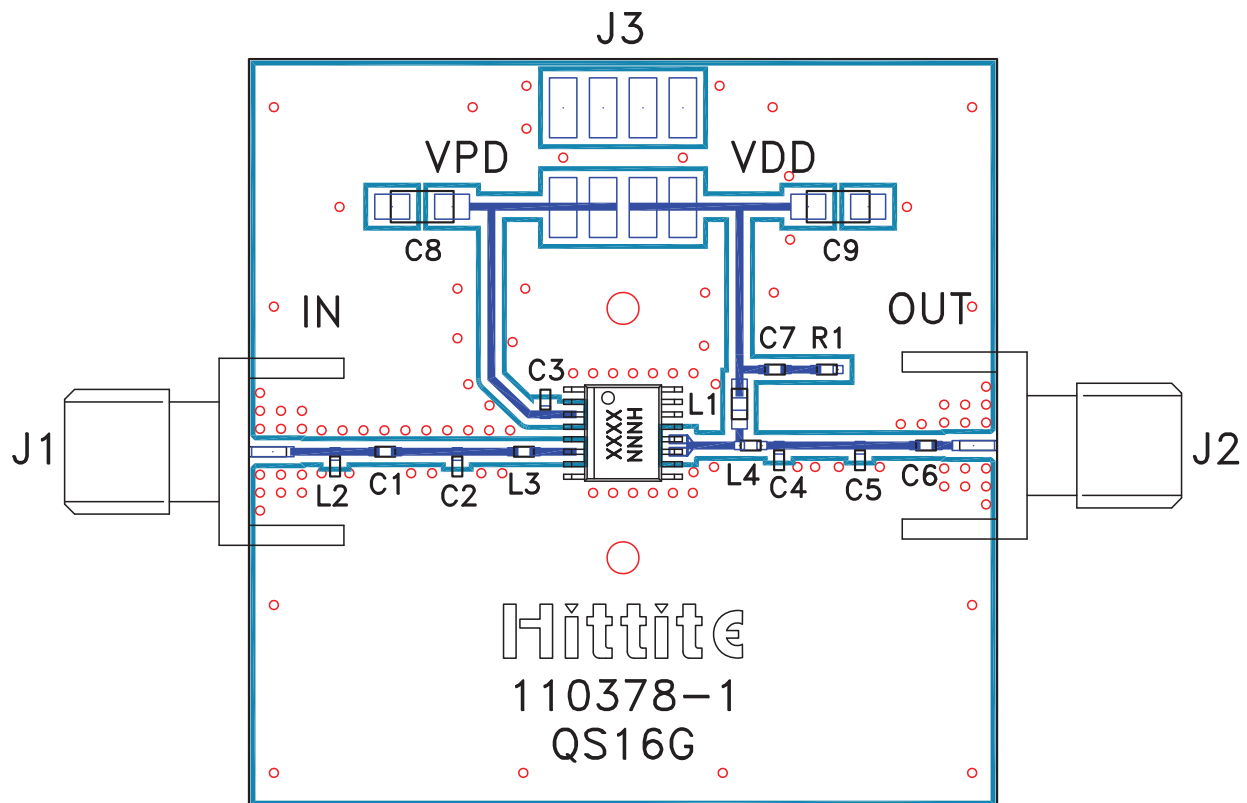
400 MHz Evaluation PCB

List of Materials for Evaluation PCB 110380-400 [1]

| Item | Description |
|---------|--|
| J1 - J2 | PCB Mount SMA Connector |
| J3 | 2 mm DC Header |
| C1, C2 | 12 pF Capacitor, 0402 Pkg. |
| C3, C7 | 100 pF Capacitor, 0402 Pkg. |
| C4, C5 | 6.8 pF Capacitor, 0402 Pkg. |
| C6 | 39 pF Capacitor, 0402 Pkg. |
| C8, C9 | 2.2 μ F Capacitor, Tantalum |
| L1 | 47 nH Inductor, 0603 Pkg. |
| L2 | 40 nH Inductor, 0402 Pkg. |
| L3 | 4.7 nH Inductor, 0402 Pkg. |
| L4 | 5.6 nH Inductor, 0402 Pkg. |
| R1 | 5.1 Ohm Resistor, 0402 Pkg. |
| U1 | HMC452QS16G / HMC452QS16GE Linear Amp |
| PCB [2] | 110378 Evaluation PCB, 10 mils |

[1] Reference this number when ordering complete evaluation PCB

[2] Circuit Board Material: Rogers 4350, Er = 3.48

The circuit board used in this application should use RF circuit design techniques. Signal lines should have 50 ohm impedance while the package ground leads and exposed paddle should be connected directly to the ground plane similar to that shown. A sufficient number of via holes should be used to connect the top and bottom ground planes. The evaluation board should be mounted to an appropriate heat sink. The evaluation circuit board shown is available from Hittite upon request.



470 MHz Application Circuit

This circuit was used to specify the performance for 450-496 MHz operation. Contact the HMC Applications Group for assistance in optimizing performance for your application.

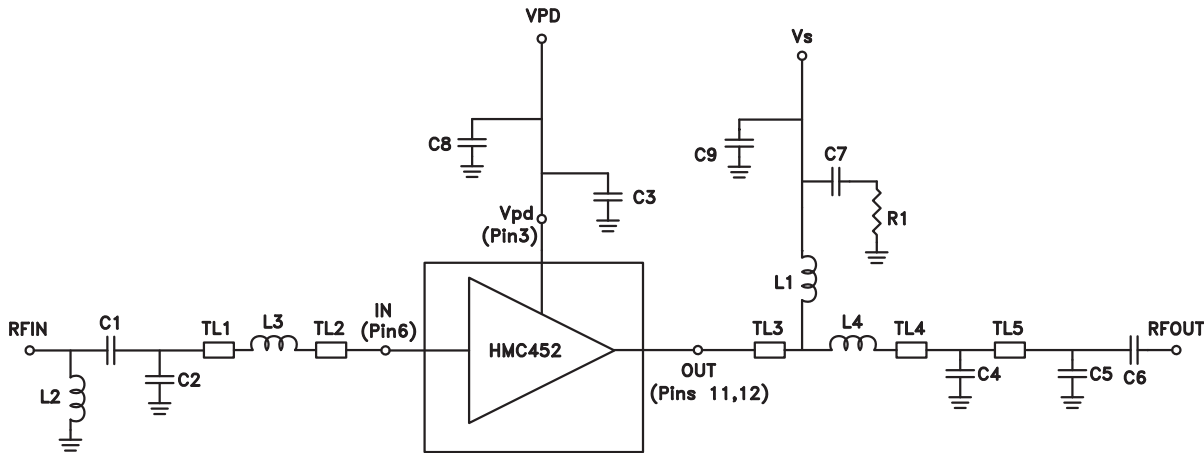

Note: C3 should be placed as close to pins as possible.

| | TL1 | TL2 | TL3 | TL4 | TL5 |
|---|--------|--------|--------|--------|--------|
| Impedance | 50 Ohm | 50 Ohm | 50 Ohm | 50 Ohm | 50 Ohm |
| Physical Length | 0.11" | 0.06" | 0.12" | 0.04" | 0.16" |
| Electrical Length | 3° | 2° | 3° | 1° | 4° |
| PCB Material: 10 mil Rogers 4350, Er = 3.48 | | | | | |

| Recommended Component Values | |
|------------------------------|----------|
| C1, C2 | 12 pF |
| C3, C7 | 100 pF |
| C4 | 6.8 pF |
| C5 | 5.6 pF |
| C6 | 39 pF |
| C8, C9 | 2.2 μF |
| L1 | 47 nH |
| L2 | 40 nH |
| L3 | 3.9 nH |
| L4 | 4.3 nH |
| R1 | 5.1 Ohms |



470 MHz Evaluation PCB

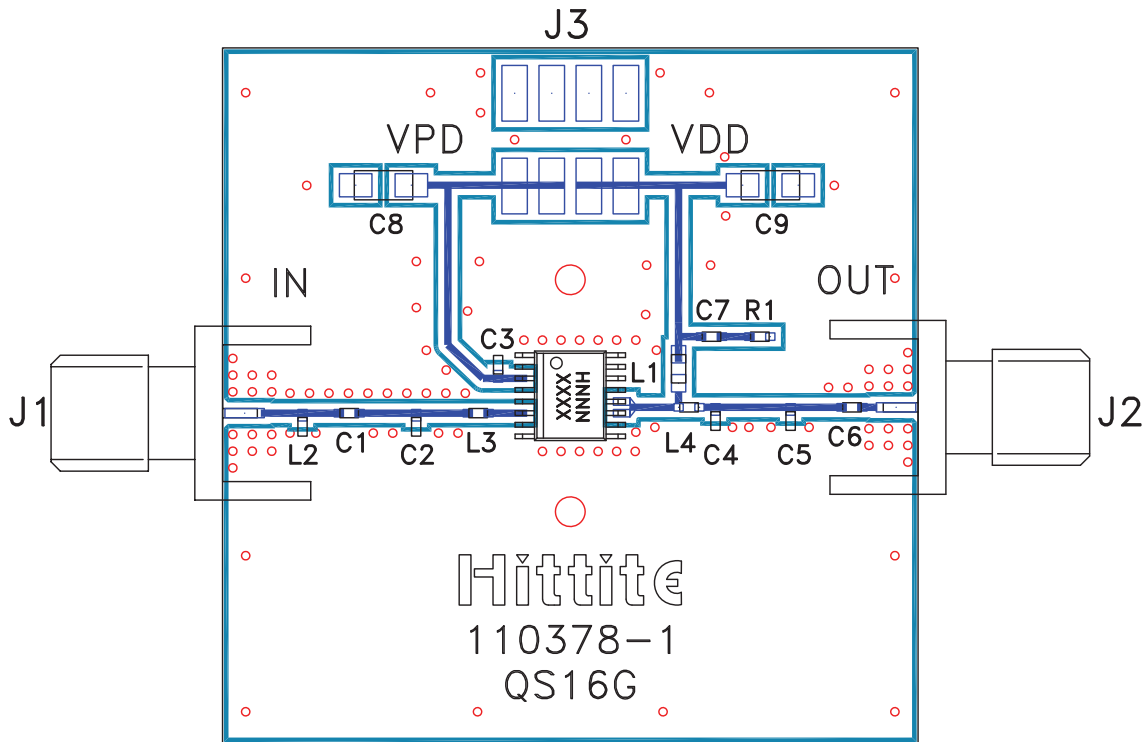

List of Materials for Evaluation PCB 110381-470 [1]

| Item | Description |
|---------|---------------------------------------|
| J1 - J2 | PCB Mount SMA Connector |
| J3 | 2 mm DC Header |
| C1, C2 | 12 pF Capacitor, 0402 Pkg. |
| C3, C7 | 100 pF Capacitor, 0402 Pkg. |
| C4 | 6.8 pF Capacitor, 0402 Pkg. |
| C5 | 5.6 pF Capacitor, 0402 Pkg. |
| C6 | 39 pF Capacitor, 0402 Pkg. |
| C8, C9 | 2.2 µF Capacitor, Tantalum |
| L1 | 47 nH Inductor, 0603 Pkg. |
| L2 | 40 nH Inductor, 0402 Pkg. |
| L3 | 3.9 nH Inductor, 0402 Pkg. |
| L4 | 4.3 nH Inductor, 0402 Pkg. |
| R1 | 5.1 Ohm Resistor, 0402 Pkg. |
| U1 | HMC452QS16G / HMC452QS16GE Linear Amp |
| PCB [2] | 110378 Evaluation PCB, 10 mils |

[1] Reference this number when ordering complete evaluation PCB

[2] Circuit Board Material: Rogers 4350, Er = 3.48

The circuit board used in this application should use RF circuit design techniques. Signal lines should have 50 ohm impedance while the package ground leads and exposed paddle should be connected directly to the ground plane similar to that shown. A sufficient number of via holes should be used to connect the top and bottom ground planes. The evaluation board should be mounted to an appropriate heat sink. The evaluation circuit board shown is available from Hittite upon request.



InGaP HBT 1 WATT POWER AMPLIFIER, 0.4 - 2.2 GHz

900 MHz Application Circuit

This circuit was used to specify the performance for 810-960 MHz operation. Contact the HMC Applications Group for assistance in optimizing performance for your application.

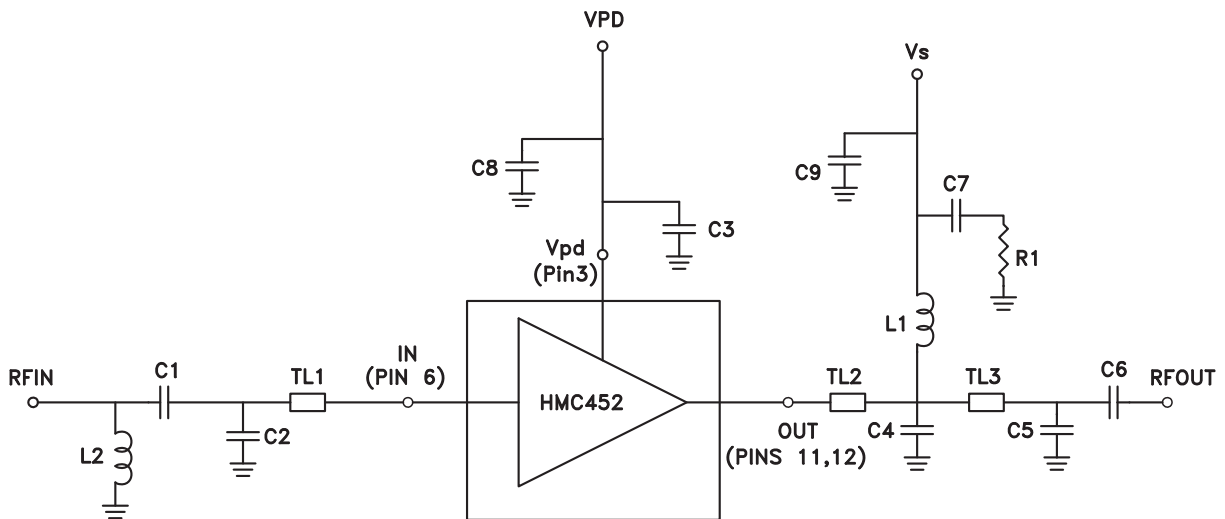

Note: C3 should be placed as close to pins as possible.

| | TL1 | TL2 | TL3 |
|---|--------|--------|--------|
| Impedance | 50 Ohm | 50 Ohm | 50 Ohm |
| Physical Length | 0.21" | 0.19" | 0.23" |
| Electrical Length | 11° | 10° | 12° |
| PCB Material: 10 mil Rogers 4350, Er = 3.48 | | | |

| Recommended Component Values | |
|------------------------------|-------------|
| C1 | 10 pF |
| C2, C6 | 5.6 pF |
| C3, C7 | 100 pF |
| C4 | 2.2 pF |
| C5 | 5 pF |
| C8, C9 | 2.2 μ F |
| L1, L2 | 20 nH |
| R1 | 5.6 Ohm |



900 MHz Evaluation PCB

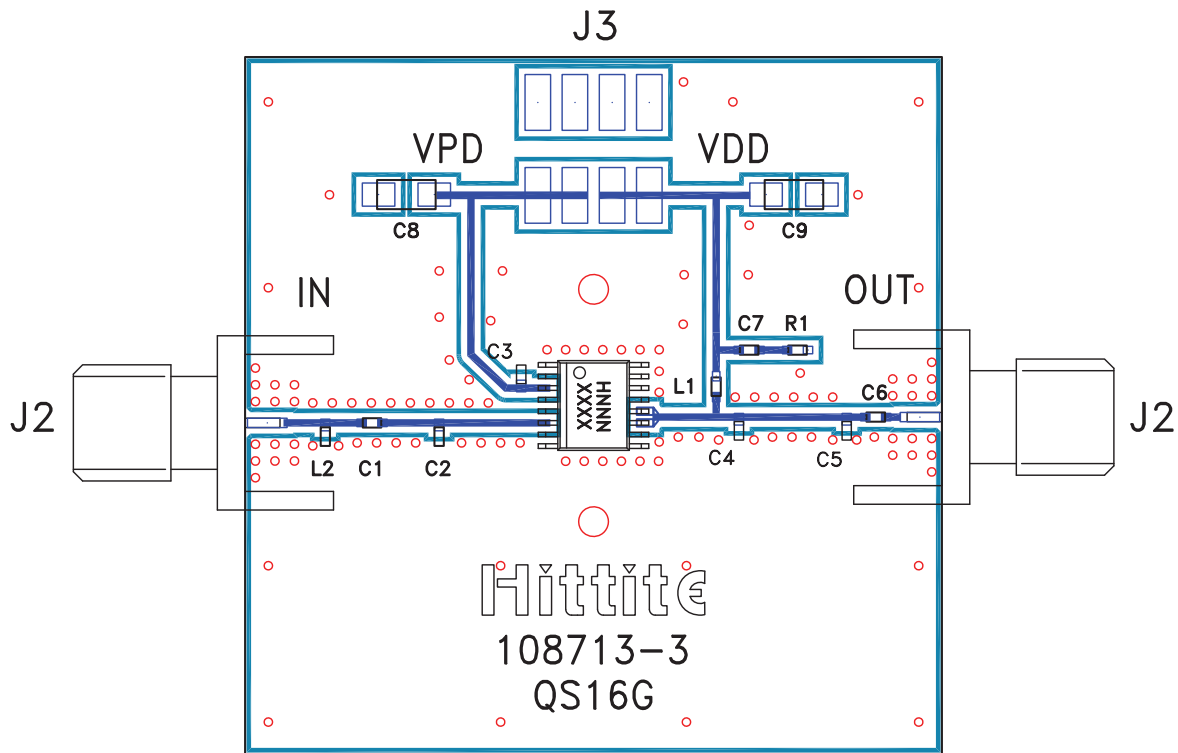

List of Materials for Evaluation PCB 108715-900 [1]

| Item | Description |
|---------|---------------------------------------|
| J1 - J2 | PCB Mount SMA Connector |
| J3 | 2 mm DC Header |
| C1 | 10 pF Capacitor, 0402 Pkg. |
| C2, C6 | 5.6 pF Capacitor, 0402 Pkg. |
| C3, C7 | 100 pF Capacitor, 0402 Pkg. |
| C4 | 2.2 pF Capacitor, 0402 Pkg. |
| C5 | 5 pF Capacitor, 0402 Pkg. |
| C8, C9 | 2.2 μF Capacitor, Tantalum |
| L1, L2 | 20 nH Inductor, 0402 Pkg. |
| R1 | 5.6 Ohm Resistor, 0402 Pkg. |
| U1 | HMC452QS16G / HMC452QS16GE Linear Amp |
| PCB [2] | 108713 Evaluation PCB, 10 mils |

[1] Reference this number when ordering complete evaluation PCB

[2] Circuit Board Material: Rogers 4350, Er = 3.48

The circuit board used in this application should use RF circuit design techniques. Signal lines should have 50 ohm impedance while the package ground leads and exposed paddle should be connected directly to the ground plane similar to that shown. A sufficient number of via holes should be used to connect the top and bottom ground planes. The evaluation board should be mounted to an appropriate heat sink. The evaluation circuit board shown is available from Hittite upon request.



1900 MHz Application Circuit

This circuit was used to specify the performance for 1710-1990 MHz operation. Contact the HMC Applications Group for assistance in optimizing performance for your application.

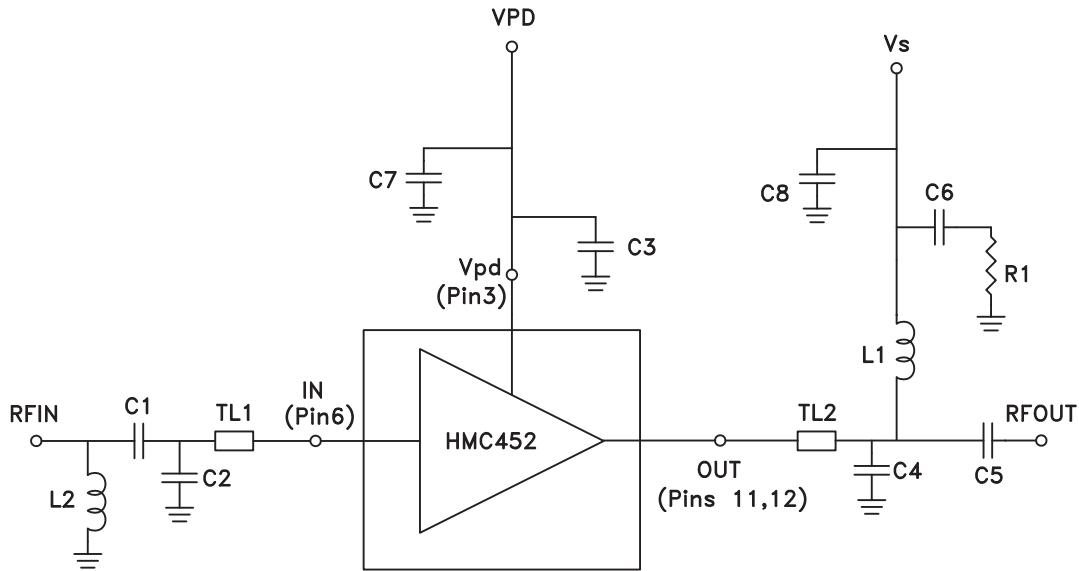

Note: C2, C3 and C4 should be placed as close to pins as possible.

| | TL1 | TL2 |
|---|--------|--------|
| Impedance | 50 Ohm | 50 Ohm |
| Physical Length | 0.04" | 0.08" |
| Electrical Length | 4° | 9° |
| PCB Material: 10 mil Rogers 4350, Er = 3.48 | | |

| Recommended Component Values | |
|------------------------------|----------|
| C1 | 2.7 pF |
| C2 | 2 pF |
| C3, C5, C6 | 100 pF |
| C4 | 3.3 pF |
| C7, C8 | 2.2 μF |
| L1, L2 | 20 nH |
| R1 | 5.6 Ohms |



1900 MHz Evaluation PCB

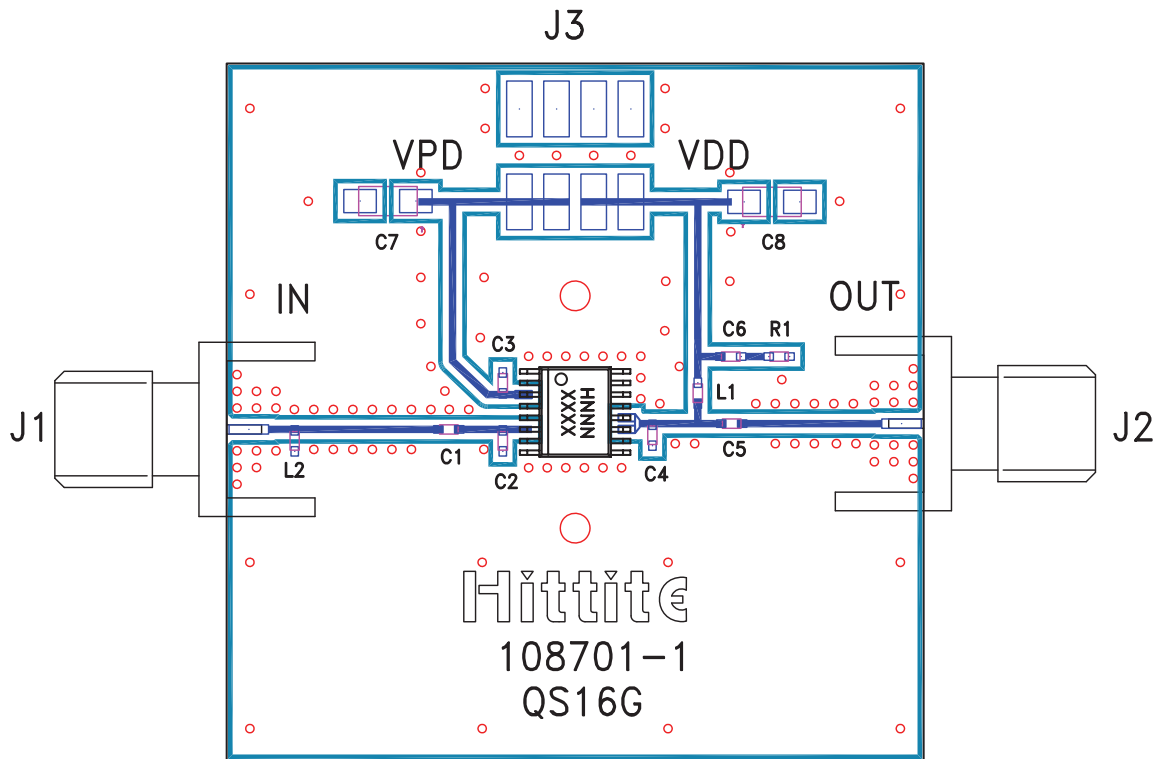

List of Materials for Evaluation PCB 108703-1900 [1]

| Item | Description |
|------------|---------------------------------------|
| J1 - J2 | PCB Mount SMA Connector |
| J3 | 2 mm DC Header |
| C1 | 2.7 pF Capacitor, 0402 Pkg. |
| C2 | 2 pF Capacitor, 0402 Pkg. |
| C3, C5, C6 | 100 pF Capacitor, 0402 Pkg. |
| C4 | 3.3 pF Capacitor, 0402 Pkg. |
| C7, C8 | 2.2 μF Capacitor, Tantalum |
| L1, L2 | 20 nH Inductor, 0402 Pkg. |
| R1 | 5.6 Ohm Resistor, 0402 Pkg. |
| U1 | HMC452QS16G / HMC452QS16GE Linear Amp |
| PCB [2] | 108701 Evaluation PCB, 10 mils |

[1] Reference this number when ordering complete evaluation PCB

[2] Circuit Board Material: Rogers 4350, Er = 3.48

The circuit board used in this application should use RF circuit design techniques. Signal lines should have 50 ohm impedance while the package ground leads and exposed paddle should be connected directly to the ground plane similar to that shown. A sufficient number of via holes should be used to connect the top and bottom ground planes. The evaluation board should be mounted to an appropriate heat sink. The evaluation circuit board shown is available from Hittite upon request.



2100 MHz Application Circuit

This circuit was used to specify the performance for 2010-2170 MHz operation. Contact the HMC Applications Group for assistance in optimizing performance for your application.

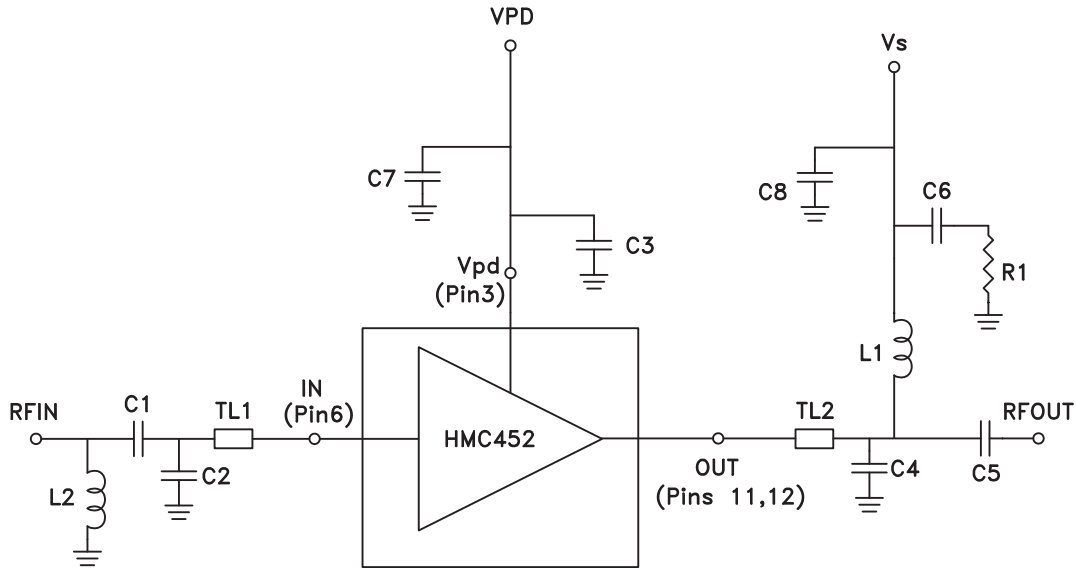

Note: C2, C3 and C4 should be placed as close to pins as possible.

| | TL1 | TL2 |
|---|--------|--------|
| Impedance | 50 Ohm | 50 Ohm |
| Physical Length | 0.04" | 0.08" |
| Electrical Length | 5° | 10° |
| PCB Material: 10 mil Rogers 4350, Er = 3.48 | | |

| Recommended Component Values | |
|------------------------------|----------|
| C1 | 4.7 pF |
| C2 | 2 pF |
| C3, C6 | 100 pF |
| C4 | 3.3 pF |
| C5 | 15 pF |
| C7, C8 | 2.2 μF |
| L1 | 12 nH |
| L2 | 10 nH |
| R1 | 5.1 Ohms |



2100 MHz Evaluation PCB

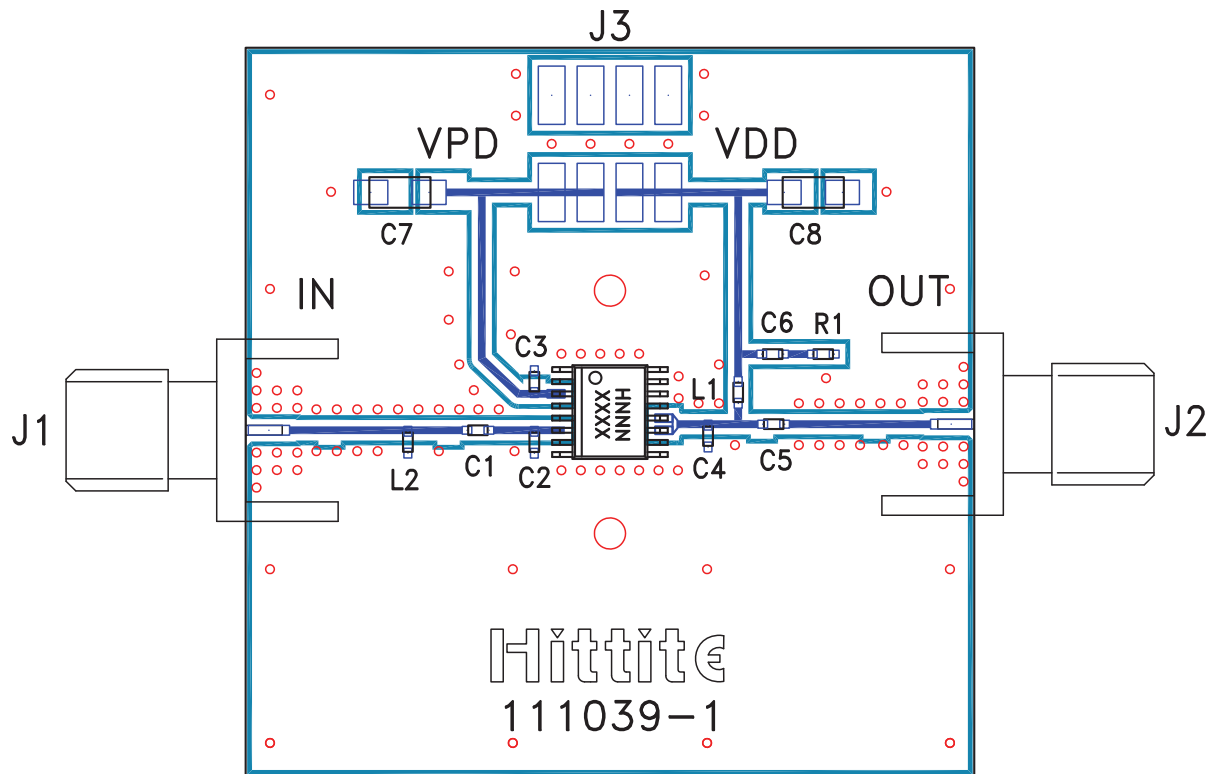

List of Materials for Evaluation PCB 111041-2100 [1]

| Item | Description |
|---------|--|
| J1 - J2 | PCB Mount SMA Connector |
| J3 | 2 mm DC Header |
| C1 | 4.7 pF Capacitor, 0402 Pkg. |
| C2 | 2 pF Capacitor, 0402 Pkg. |
| C3, C6 | 100 pF Capacitor, 0402 Pkg. |
| C4 | 3.3 pF Capacitor, 0402 Pkg. |
| C5 | 15 pF Capacitor, 0402 Pkg. |
| C7, C8 | 2.2 μF Capacitor, Tantalum |
| L1 | 12 nH Inductor, 0402 Pkg. |
| L2 | 10 nH Inductor, 0402 Pkg. |
| R1 | 5.1 Ohm Resistor, 0402 Pkg. |
| U1 | HMC452QS16G / HMC452QS16GE Linear Amp |
| PCB [2] | 111039 Evaluation PCB, 10 mils |

[1] Reference this number when ordering complete evaluation PCB

[2] Circuit Board Material: Rogers 4350, Er = 3.48

The circuit board used in this application should use RF circuit design techniques. Signal lines should have 50 ohm impedance while the package ground leads and exposed paddle should be connected directly to the ground plane similar to that shown. A sufficient number of via holes should be used to connect the top and bottom ground planes. The evaluation board should be mounted to an appropriate heat sink. The evaluation circuit board shown is available from Hittite upon request.

Information furnished by Analog Devices is believed to be accurate and reliable. However, no responsibility is assumed by Analog Devices for its use, nor for any infringements of patents or other rights of third parties that may result from its use. Specifications subject to change without notice. No license is granted by implication or otherwise under any patent or patent rights of Analog Devices. Trademarks and registered trademarks are the property of their respective owners.

For price, delivery, and to place orders: Analog Devices, Inc., One Technology Way, P.O. Box 9106, Norwood, MA 02062-9106 Phone: 781-329-4700 • Order online at www.analog.com Application Support: Phone: 1-800-ANALOG-D

Looking for pricing, stock, or lifecycle information?

Click below to explore more details on WIN SOURCE:

 [View 110380-HMC452QS16G on WIN SOURCE](#)

 [Analog Devices Inc. Information](#)

Optimize Your Supply Chain with WIN SOURCE Solutions

-  Global Sourcing Solution
-  Obsolete Management
-  Cost Control Management
-  Shortage Management
-  Alternative Solution
-  Excess Inventory Management