

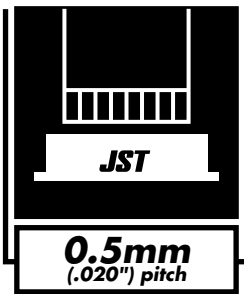

**THE DATASHEET OF
10FLZ-RSM1-TB**





FLZ CONNECTOR

Connectors for FFC and FPC



This extremely small 0.5mm (.020") pitch connector with a height of only 2.0mm (.079") above the PCB surface allows interconnection in extremely small spaces and is an example of JST's leading edge technology.

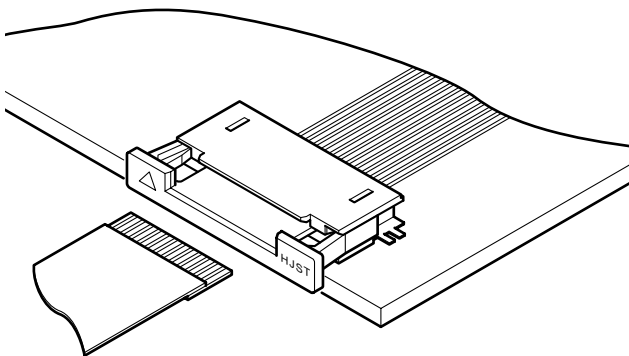

Features

- **Zero insertion force mechanism**

A ZIF mechanism increases wear resistance and extends the connector's mating life.

- **Heat resistant design suitable for surface mounting**

This housing is made of heat resistant plastic to allow reflow soldering.

- **In-line surface mount tails**

Has an in-line surface mount tails for easy inspection.

- **Two types of connections**

The connector is available in either the normal or reverse configurations. The FFC/FPC is positioned with its mating surfaces facing upward for the normal configured connector, while the reverse configuration requires that the FFC/FPC be positioned with its mating surfaces facing down. The engineer has greater freedom in designing his circuitry.

- **Embossed tape for automatic mounting**

The FLZ connector can be packaged in embossed tape for automatic mounting.

Specifications

- Current rating: 0.5A AC, DC
- Voltage rating: 50V AC, DC
- Temperature range: -25°C to +85°C
(including temperature rise in applying electrical current)
- Contact resistance: Initial value/40m Ω max.
After environmental testing/60m Ω max.
- Insulation resistance: 800M Ω min.
- Withstanding voltage: 200V AC/minute
- Applicable FFC and FPC: Lead pitch/0.5mm(.020")
Lead width/0.35mm(.014")
Mating part thickness/
0.30±0.03mm(.012" ± .001")

<Note>FFC and FPC to be actually used should be checked for applicability.

- * Contact JST if Lead-Free product is required.
- * Refer to "General Instruction and Notice when using Terminals and Connectors" at the end of this catalog.
- * Contact JST for details.

Standards

⚡ Recognized E60389

Ⓢ Certified LR20812

Connector

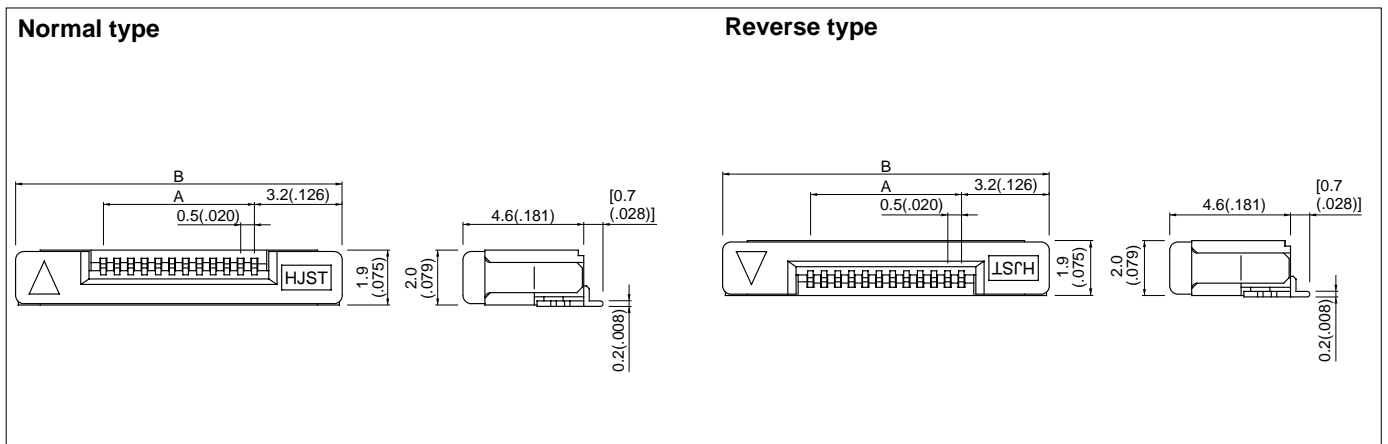

Cir- cuits	Model No.		Dimensions mm(in.)		Q'ty / reel
	Normal type	Reverse type	A	B	
6	06FLZ-SM1-TB	06FLZ-RSM1-TB	2.5(.098)	8.9(.350)	2,000
7	07FLZ-SM1-TB	07FLZ-RSM1-TB	3.0(.118)	9.4(.370)	2,000
8	08FLZ-SM1-TB	08FLZ-RSM1-TB	3.5(.138)	9.9(.390)	2,000
9	09FLZ-SM1-TB	09FLZ-RSM1-TB	4.0(.157)	10.4(.409)	2,000
10	10FLZ-SM1-TB	10FLZ-RSM1-TB	4.5(.177)	10.9(.429)	2,000
11	11FLZ-SM1-TB	11FLZ-RSM1-TB	5.0(.197)	11.4(.449)	2,000
12	12FLZ-SM1-TB	12FLZ-RSM1-TB	5.5(.217)	11.9(.469)	2,000
13	13FLZ-SM1-TB	13FLZ-RSM1-TB	6.0(.236)	12.4(.488)	2,000
14	14FLZ-SM1-TB	14FLZ-RSM1-TB	6.5(.256)	12.9(.508)	2,000
15	15FLZ-SM1-TB	15FLZ-RSM1-TB	7.0(.276)	13.4(.528)	2,000
16	16FLZ-SM1-TB	16FLZ-RSM1-TB	7.5(.295)	13.9(.547)	2,000
17	17FLZ-SM1-TB	17FLZ-RSM1-TB	8.0(.315)	14.4(.567)	2,000
18	18FLZ-SM1-TB	18FLZ-RSM1-TB	8.5(.335)	14.9(.587)	2,000
19	19FLZ-SM1-TB	19FLZ-RSM1-TB	9.0(.354)	15.4(.606)	2,000
20	20FLZ-SM1-TB	20FLZ-RSM1-TB	9.5(.374)	15.9(.626)	2,000
21	21FLZ-SM1-TB	21FLZ-RSM1-TB	10.0(.394)	16.4(.646)	2,000
22	22FLZ-SM1-TB	22FLZ-RSM1-TB	10.5(.413)	16.9(.665)	2,000
23	23FLZ-SM1-TB	23FLZ-RSM1-TB	11.0(.433)	17.4(.685)	2,000
24	24FLZ-SM1-TB	24FLZ-RSM1-TB	11.5(.453)	17.9(.705)	2,000
25	25FLZ-SM1-TB	25FLZ-RSM1-TB	12.0(.472)	18.4(.724)	2,000
26	26FLZ-SM1-TB	26FLZ-RSM1-TB	12.5(.492)	18.9(.744)	2,000
27	27FLZ-SM1-TB	27FLZ-RSM1-TB	13.0(.512)	19.4(.764)	2,000
28	28FLZ-SM1-TB	28FLZ-RSM1-TB	13.5(.531)	19.9(.783)	2,000
30	30FLZ-SM1-TB	30FLZ-RSM1-TB	14.5(.571)	20.9(.823)	2,000
33	33FLZ-SM1-TB	-	16.0(.630)	22.4(.882)	2,000

Material and Finish

Contact: Phosphor bronze, tin/lead-plated
 Slider housing: Nylon 46, UL94V-0 (black)
 Receptacle housing: Nylon 46, UL94V-0
 ()FLZ-SM1-TB, gray
 ()FLZ-RSM1-TB, natural
 Solder tab: Phosphor bronze, tin/lead-plated

Note: The products listed above are supplied on embossed tape.

FLZ CONNECTOR

Connector <Inner-lock type>

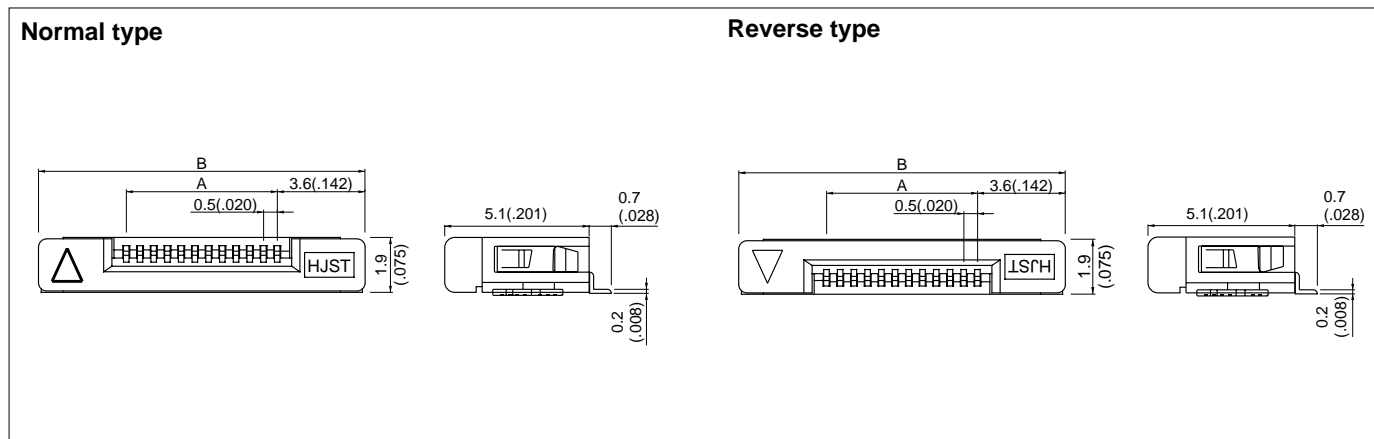

Cir- cuits	Model No.		Dimensions mm(in.)		Q'ty / reel
	Normal type	Reverse type	A	B	
13	-	13FLZ-RSM1-R-TB	6.0(.236)	13.1(.516)	2,000
30	30FLZ-SM1-R-TB	-	14.5(.571)	21.6(.850)	2,000
32	32FLZ-SM1-R-TB	32FLZ-RSM1-R-TB	15.5(.610)	22.6(.890)	2,000
34	34FLZ-SM1-R-TB	34FLZ-RSM1-R-TB	16.5(.650)	23.6(.929)	2,000
36	36FLZ-SM1-R-TB	36FLZ-RSM1-R-TB	17.5(.689)	24.6(.969)	2,000
40	40FLZ-SM1-R-TB	40FLZ-RSM1-R-TB	19.5(.768)	26.6(1.047)	2,000
42	42FLZ-SM1-R-TB	-	20.5(.807)	27.6(1.087)	2,000
45	45FLZ-SM1-R-TB	-	22.0(.866)	29.1(1.146)	2,000
50	50FLZ-SM1-R-TB	-	24.5(.965)	31.6(1.244)	2,000

Material and Finish

Contact: Phosphor bronze, tin/lead-plated
 Slider housing: Nylon 46, UL94V-0 (black)
 Receptacle housing: Nylon 46, UL94V-0
 ()FLZ-SM1-R-TB, gray
 ()FLZ-RSM1-R-TB, natural
 Solder tab: Phosphor bronze, tin/lead-plated

Note: 1. The products listed above are supplied on embossed tape.
 2. 45FLZ-SM1-R-TB and 50FLZ-SM1-R-TB are not CSA approved.

FLZ CONNECTOR

PC board layout (viewed from component side) and Assembly layout

(6 to 33 circuits)

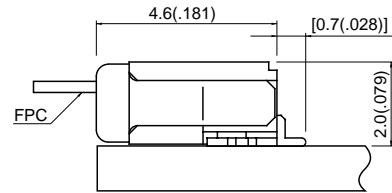
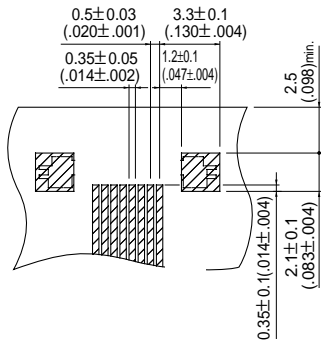

(13 to 50 circuits) <Inner-lock type>

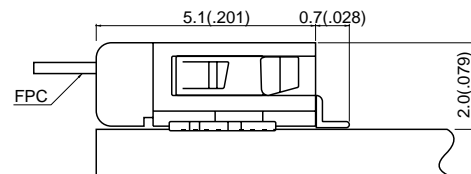
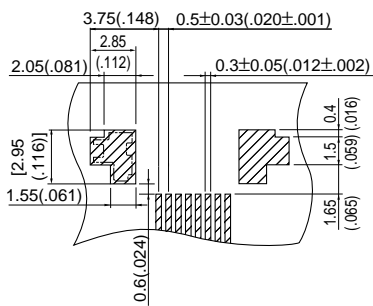

Note:

1. Tolerances are non-cumulative: $\pm 0.03\text{mm}(\pm 0.001")$ for all centers.
2. The dimensions above should serve as a guideline.
Contact JST for details.

Looking for pricing, stock, or lifecycle information?

Click below to explore more details on WIN SOURCE:

-  [View 10FLZ-RSM1-TB on WIN SOURCE](#)
-  [JST Sales America Inc. Information](#)

Optimize Your Supply Chain with WIN SOURCE Solutions

-  Global Sourcing Solution
-  Obsolete Management
-  Cost Control Management
-  Shortage Management
-  Alternative Solution
-  Excess Inventory Management