



# THE DATASHEET OF 10DBAG5





**ELECTRICAL SCHEMATIC**

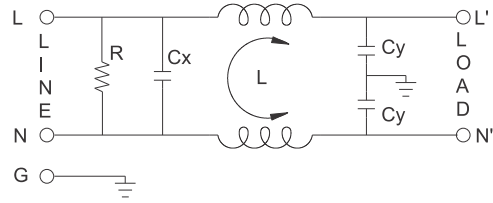
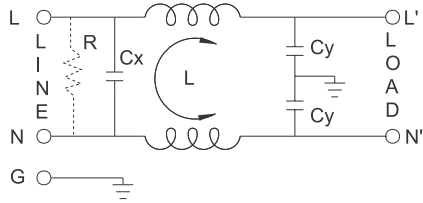

XXDBXX5B

**INSERTION LOSS (TYPICAL)**

02DBAG5 --- COMMON MODE --- DIFF. MODE  
 03DBAG5 --- COMMON MODE --- DIFF. MODE

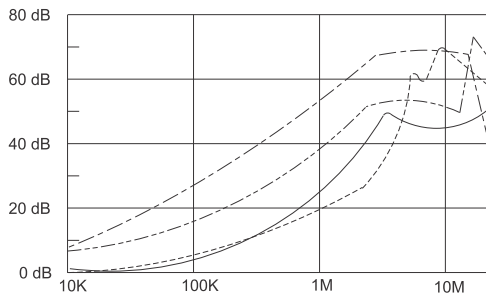

05DBAG5 --- COMMON MODE --- DIFF. MODE  
 10DBAG5 --- COMMON MODE --- DIFF. MODE

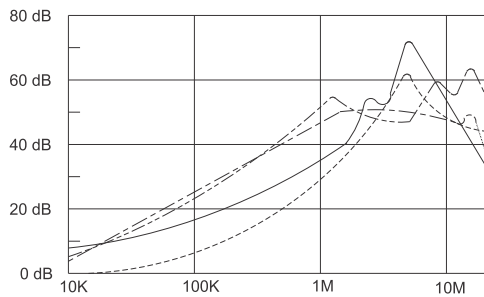

20DBAG5 --- COMMON MODE --- DIFF. MODE

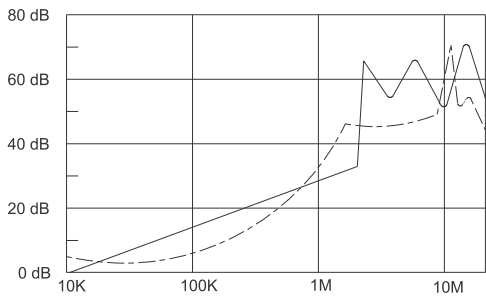

20DBC5B --- COMMON MODE --- DIFF. MODE  
 20BCS5B --- COMMON MODE --- DIFF. MODE  
 30BCS5B --- COMMON MODE --- DIFF. MODE

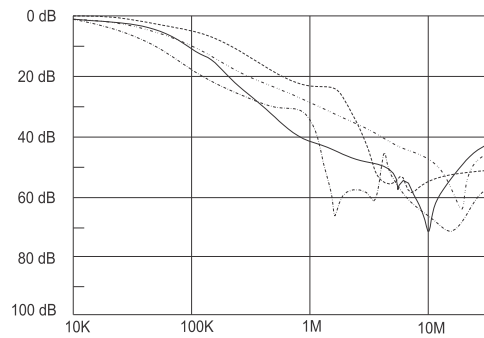

12DBBG5B --- COMMON MODE --- DIFF. MODE

16DBC5B --- COMMON MODE --- DIFF. MODE  
 16BCW5B --- COMMON MODE --- DIFF. MODE

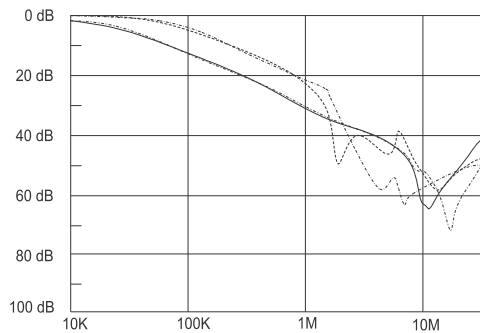

**MECHANICAL CONSTRUCTION**

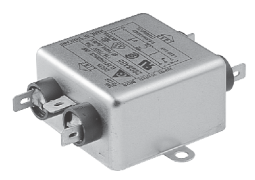

AG5

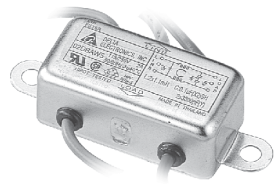
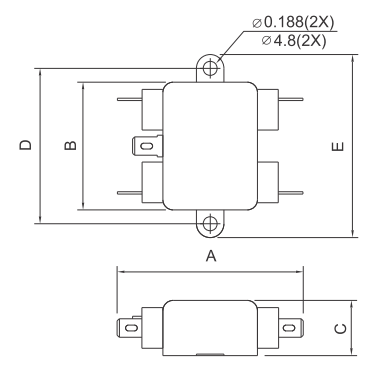

AW5

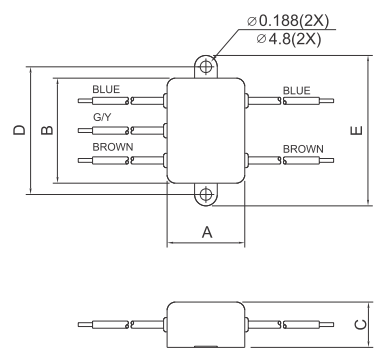

DW3S

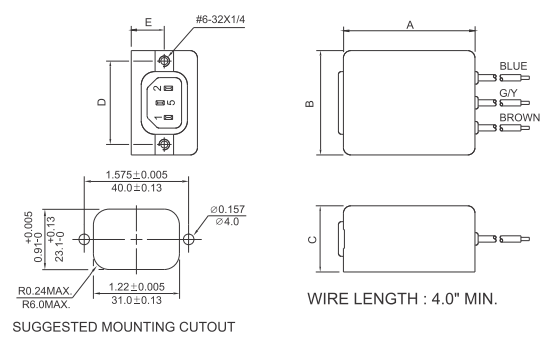

UNIT:  $\frac{\text{INCH}}{\text{mm}}$

**MECHANICAL CONSTRUCTION**



DG3

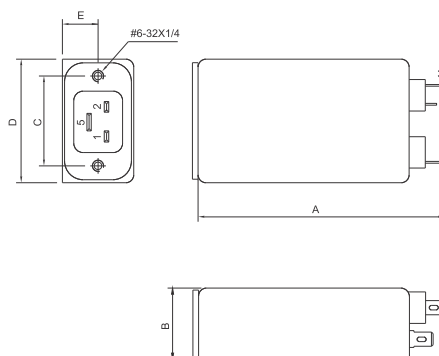

DG3S

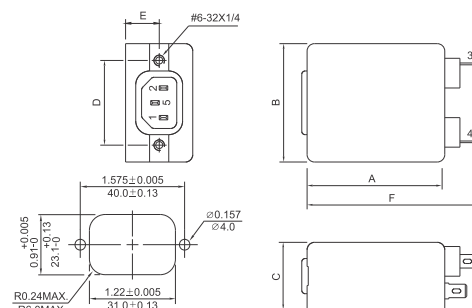

SUGGESTED MOUNTING CUTOUT

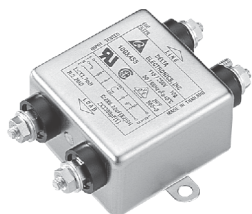

AS5

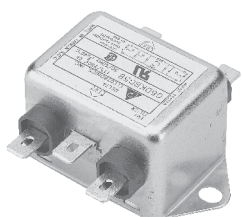
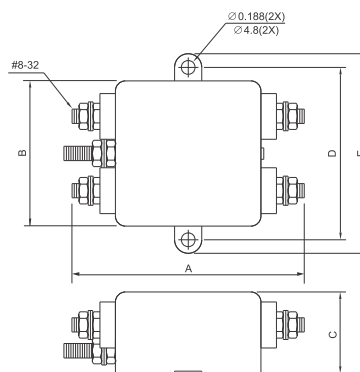

BG5B  
(option wire style)

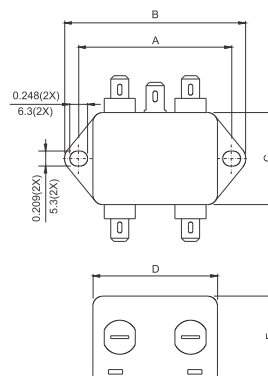

**MECHANICAL CONSTRUCTION**



CG5B



CW5B



CS5B

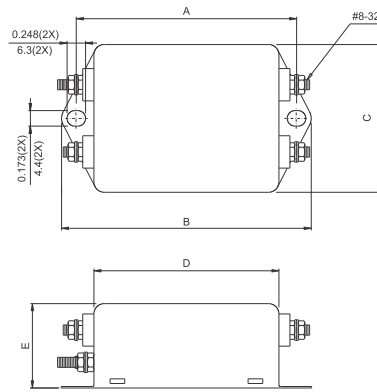
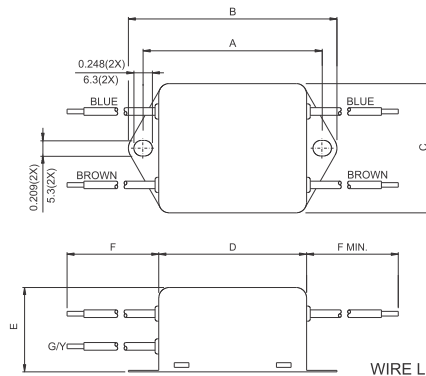
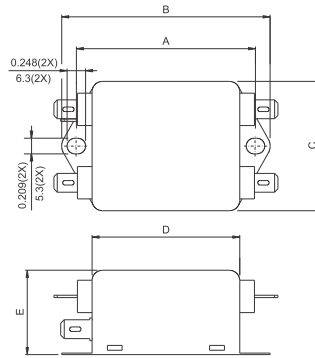

UNIT:  $\frac{\text{INCH}}{\text{mm}}$

## Looking for pricing, stock, or lifecycle information?

Click below to explore more details on WIN SOURCE:

- [View 10DBAG5 on WIN SOURCE](#)
- [Delta Electronics Information](#)

## Optimize Your Supply Chain with WIN SOURCE Solutions

- ✓ Global Sourcing Solution
- ✓ Obsolete Management
- ✓ Cost Control Management
- ✓ Shortage Management
- ✓ Alternative Solution
- ✓ Excess Inventory Management