



**THE DATASHEET OF  
103350-HMC410AMS8G**





## GaAs MMIC DOUBLE-BALANCED HIGH IP3 MIXER, 9 - 15 GHz

### Typical Applications

The HMC410AMS8G(E) is ideal for:

- Long Haul Radio Platforms
- Microwave Radio
- VSAT

### Features

- Conversion Loss: 8 dB
- LO/RF Isolation: 40 dB
- LO/IF Isolation: 37 dB
- Input IP3: +24 dBm
- No External Components
- MSOP8G SMT Package

### Functional Diagram

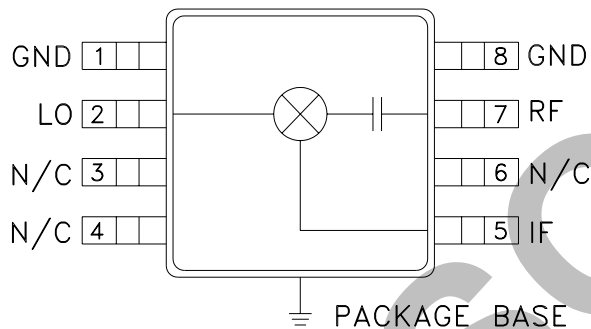

### General Description

The HMC410AMS8G(E) is a passive double-balanced high IP3 mixer that operates between 9 and 15 GHz. The HMC410AMS8G(E) operates with LO drive levels between +13 dBm and +19 dBm, and provides 8 dB conversion loss across the entire specified frequency band. These mixers require no external components or bias.

### Electrical Specifications, $T_A = +25^\circ C$

Parameter	IF = 1.45 GHz LO = +17 dBm			Units
	Min.	Typ.	Max.	
Frequency Range, RF & LO	9 - 15			GHz
Frequency Range, IF	DC - 2.5			GHz
Conversion Loss		8	11	dB
Noise Figure (SSB)		8	11	dB
LO to RF Isolation	30	40 - 45		dB
LO to IF Isolation	30	37		dB
RF to IF Isolation	8	17		dB
IP3 (Input)	20	24		dBm
1 dB Compression (Input)	11	14		dBm

\* Unless otherwise noted, all measurements performed as downconverter, IF = 1.45 GHz.



**GaAs MMIC DOUBLE-BALANCED HIGH IP3 MIXER, 9 - 15 GHz**

**Conversion Gain vs. Temperature @ LO = +17 dBm**

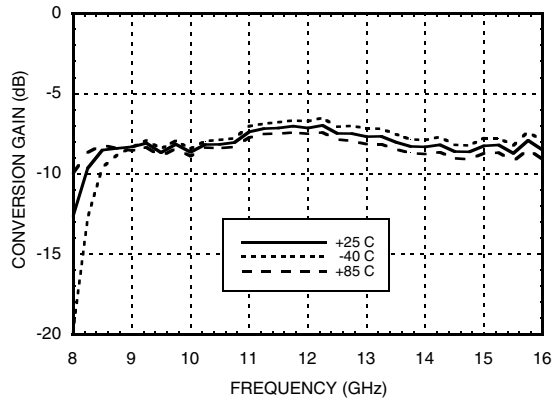

**Isolation @ LO = +17 dBm**

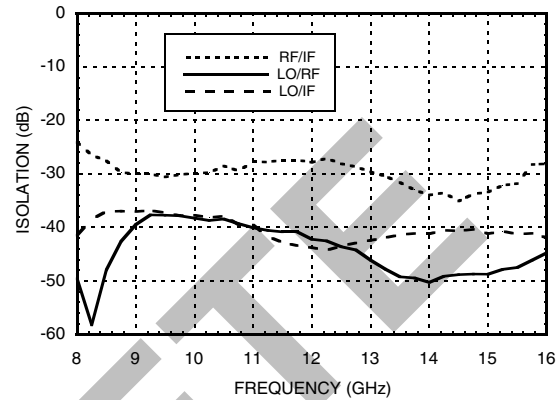

**Conversion Gain vs. LO Drive**

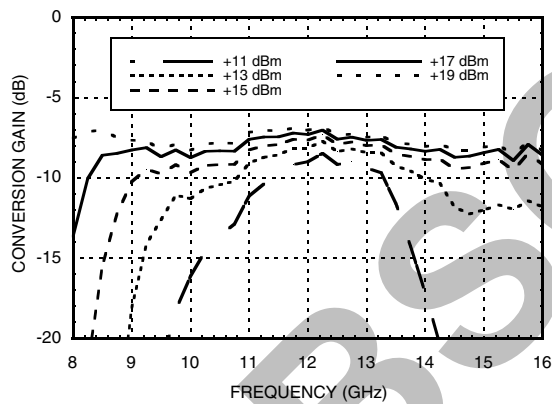

**Return Loss @ LO = +17 dBm**

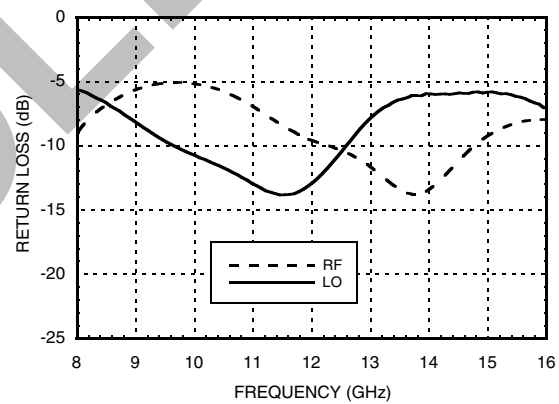

**IF Bandwidth @ LO = +17 dBm**

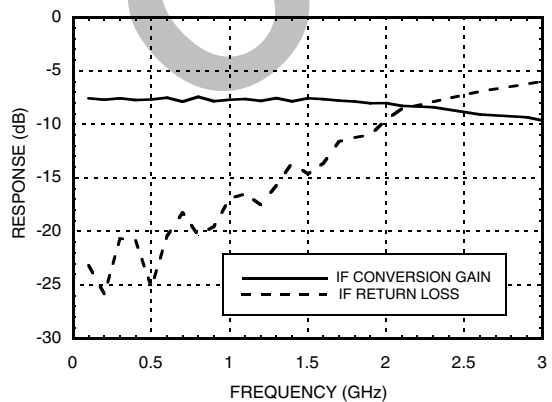

**Upconverter Performance Conversion Gain @ LO = +17 dBm**

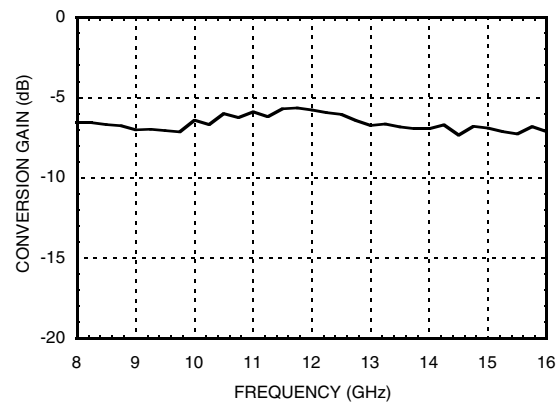

Information furnished by Analog Devices is believed to be accurate and reliable. However, no responsibility is assumed by Analog Devices for its use, nor for any infringements of patents or other rights of third parties that may result from its use. Specifications subject to change without notice. No license is granted by implication or otherwise under any patent or patent rights of Analog Devices. Trademarks and registered trademarks are the property of their respective owners.

For price, delivery, and to place orders: Analog Devices, Inc., One Technology Way, P.O. Box 9106, Norwood, MA 02062-9106 Phone: 781-329-4700 • Order online at [www.analog.com](http://www.analog.com) Application Support: Phone: 1-800-ANALOG-D

10

MIXERS - SINGLE & DOUBLE BALANCED - SMT



**GaAs MMIC DOUBLE-BALANCED HIGH IP3 MIXER, 9 - 15 GHz**

**Input IP3 vs. LO Drive\***

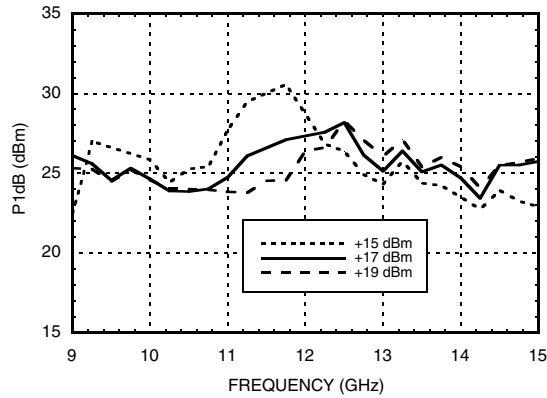

**Input IP3 vs. Temperature @ LO = +17 dBm\***

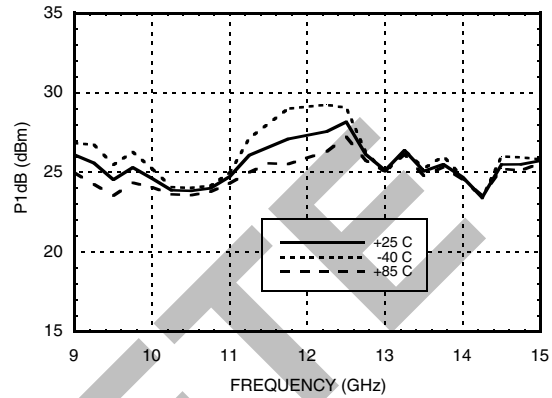

**Input IP2 vs. LO Drive \***

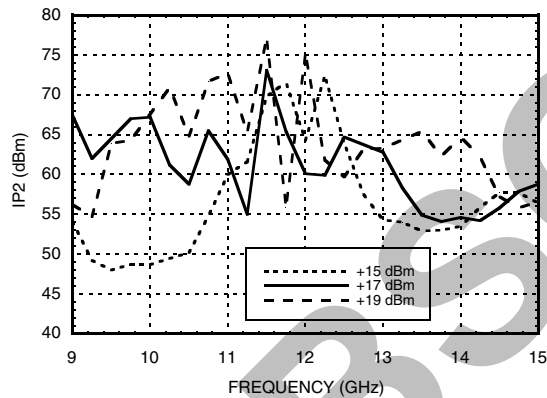

**Input P1dB vs. Temperature @ LO = +17 dBm**

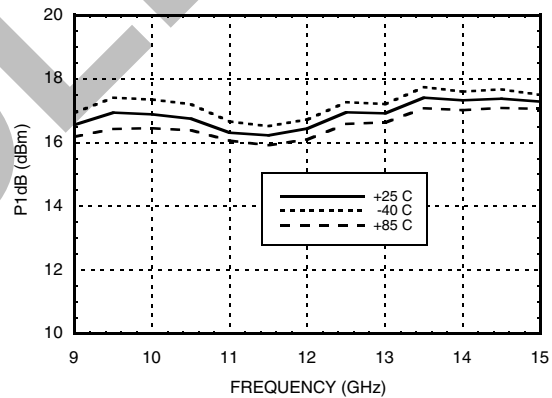

**MxN Spurious @ IF Port**

mRF	nLO				
	0	1	2	3	4
0	XX	4	28	23	N/A
1	15	0	40	62	46
2	85	70	67	78	83
3	>90	>90	>90	79	>90
4	N/A	>90	>90	>90	>90

RF = 14.45 GHz @ -10 dBm  
 LO = 13 GHz @ +17 dBm  
 All values in dBc relative to the IF power level.  
 Measured as downconverter.

**Harmonics of LO**

LO Freq. (GHz)	nLO Spur @ RF Port			
	1	2	3	4
9	34	28	46	60
10.5	37	37	50	69
12	44	45	46	60
13.5	47	46	62	N/A
15	40	56	58	N/A
16.5	34	47	51	N/A

LO = +17 dBm  
 All values in dBc below input LO level @ RF port.

\* Two-tone input power = 0 dBm each tone, 1 MHz spacing.

## GaAs MMIC DOUBLE-BALANCED HIGH IP3 MIXER, 9 - 15 GHz



### Absolute Maximum Ratings

RF / IF Input	+20 dBm
LO Drive	+27 dBm
IF DC Current	±4 mA
Storage Temperature	-65 to +150 °C
Operating Temperature	-40 to +85 °C
ESD Sensitivity (HBM)	Class 1A



ELECTROSTATIC SENSITIVE DEVICE  
OBSERVE HANDLING PRECAUTIONS

### Outline Drawing

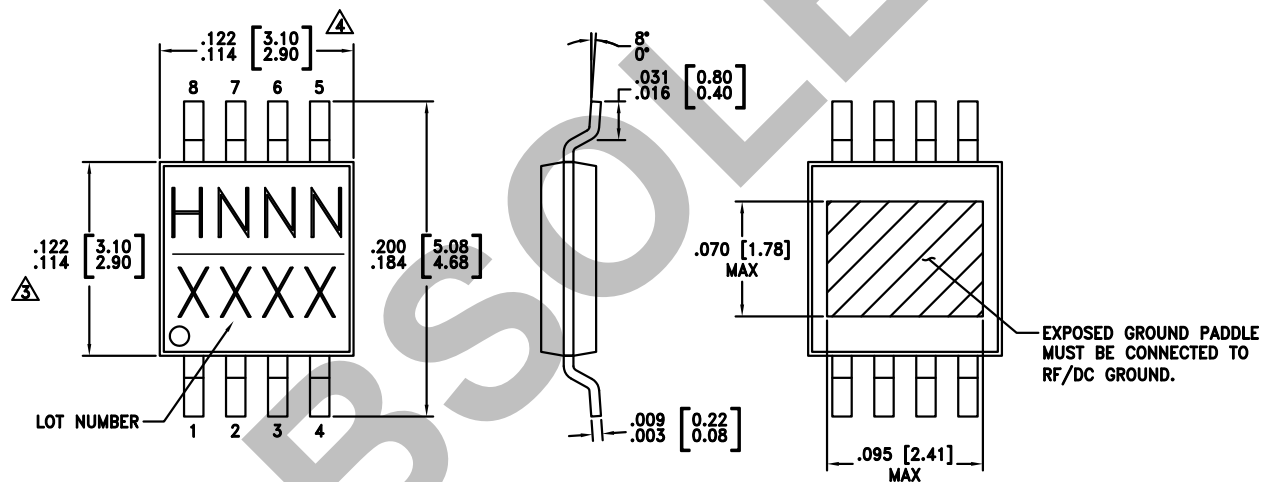

NOTES:

1. LEADFRAME MATERIAL: COPPER ALLOY
2. DIMENSIONS ARE IN INCHES [MILLIMETERS]
3. DIMENSION DOES NOT INCLUDE MOLDFLASH OF 0.15mm PER SIDE.
4. DIMENSION DOES NOT INCLUDE MOLDFLASH OF 0.25mm PER SIDE.
5. ALL GROUND LEADS AND GROUND PADDLE MUST BE SOLDERED TO PCB RF GROUND.

### Package Information

Part Number	Package Body Material	Lead Finish	MSL Rating	Package Marking <sup>[3]</sup>
HMC410AMS8G	Low Stress Injection Molded Plastic	Sn/Pb Solder	MSL1 <sup>[1]</sup>	H410A XXXX
HMC410AMS8GE	RoHS-compliant Low Stress Injection Molded Plastic	100% matte Sn	MSL1 <sup>[2]</sup>	H410A XXXX

[1] Max peak reflow temperature of 235 °C

[2] Max peak reflow temperature of 260 °C

[3] 4-Digit lot number XXXX

**GaAs MMIC DOUBLE-BALANCED  
HIGH IP3 MIXER, 9 - 15 GHz**
**Pin Descriptions**

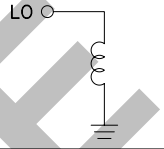
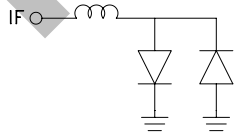
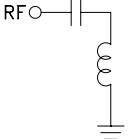
Pin Number	Function	Description	Interface Schematic
1, 8	GND	Pins and exposed ground slug must be connected to RF ground.	
2	LO	This pin is AC coupled and matched to 50 Ohms.	
3, 4, 6	N/C	The pins are not connected internally; however, all data shown herein was measured with these pins connected to RF/DC ground externally.	
5	IF	This pin is DC coupled. For applications not requiring operation to DC this port should be DC blocked externally using a series capacitor whose value has been chosen to pass the necessary IF frequency range. For operation to DC, this pin must not source/sink more than 4mA of current or die non-function and possible die failure will result.	
7	RF	This pin is DC coupled and matched to 50 Ohms.	



**Evaluation PCB**

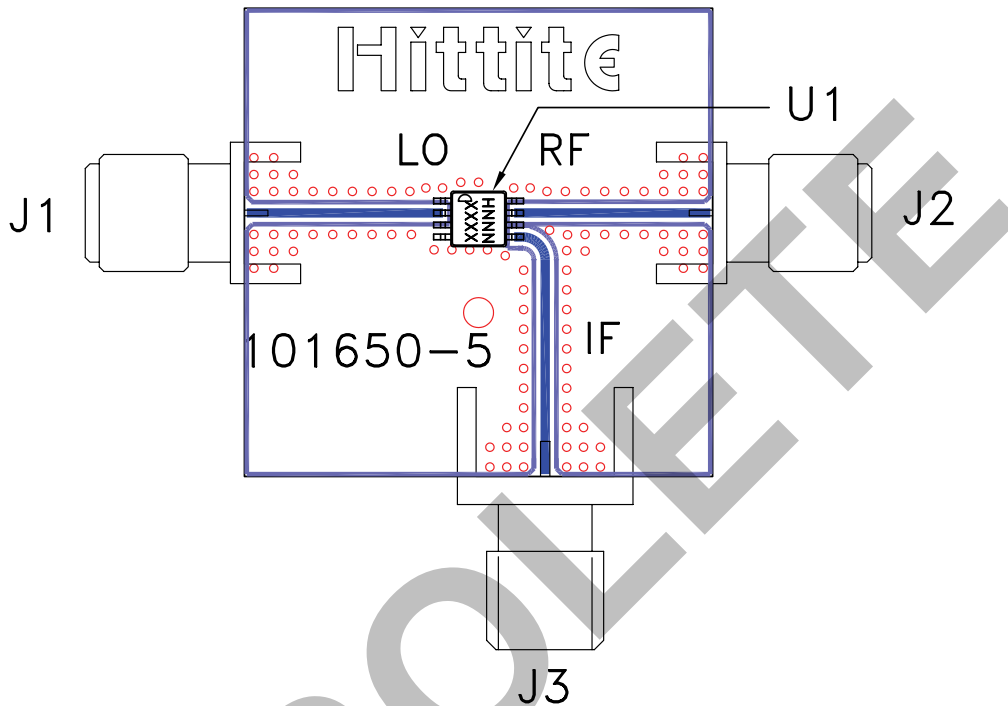

**List of Materials for Evaluation PCB 103350 [1]**

Item	Description
J1 - J2	PCB Mount SMA RF Connector, SRI
J3	PCB Mount SMA Connector, Johnson
U1	HMC410AMS8G(E) Mixer
PCB [2]	101650 Evaluation Board

[1] Reference this number when ordering complete evaluation PCB

[2] Circuit Board Material: Rogers 4350

The circuit board used in the application should use RF circuit design techniques. Signal lines should have 50 Ohm impedance while the package ground leads and exposed paddle should be connected directly to the ground plane similar to that shown. A sufficient number of via holes should be used to connect the top and bottom ground planes. The evaluation circuit board shown is available from Hittite upon request.

## Looking for pricing, stock, or lifecycle information?

Click below to explore more details on WIN SOURCE:

- ⊖ [View 103350-HMC410AMS8G on WIN SOURCE](#)
- ⊖ [Analog Devices Inc. Information](#)

## Optimize Your Supply Chain with WIN SOURCE Solutions

- ✓ Global Sourcing Solution
- ✓ Obsolete Management
- ✓ Cost Control Management
- ✓ Shortage Management
- ✓ Alternative Solution
- ✓ Excess Inventory Management