



**THE DATASHEET OF
086210007340800A+**



0.5mm Pitch

SERIES

6210/6260

0.5mmピッチ RA SMT 下接点 スライドロック

0.5mmPitch RA SMT Bottom contact Slide lock

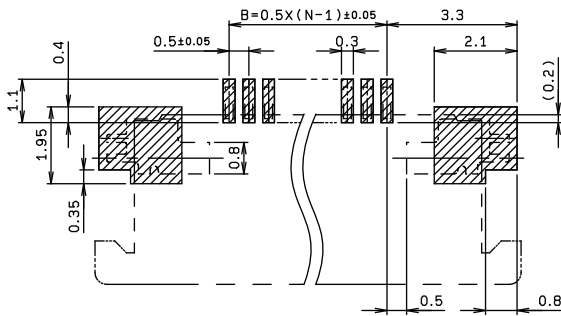
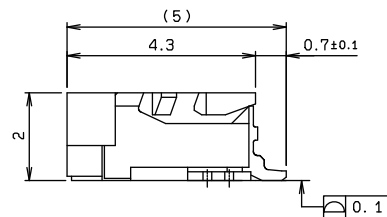
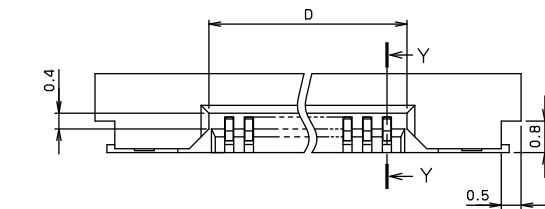
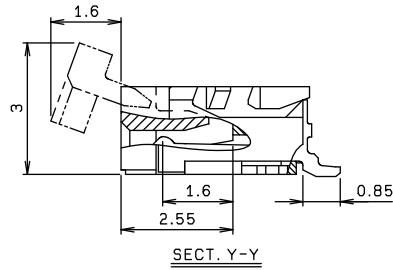
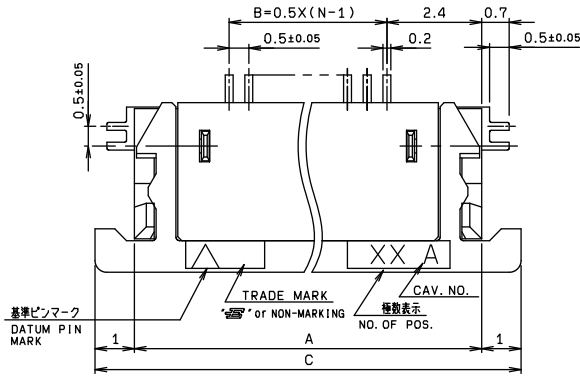

推奨基板取付寸法(コネクタ搭載側)
MOUNTING LAYOUT (CONN. MOUNTING SIDE)

極数 NO. OF POS.	A	B	C	D
5	6.8	2.0	8.8	3.1
6	7.3	2.5	9.3	3.6
7	7.8	3.0	9.8	4.1
8	8.3	3.5	10.3	4.6
9	8.8	4.0	10.8	5.1
10	9.3	4.5	11.3	5.6
11	9.8	5.0	11.8	6.1
12	10.3	5.5	12.3	6.6
13	10.8	6.0	12.8	7.1
14	11.3	6.5	13.3	7.6
15	11.8	7.0	13.8	8.1
16	12.3	7.5	14.3	8.6
17	12.8	8.0	14.8	9.1
18	13.3	8.5	15.3	9.6
19	13.8	9.0	15.8	10.1
20	14.3	9.5	16.3	10.6
21	14.8	10.0	16.8	11.1
22	15.3	10.5	17.3	11.6
23	15.8	11.0	17.8	12.1
24	16.3	11.5	18.3	12.6
25	16.8	12.0	18.8	13.1
26	17.3	12.5	19.3	13.6
27	17.8	13.0	19.8	14.1
28	18.3	13.5	20.3	14.6
29	18.8	14.0	20.8	15.1
30	19.3	14.5	21.3	15.6
33	20.8	16.0	22.8	17.1
34	21.3	16.5	23.3	17.6
36	22.3	17.5	24.3	18.6
40	24.3	19.5	26.3	20.6

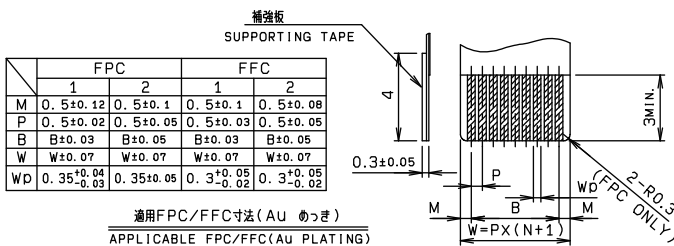

注文コード ORDERING CODE
08 6210 OXX 340 800A+

RoHS 対応品
RoHS Compliant Product
スズ銅めっき Sn-Cu Plated

極数 NUMBER OF POSITIONS

注文コード ORDERING CODE
08 6260 OXX 340 829+

RoHS 対応品
RoHS Compliant Product
金めっき Au Plated

極数 NUMBER OF POSITIONS

生産対応可能極数については、営業部にご確認願います。
Feel free to contact our sales department for available numbers of positions.

0.5mm Pitch
SERIES

6210

エンボス梱包品
Tape and Reel Package

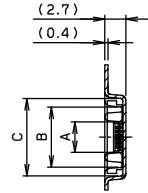
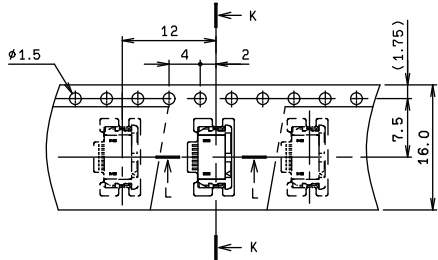

SECT. K-K

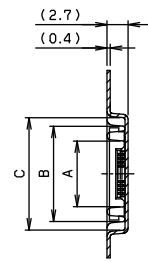
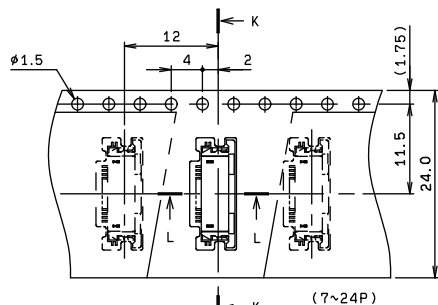

SECT. K-K
(7~24P)

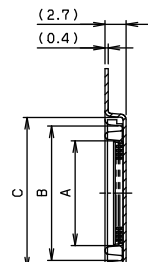
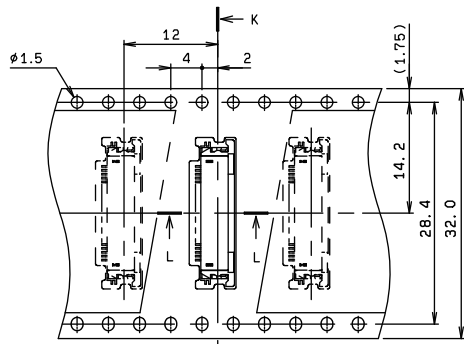

SECT. K-K
(25~30P)

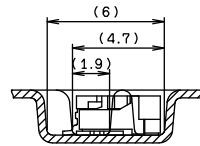

SECT. L-L

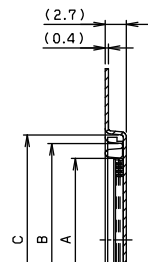
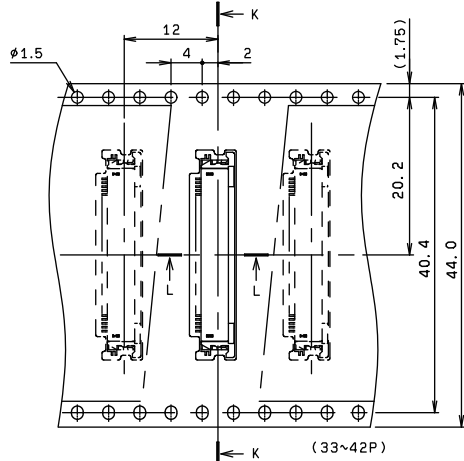

SECT. K-K
(33~42P)

極数 NO. OF POS.	A	B	C
5	3.4	7.2	9.4
6	3.9	7.7	9.9

極数 NO. OF POS.	A	B	C
7	4.4	8.2	10.4
8	4.9	8.7	10.9
9	5.4	9.2	11.4
10	5.9	9.7	11.9
11	6.4	10.2	12.4
12	6.9	10.7	12.9
13	7.4	11.2	13.4
14	7.9	11.7	13.9
15	8.4	12.2	14.4
16	8.9	12.7	14.9
17	9.4	13.2	15.4
18	9.9	13.7	15.9
19	10.4	14.2	16.4
20	10.9	14.7	16.9
21	11.4	15.2	17.4
22	11.9	15.7	17.9
23	12.4	16.2	18.4
24	12.9	16.7	18.9

極数 NO. OF POS.	A	B	C
25	13.4	17.2	19.4
26	13.9	17.7	19.9
27	14.4	18.2	20.4
28	14.9	18.7	20.9
29	15.4	19.2	21.4
30	15.9	19.7	21.9

極数 NO. OF POS.	A	B	C
33	17.4	21.2	23.4
34	17.9	21.7	23.9
35	18.4	22.2	24.4
36	18.9	22.7	24.9
38	19.9	23.7	25.9
40	20.9	24.7	26.9

注文コード ORDERING CODE

08 6210 OXX 340 800A+

RoHS 対応品

RoHS Compliant Product

スズ銅めっき Sn-Cu Plated

極数 NUMBER OF POSITIONS

生産対応可能極数については、営業部にご確認願います。

Feel free to contact our sales department for available numbers of positions.

梱包数量 2000個/リール
PACKING QUANTITY : 2000/Reel

**0.5mm Pitch
SERIES**

6260

エンボス梱包品
Tape and Reel Package

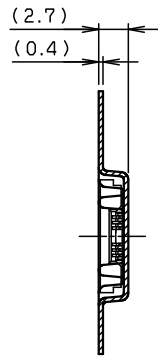
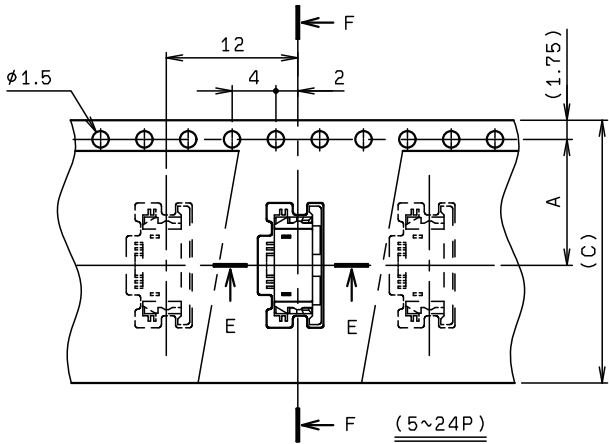

SECT. F-F
(5~24P)

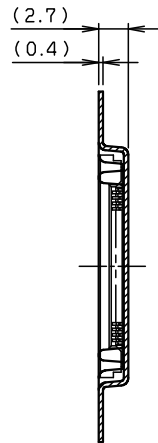
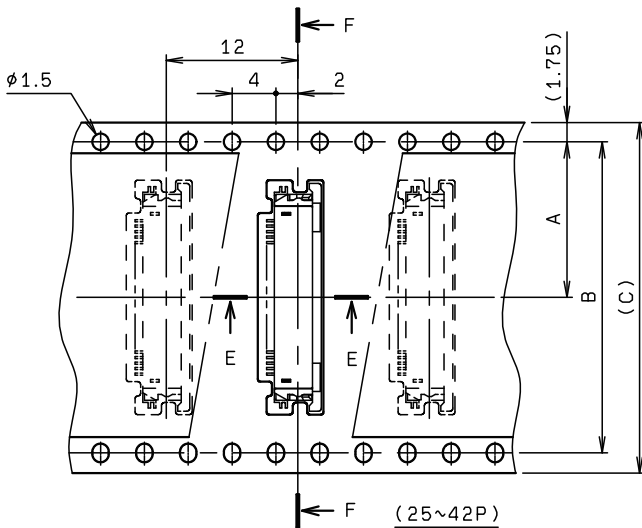

SECT. F-F
(25~42P)

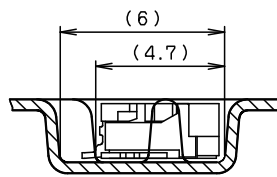

SECT. E-E

種数 NO. OF POS.	A	B	C
5	7.5	—	16.0
6	7.5	—	16.0
7	7.5	—	16.0
8	11.5	—	24.0
9	11.5	—	24.0
10	11.5	—	24.0
11	11.5	—	24.0
12	11.5	—	24.0
13	11.5	—	24.0
14	11.5	—	24.0
15	11.5	—	24.0
16	11.5	—	24.0
17	11.5	—	24.0
18	11.5	—	24.0
19	11.5	—	24.0
20	11.5	—	24.0
21	11.5	—	24.0
22	11.5	—	24.0
23	11.5	—	24.0
24	11.5	—	24.0
25	14.2	28.4	32.0
26	14.2	28.4	32.0
27	14.2	28.4	32.0
28	14.2	28.4	32.0
29	14.2	28.4	32.0
30	14.2	28.4	32.0
31	20.2	40.5	44.0
32	20.2	40.5	44.0
33	20.2	40.5	44.0
34	20.2	40.5	44.0
35	20.2	40.5	44.0
36	20.2	40.5	44.0
37	20.2	40.5	44.0
38	20.2	40.5	44.0
39	20.2	40.5	44.0
40	20.2	40.5	44.0
42	20.2	40.5	44.0

注文コード ORDERING CODE

08 6260 OXX 340 829+

RoHS 対応品

RoHS Compliant Product

金めっき Au Plated

極数 NUMBER OF POSITIONS

生産対応可能極数については、営業部にご確認願います。

Feel free to contact our sales department for available numbers of positions.

梱包数量 2000個/リール
PACKING QUANTITY : 2000/Reel

Looking for pricing, stock, or lifecycle information?

Click below to explore more details on WIN SOURCE:

- [View 086210007340800A+ on WIN SOURCE](#)
- [AVX Corp/Kyocera Corp Information](#)

Optimize Your Supply Chain with WIN SOURCE Solutions

- ✓ Global Sourcing Solution
- ✓ Obsolete Management
- ✓ Cost Control Management
- ✓ Shortage Management
- ✓ Alternative Solution
- ✓ Excess Inventory Management