



THE DATASHEET OF
0697W2500-02



Type 0697W

Time Lag Radial Lead Micro Fuse Series

HF  0697W Series

RoHS Compliant

Description

Sub-miniature, time lag type, 350VAC, 72VDC rated fuses designed, approved and complied with IEC 60127-3, standard sheet 4.

Features

- Time lag (350 VAC, 72 VDC)
- Meet IEC standard 60127-3, sheet 4
- Wide operating temperature range
- Bulk and Tape & Reel packing available
- AEC-Q Compliant
- Full compliance with EU Directive 2011/65/EU and amending directive 2015/863
- Halogen Free and Lead Free
- Meets Bel automotive qualification*
- * - Largely based on internal AEC-Q test plan

Applications

Provide individual protection for components or internal circuits.

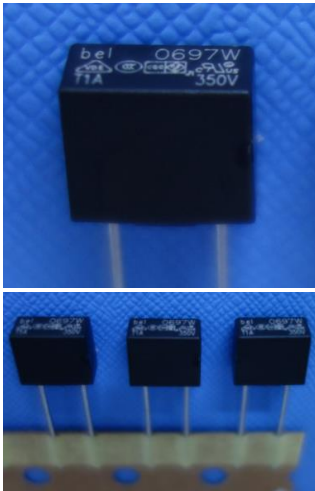

- Power supplies
- Battery chargers
- Consumer electronics
- Adapter
- Industrial controllers

LEAD FREE = 
 HALOGEN FREE = 



AEC-Q Compliant





Physical Specifications

Materials	Base and Cover : Black thermoplastic, UL 94-V0
	Pins : 100% Matte Tin Plated Copper
Marking	On Fuse :
	"bel", "0697W", "T", "Current Rating", "350V" & "Appropriate Safety Logos"
	On Label :
"bel", "0697W", "T", "Current Rating", "Voltage Rating", "Interrupting Rating", "Appropriate Safety Logos" and "  ", "  "(China RoHS compliant).	

Electrical Characteristics (IEC-127-3 STANDARD SHEET 4)

Rated Current	1.5In		2.1In		2.75In		4In		10In	
	Min	Max	Min	Max	Min	Max	Min	Max	Min	Max
1A to 6.3A inclusive	1 hour	2 min.	400 ms	10 sec	150 ms	3 sec	20 ms	150 ms		

Safety Agency Approvals

Safety Agency	Safety Agency Certificate	Ampere Rating/ Voltage Rating	Ampere Range / Volt @ I.R. ability*
	40039412	1A-6.3A/350Vac 72Vdc	1A-1.6A/350V ac @ 50A 2A-6.3A/350V ac @ 65A 1A-6.3A/250V ac @ 65A 1A-6.3A/72V dc @ 100A
	PSE21021837 PSE21021839		1A-2A/350V ac @ 50A 2.5A-6.3A/350V ac @ 100A 1A-6.3A/72V dc @ 100A
	E20624		1A-2A/350V ac @ 65A 2.5A-6.3A/350V ac @ 100A 1A-1.6A/72V dc @ 65A 2A-6.3A/72V dc @ 100A
	Self-declaration No: 2020970207000020		1A-2A/250V ac @ 50A 1A-2A/350V ac @ 50A 2.5A-6.3A/250V ac @ 100A 2.5A-6.3A/350V ac @ 100A 1A-6.3A/72V dc @ 100A





*I.R.= Interrupting Rating = Short Circuit Rating(Amps)

Environmental Specifications

Shock Resistance	MIL-STD-202G, Method 213B, Test Condition 1 (100 G's peak for 6 milliseconds; Sawtooth waveform)
Vibration Resistance	MIL-STD-202G, Method 201A (10-55 Hz X 3 axis / no load).
Salt Spray Resistance	MIL-STD-202G, Method 101E, Test Condition B (48 hrs.).
Solderability	MIL-STD-202G, Method 208H
Resistance to solder Heat	MIL-STD-202G, Method 210F, Test Condition C. Top Side. (260°C, 20 sec)
Moisture Resistance	MIL-STD-202G, Method 202G, Method 106G
Operating Temperature	-55°C to +125°C

High temperature storage	MIL-STD-202 Method 108
Temperature cycling	JESD22 Method JA-104, Test Condition B
Biased humidity	MIL-STD-202 Method 103, 85C/85% RH with 10% operating power for 1000 hrs.
Operational life	MIL-STD-202 Method 108, Test Condition D
Resistance to solvents	MIL-STD-202 Method 215
Mechanical shock	MIL-STD-202 Method 213, Test Condition C
Vibration	MIL-STD-202 Method 204
Resistance to soldering heat	MIL-STD-202 Method 210, Test condition B
Thermal shock	MIL-STD-202 Method 107
Solderability	J-STD-002
Board flex(SMD)	AEC-Q200-005
Terminal strength	AEC-Q200-006
Electrical characterization	3 temperature electrical

Electrical Specifications

Part Number	Ampere Rating	Typical Cold Resistance (ohms)	Volt-drop @100% In (Volt) max.	Voltage and Interrupting Ratings	Nominal Melting I ² T <10 mSec (A ² Sec)	Nominal Melting I ² T @10 In (A ² Sec)	Maximum Power Dissipation (W)	Agency Approvals			
											
0697W1000-XX	1A	0.085	0.115	See Table of Safety Approvals on Page 1 for Voltage and associated Interrupting Ratings	5.8	7.6	0.44	Y	Y	Y	Y
0697W1250-XX	1.25A	0.064	0.110		9	12	0.56	Y	Y	Y	Y
0697W1600-XX	1.6A	0.045	0.100		15	17	0.60	Y	Y	Y	Y
0697W2000-XX	2A	0.032	0.090		26	30	0.63	Y	Y	Y	Y
0697W2500-XX	2.5A	0.025	0.087		45	51	0.70	Y	Y	Y	Y
0697W3150-XX	3.15A	0.018	0.083		66	75	0.88	Y	Y	Y	Y
0697W4000-XX	4A	0.014	0.080		98	107	0.98	Y	Y	Y	Y
0697W5000-XX	5A	0.009	0.075		94	108	0.75	Y	Y	Y	Y
0697W6300-XX	6.3A	0.007	0.075		101	109	0.98	Y	Y	Y	Y

Consult manufacturer for other ratings

XX - Packaging code (see "ordering information")



Specifications subject to change without notice

Bel Fuse Inc.
206 Van Vorst Street
Jersey City, NJ 07302 USA

+1 201.432.0463
Bel.US.CS@belf.com
belfuse.com/circuit-protection

Temperature Derating Curve

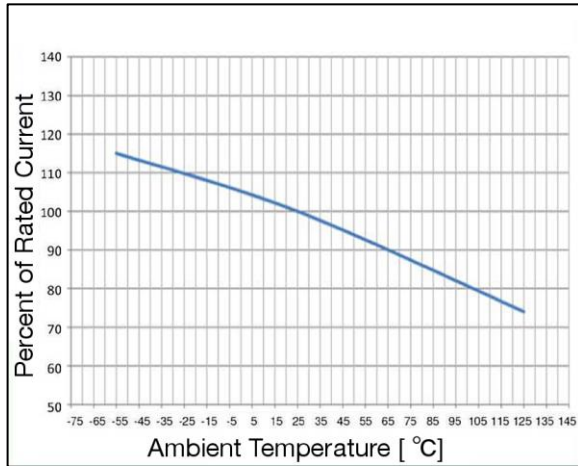

Average Time Current Curve

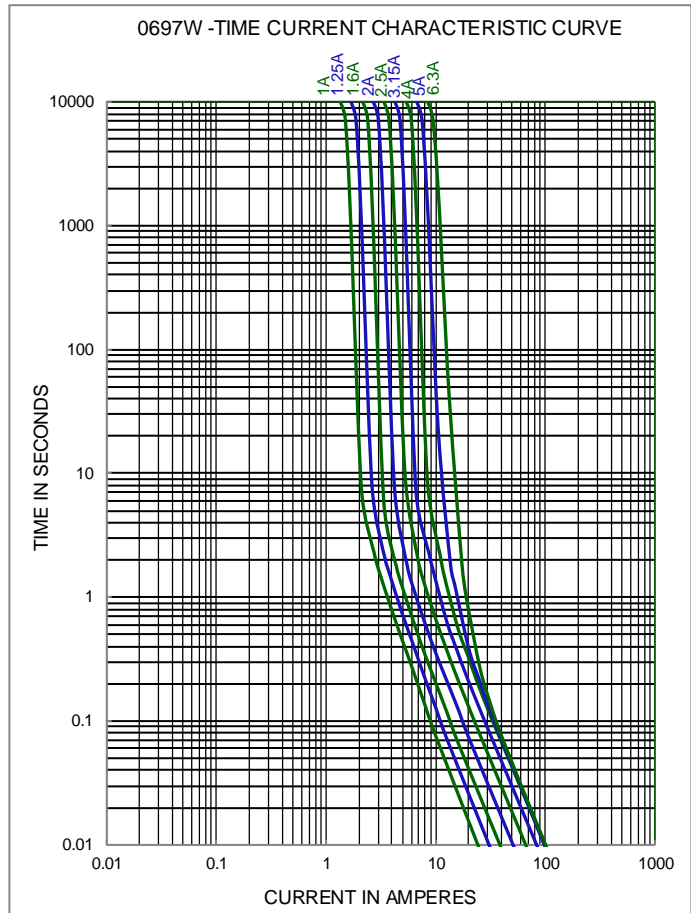

Soldering Parameters

Lead-free Wave Soldering Profile	
Wave Soldering Parameter	
Average ramp-up rate	200°C / second
Heating rate during preheat	typical 1 - 2°C / second Max 4°C / second
Final preheat temperature	within 125°C of soldering temperature
Peak temperature T _p	260°C
Time within +0°C / -5°C of actual peak temperature	10 seconds
Ramp-down rate	5°C / second max.

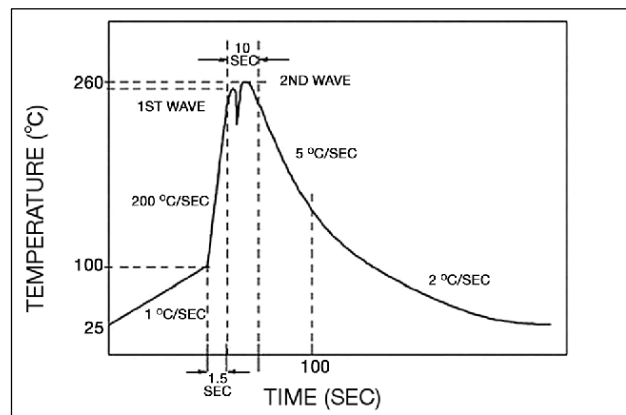

Fuse FGNO Explanation

0697 W [XXXX] X XX

0697W=0697W; [XXXX]=Ampere Rating; XX=See Ordering Information as below

Fraction	Decimal	Amps	Bel FGNO[XXXX]
	1.0	1	1000
1-1/4	1.25	1.25	1250
	1.60	1.6	1600
	2.0	2	2000
2-1/2	2.5	2.5	2500
	3.15	3.15	3150
	4.0	4	4000
	5.0	5	5000
	6.3	6.3	6300

Mechanical Dimensions

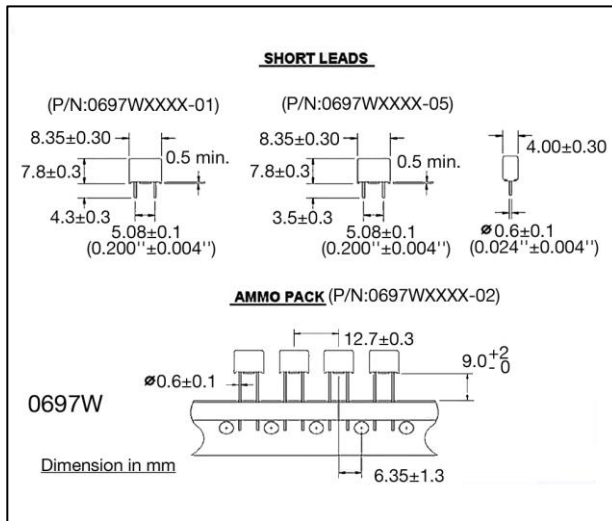

Ordering Information

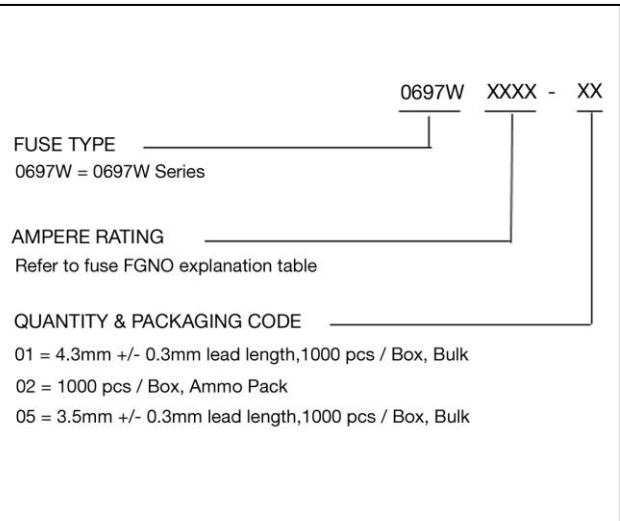

Packaging

Packaging Option	Packaging Specification	Quantity	Packaging Code
Bulk / bag, 1000 / box	N/A	1000	01 , 05
12.7 mm pitch, On Tape / box	IEC-286-2	1000	02

Looking for pricing, stock, or lifecycle information?

Click below to explore more details on WIN SOURCE:

 [View 0697W2500-02 on WIN SOURCE](#)

 [Bel Fuse Inc. Information](#)

Optimize Your Supply Chain with WIN SOURCE Solutions

-  Global Sourcing Solution
-  Obsolete Management
-  Cost Control Management
-  Shortage Management
-  Alternative Solution
-  Excess Inventory Management