



THE DATASHEET OF
046227012100800+



1.0mm Pitch
SERIES

6227

1.0mmピッチ NON-ZIF RA SMT 両面接点
1.0mmPitch LIF RA SMT Dual-sided contact

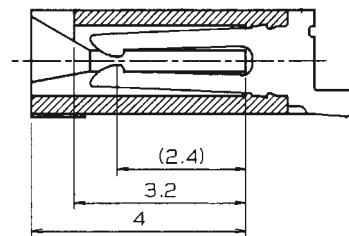
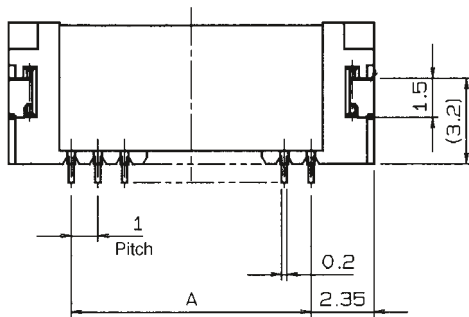
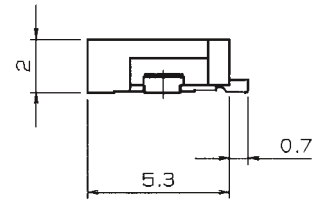
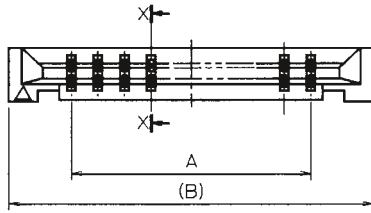

SECT. X-X

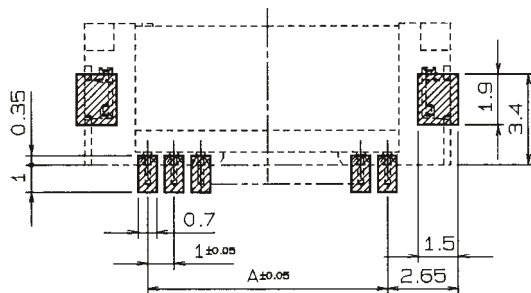

基板取付寸法 (コネクタ搭載面側)
MOUNTING LAYOUT (CONN. MOUNTING SIDE)

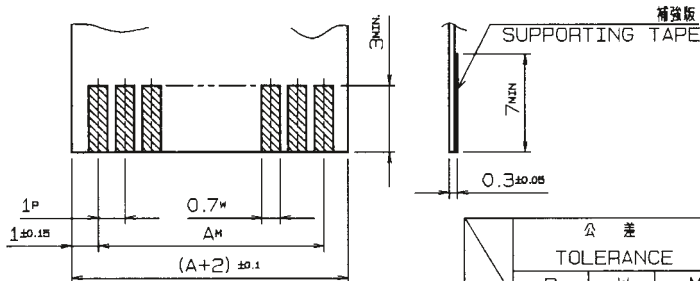

適用FPC/FFC
APPLICABLE FPC/FFC

	公差 TOLERANCE		
	P	W	M
FPC	±0.02	+0.07 -0.05	±0.05
FFC	±0.05	±0.03	±0.1

寸法表 DIMENSION		
極数 NO. OF POS.	A	B
4	3	7.7
5	4	8.7
6	5	9.7
7	6	10.7
8	7	11.7
9	8	12.7
10	9	13.7
11	10	14.7
12	11	15.7
13	12	16.7
14	13	17.7
15	14	18.7
16	15	19.7
17	16	20.7
18	17	21.7
19	18	22.7
20	19	23.7

注文コード ORDERING CODE

XX 6227 OXX 100 800+

RoHS 対応品

RoHS Compliant Product

00: トレー梱包

TRAY PACKAGE 極数 NUMBER OF POSITIONS

スズ銅めっき Sn-Cu Plated

エンボス梱包品: 04 6227 OXX 100 800+

Tape & Reel Package: 04 6227 OXX 100 800+

生産対応可能極数については、営業部にご確認願います。

Feel free to contact our sales department for available numbers of positions.

1.0mm Pitch
SERIES

6227

エンボス梱包品
Tape and Reel Package

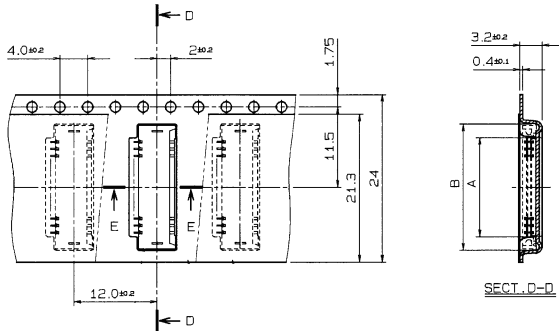

型番 ASSEMBLY NUMBER	極数 NO. OF POS.	A	B
04 6227 004 100 XXX +	4	4.2	8.1
↑ 005	↑ 5	5.2	9.1
006	6	6.2	10.1
007	7	7.2	11.1
008	8	8.2	12.1
009	9	9.2	13.1
↓ 010	↓ 10	10.2	14.1
04 6227 011 100 XXX +	11	11.2	15.1

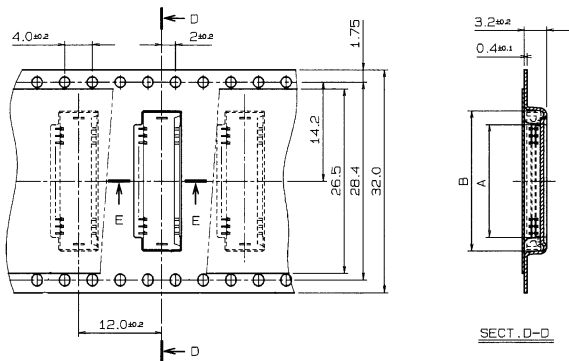

型番 ASSEMBLY NUMBER	極数 NO. OF POS.	A	B
04 6227 012 100 XXX +	12	12.2	16.1
↑ 013	↑ 13	13.2	17.1
014	14	14.2	18.1
015	15	15.2	19.1
016	16	16.2	20.1
↓ 017	↓ 17	17.2	21.1
04 6227 018 100 XXX +	18	18.2	22.1

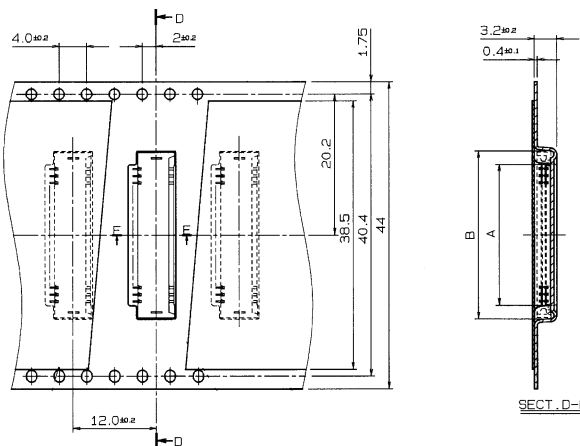

型番 ASSEMBLY NUMBER	極数 NO. OF POS.	A	B
04 6227 019 100 XXX +	19	19.2	23.1
04 6227 020 100 XXX +	20	20.2	24.1

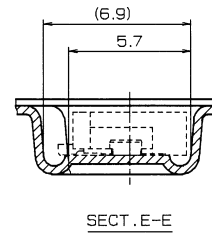

注文コード ORDERING CODE
04 6227 OXX 100 XXX+

RoHS 対応品
RoHS Compliant Product

極数 NUMBER OF POSITIONS

800+ : スズ銅めっき Sn-Cu Plated
829+ : 金めっき Au Plated

トレー梱包品 : 00 6227 OXX 100 XXX+
TRAY PACKAGE : 00 6227 OXX 100 XXX+

生産対応可能極数については、営業部にご確認願います。

Feel free to contact our sales department for available numbers of positions.

梱包数量 1000個/リール
PACKING QUANTITY 1000/Reel

Looking for pricing, stock, or lifecycle information?

Click below to explore more details on WIN SOURCE:

-  [View 046227012100800+ on WIN SOURCE](#)
-  [AVX Corp/Kyocera Corp](#) Information

Optimize Your Supply Chain with WIN SOURCE Solutions

-  Global Sourcing Solution
-  Obsolete Management
-  Cost Control Management
-  Shortage Management
-  Alternative Solution
-  Excess Inventory Management