

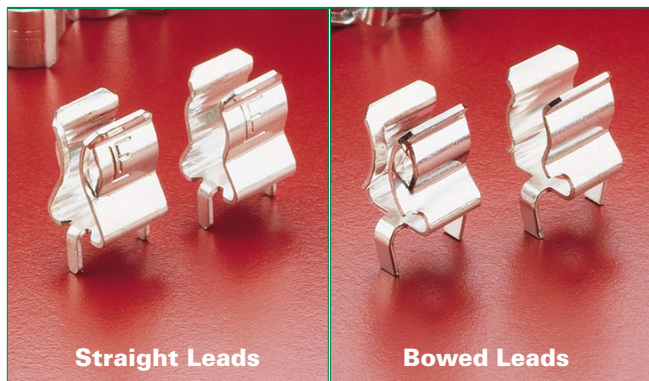



THE DATASHEET OF
01020079Z



102/122 Series Circuit Board Mount Fuse Clips for 1/4" Diameter Fuses



Agency Approval		
Agency	Agency File Number	
	102 Series	122 Series
	E14721	

Additional Information



**Datasheet
102 Series**



**Resources
102 Series**



**Samples
102 Series**



**Datasheet
122 Series**



**Resources
122 Series**



**Samples
122 Series**

Product Characteristics

	102 Series	122 Series
Compatible Fuse Size	1/4" Diameter Fuses 312, 313, 314, 326, 505, 506, 508 Series	
Current Level	15 amperes max	30 amperes max

Product Dimensions

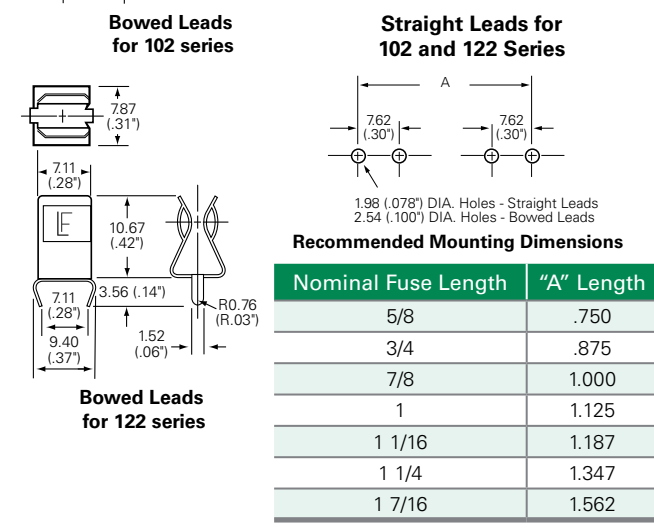
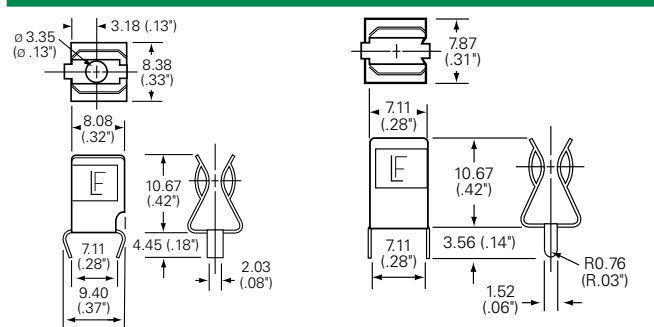

Ordering Information

Ordering PN *	Catalog No.	Clip Material	Plating	Style	Packaging Available
Traditional Clips					
01020071	102 071	Spring Brass	Tin-plated	Ear	Z
01020074	102 074	Spring Brass	Tin-plated	Earless	Z
01020076	102 076	Spring Brass	Tin-plated	Ear	Z
01220055	122 055	Copper-Nickel Alloy	Tin-plated	Ear	Z
01220083	122 083	Beryllium Copper	Silver-plated	Ear	Z
01220087	122 087	Beryllium Copper	Silver-plated	Earless	Z
01220088	122 088	Beryllium Copper	Tin-plated	Ear	Z & ZR
01220093	122 093	Beryllium Copper	Tin-plated	Earless	Z
Bowed Tab Clips					
01020078	102 078	Spring Brass	Tin-plated	Earless	H & Z
01020079	102 079	Spring Brass	Tin-plated	Ear	Z
01220055Z-1	122 055	Copper-Nickel Alloy	Tin-plated	Ear	-
01220088Z-1	122 088	Beryllium Copper	Tin-plated	Ear	-

***Add Suffix to the Ordering PN for Packaging:**

"H" = Std. package 100 pcs per pack

"Z" = For bulk package

"ZR" = Tape and reel package, 300pcs

Looking for pricing, stock, or lifecycle information?

Click below to explore more details on WIN SOURCE:

 [View 01020079Z on WIN SOURCE](#)

 [Littelfuse Inc. Information](#)

Optimize Your Supply Chain with WIN SOURCE Solutions

-  Global Sourcing Solution
-  Obsolete Management
-  Cost Control Management
-  Shortage Management
-  Alternative Solution
-  Excess Inventory Management