



**THE DATASHEET OF  
MTA18ASF1G72PDZ-2G1A1**



# DDR4 SDRAM RDIMM

## MTA18ASF1G72PDZ – 8GB

### Features

- DDR4 functionality and operations supported as defined in the component data sheet
- 288-pin, registered dual in-line memory module (RDIMM)
- Fast data transfer rates: PC4-2400 and PC4-2133
- 8GB (1 Gig x 72)
- $V_{DD} = 1.20V$  (NOM)
- $V_{PP} = 2.5V$  (NOM)
- $V_{DDSPD} = 2.5V$  (NOM)
- Supports ECC error detection and correction
- Nominal and dynamic on-die termination (ODT) for data, strobe, and mask signals
- Low-power auto self refresh (LPASR)
- Data bus inversion (DBI) for data bus
- On-die  $V_{REFDQ}$  generation and calibration
- Dual-rank
- On-board I<sup>2</sup>C temperature sensor with integrated serial presence-detect (SPD) EEPROM
- 16 internal banks; 4 groups of 4 banks each
- Fixed burst chop (BC) of 4 and burst length (BL) of 8 via the mode register set (MRS)
- Selectable BC4 or BL8 on-the-fly (OTF)
- Gold edge contacts
- Halogen-free
- Fly-by topology
- Terminated control, command, and address bus

**Figure 1: 288-Pin RDIMM (MO-309, R/C-E)**

Module height: 31.25mm (1.23in)

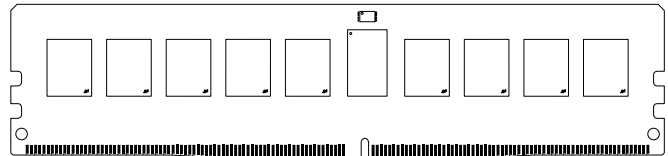
**Figure 2: 288-Pin RDIMM (MO-309, R/C-E1)**

Module height: 31.25mm (1.23in)

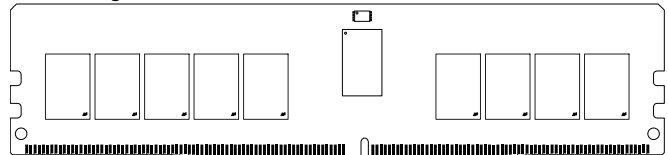

### Options

- Operating temperature
  - Commercial ( $0^{\circ}C \leq T_{OPER} \leq 95^{\circ}C$ )
- Package
  - 288-pin DIMM (halogen-free)
- Frequency/CAS latency
  - 0.83ns @ CL = 17 (DDR4-2400)
  - 0.93ns @ CL = 15 (DDR4-2133)

### Marking

None  
Z  
-2G3  
-2G1

**Table 1: Key Timing Parameters**

Speed Grade	Industry Nomenclature	Data Rate (MT/s)											$t_{RCD}$ (ns)	$t_{RP}$ (ns)	$t_{RC}$ (ns)
		CL = 20, CL = 19	CL = 18	CL = 17	CL = 16	CL = 15	CL = 14	CL = 13	CL = 12	CL = 11	CL = 10	CL = 9			
-2G6	PC4-2666	2666	2666	2400	2133	2133	1866	1866	1600	–	1333	–	14.16	14.16	46.16
-2G4	PC4-2400	–	2400	2400	2400	2133	1866	1866	1600	1600	–	1333	13.32	13.32	45.32
-2G3	PC4-2400	–	2400	2400	2133	2133	1866	1866	1600	1600	1333	–	14.16	14.16	46.16
-2G1	PC4-2133	–	–	–	2133	2133	1866	1866	1600	1600	–	1333	13.5	13.5	46.5



**Table 2: Addressing**

Parameter	8GB
Row address	32K A[14:0]
Column address	1K A[9:0]
Device bank group address	4 BG[1:0]
Device bank address per group	4 BA[1:0]
Device configuration	4Gb (512 Meg x 8), 16 banks
Module rank address	2 CS_n[1:0]

**Table 3: Part Numbers and Timing Parameters – 8GB Modules**

Base device: MT40A512M,<sup>1</sup> 4Gb DDR4 SDRAM

Part Number <sup>2</sup>	Module Density	Configuration	Module Bandwidth	Memory Clock/ Data Rate	Clock Cycles (CL- <sup>t</sup> RCD- <sup>t</sup> RP)
MTA18ASF1G72PDZ-2G3__	8GB	1 Gig x 72	19.2 GB/s	0.83ns/2400 MT/s	17-17-17
MTA18ASF1G72PDZ-2G1__	8GB	1 Gig x 72	17.0 GB/s	0.93ns/2133 MT/s	15-15-15

- Notes:
1. The data sheet for the base device can be found on [micron.com](http://micron.com).
  2. All part numbers end with a two-place code (not shown) that designates component and PCB revisions. Consult factory for current revision codes. Example: MTA18ASF1G72PDZ-2G3B1.



## Pin Assignments

The pin assignment table below is a comprehensive list of all possible pin assignments for DDR4 RDIMM modules. See the Functional Block Diagram for pins specific to this module.

**Table 4: Pin Assignments**

288-Pin DDR4 RDIMM Front								288-Pin DDR4 RDIMM Back							
Pin	Symbol	Pin	Symbol	Pin	Symbol	Pin	Symbol	Pin	Symbol	Pin	Symbol	Pin	Symbol	Pin	Symbol
1	NC	37	V <sub>SS</sub>	73	V <sub>DD</sub>	109	V <sub>SS</sub>	145	NC	181	DQ29	217	V <sub>DD</sub>	253	DQ41
2	V <sub>SS</sub>	38	DQ24	74	CK0_t	110	DQS14_t/ TDQS14_t	146	V <sub>REFCA</sub>	182	V <sub>SS</sub>	218	CK1_t	254	V <sub>SS</sub>
3	DQ4	39	V <sub>SS</sub>	75	CK0_c	111	DQS14_c/ TDQS14_c	147	V <sub>SS</sub>	183	DQ25	219	CK1_c	255	DQS5_c
4	V <sub>SS</sub>	40	DQS12_t/ TDQS12_t	76	V <sub>DD</sub>	112	V <sub>SS</sub>	148	DQ5	184	V <sub>SS</sub>	220	V <sub>DD</sub>	256	DQS5_t
5	DQ0	41	DQS12_c/ TDQS12_c	77	V <sub>TT</sub>	113	DQ46	149	V <sub>SS</sub>	185	DQS3_c	221	V <sub>TT</sub>	257	V <sub>SS</sub>
6	V <sub>SS</sub>	42	V <sub>SS</sub>	78	EVENT_n	114	V <sub>SS</sub>	150	DQ1	186	DQS3_t	222	PARITY	258	DQ47
7	DQS9_t/ TDQS9_t	43	DQ30	79	A0	115	DQ42	151	V <sub>SS</sub>	187	V <sub>SS</sub>	223	V <sub>DD</sub>	259	V <sub>SS</sub>
8	DQS09_c/ TDQS9_c	44	V <sub>SS</sub>	80	V <sub>DD</sub>	116	V <sub>SS</sub>	152	DQS0_c	188	DQ31	224	BA1	260	DQ43
9	V <sub>SS</sub>	45	DQ26	81	BA0	117	DQ52	153	DQS0_t	189	V <sub>SS</sub>	225	A10/ AP	261	V <sub>SS</sub>
10	DQ6	46	V <sub>SS</sub>	82	RAS_n/ A16	118	V <sub>SS</sub>	154	V <sub>SS</sub>	190	DQ27	226	V <sub>DD</sub>	262	DQ53
11	V <sub>SS</sub>	47	CB4	83	V <sub>DD</sub>	119	DQ48	155	DQ7	191	V <sub>SS</sub>	227	NC	263	V <sub>SS</sub>
12	DQ2	48	V <sub>SS</sub>	84	CS0_n	120	V <sub>SS</sub>	156	V <sub>SS</sub>	192	CB5	228	WE_n/ A14	264	DQ49
13	V <sub>SS</sub>	49	CB0	85	V <sub>DD</sub>	121	DQS15_t/ TDQS15_t	157	DQ3	193	V <sub>SS</sub>	229	V <sub>DD</sub>	265	V <sub>SS</sub>
14	DQ12	50	V <sub>SS</sub>	86	CAS_n/ A15	122	DQS15_c/ TDQS15_c	158	V <sub>SS</sub>	194	CB1	230	NC	266	DQS6_c
15	V <sub>SS</sub>	51	DQS17_t/ TDQS17_t	87	ODT0	123	V <sub>SS</sub>	159	DQ13	195	V <sub>SS</sub>	231	V <sub>DD</sub>	267	DQS6_t
16	DQ8	52	DQS17_c/ TDQS17_c	88	V <sub>DD</sub>	124	DQ54	160	V <sub>SS</sub>	196	DQS8_c	232	A13	268	V <sub>SS</sub>
17	V <sub>SS</sub>	53	V <sub>SS</sub>	89	CS1_n/ NC	125	V <sub>SS</sub>	161	DQ9	197	DQS8_t	233	V <sub>DD</sub>	269	DQ55
18	DQS10_t/ TDQS10_t	54	CB6	90	V <sub>DD</sub>	126	DQ50	162	V <sub>SS</sub>	198	V <sub>SS</sub>	234	A17	270	V <sub>SS</sub>
19	DQS10_c/ TDQS10_c	55	V <sub>SS</sub>	91	ODT1/ NC	127	V <sub>SS</sub>	163	DQS1_c	199	CB7	235	NC/ C2	271	DQ51
20	V <sub>SS</sub>	56	CB2	92	V <sub>DD</sub>	128	DQ60	164	DQS1_t	200	V <sub>SS</sub>	236	V <sub>DD</sub>	272	V <sub>SS</sub>
21	DQ14	57	V <sub>SS</sub>	93	CS2_n/ C0	129	V <sub>SS</sub>	165	V <sub>SS</sub>	201	CB3	237	CS3_n/ C1, NC	273	DQ61
22	V <sub>SS</sub>	58	RESET_n	94	V <sub>SS</sub>	130	DQ56	166	DQ15	202	V <sub>SS</sub>	238	SA2	274	V <sub>SS</sub>
23	DQ10	59	V <sub>DD</sub>	95	DQ36	131	V <sub>SS</sub>	167	V <sub>SS</sub>	203	CKE1/ NC	239	V <sub>SS</sub>	275	DQ57
24	V <sub>SS</sub>	60	CKE0	96	V <sub>SS</sub>	132	DQS16_t/ TDQS16_t	168	DQ11	204	V <sub>DD</sub>	240	DQ37	276	V <sub>SS</sub>



## 8GB (x72, ECC, DR) 288-Pin DDR4 RDIMM Pin Assignments

**Table 4: Pin Assignments (Continued)**

288-Pin DDR4 RDIMM Front								288-Pin DDR4 RDIMM Back							
Pin	Symbol	Pin	Symbol	Pin	Symbol	Pin	Symbol	Pin	Symbol	Pin	Symbol	Pin	Symbol	Pin	Symbol
25	DQ20	61	V <sub>DD</sub>	97	DQ32	133	DQS16_c/ TDQS16_c	169	V <sub>SS</sub>	205	NC	241	V <sub>SS</sub>	277	DQS7_c
26	V <sub>SS</sub>	62	ACT_n	98	V <sub>SS</sub>	134	V <sub>SS</sub>	170	DQ21	206	V <sub>DD</sub>	242	DQ33	278	DQS7_t
27	DQ16	63	BG0	99	DQS13_t/ TDQ13_t	135	DQ62	171	V <sub>SS</sub>	207	BG1	243	V <sub>SS</sub>	279	V <sub>SS</sub>
28	V <sub>SS</sub>	64	V <sub>DD</sub>	100	DQS13_c/ TDQS13_c	136	V <sub>SS</sub>	172	DQ17	208	ALERT_n	244	DQS4_c	280	DQ63
29	DQS11_t/ TDQS11_t	65	A12/BC_n	101	V <sub>SS</sub>	137	DQ58	173	V <sub>SS</sub>	209	V <sub>DD</sub>	245	DQS4_t	281	V <sub>SS</sub>
30	DQS11_c/ TDQS11_c	66	A9	102	DQ38	138	V <sub>SS</sub>	174	DQS2_c	210	A11	246	V <sub>SS</sub>	282	DQ59
31	V <sub>SS</sub>	67	V <sub>DD</sub>	103	V <sub>SS</sub>	139	SA0	175	DQS2_t	211	A7	247	DQ39	283	V <sub>SS</sub>
32	DQ22	68	A8	104	DQ34	140	SA1	176	V <sub>SS</sub>	212	V <sub>DD</sub>	248	V <sub>SS</sub>	284	V <sub>DDSPD</sub>
33	V <sub>SS</sub>	69	A6	105	V <sub>SS</sub>	141	SCL	177	DQ23	213	A5	249	DQ35	285	SDA
34	DQ18	70	V <sub>DD</sub>	106	DQ44	142	V <sub>PP</sub>	178	V <sub>SS</sub>	214	A4	250	V <sub>SS</sub>	286	V <sub>PP</sub>
35	V <sub>SS</sub>	71	A3	107	V <sub>SS</sub>	143	V <sub>PP</sub>	179	DQ19	215	V <sub>DD</sub>	251	DQ45	287	V <sub>PP</sub>
36	DQ28	72	A1	108	DQ40	144	NC	180	V <sub>SS</sub>	216	A2	252	V <sub>SS</sub>	288	V <sub>PP</sub>



## DQ Map

Table 5: Component-to-Module DQ Map

Component Reference Number	Component DQ	Module DQ	Module Pin Number	Component Reference Number	Component DQ	Module DQ	Module Pin Number
U2	0	3	157	U3	0	11	168
	1	0	5		1	8	16
	2	2	12		2	10	23
	3	1	150		3	9	161
	4	7	155		4	15	166
	5	4	3		5	12	14
	6	6	10		6	14	21
	7	5	148		7	13	159
U4	0	19	179	U5	0	27	190
	1	16	27		1	24	38
	2	18	34		2	26	45
	3	17	172		3	25	183
	4	23	177		4	31	188
	5	20	25		5	28	36
	6	22	32		6	30	43
	7	21	170		7	29	181
U6	0	CB3	201	U8	0	35	249
	1	CB0	49		1	32	97
	2	CB2	56		2	34	104
	3	CB1	194		3	33	242
	4	CB7	199		4	39	247
	5	CB4	47		5	36	95
	6	CB6	54		6	38	102
	7	CB5	192		7	37	240
U9	0	43	260	U10	0	51	271
	1	40	108		1	48	119
	2	42	115		2	50	126
	3	41	253		3	49	264
	4	47	258		4	55	269
	5	44	106		5	52	117
	6	46	113		6	54	124
	7	45	251		7	53	262
U11	0	59	282	U12	0	56	130
	1	56	130		1	59	282
	2	58	137		2	57	275
	3	57	275		3	58	137
	4	63	280		4	60	128
	5	60	128		5	63	280
	6	62	135		6	61	273
	7	61	273		7	62	135

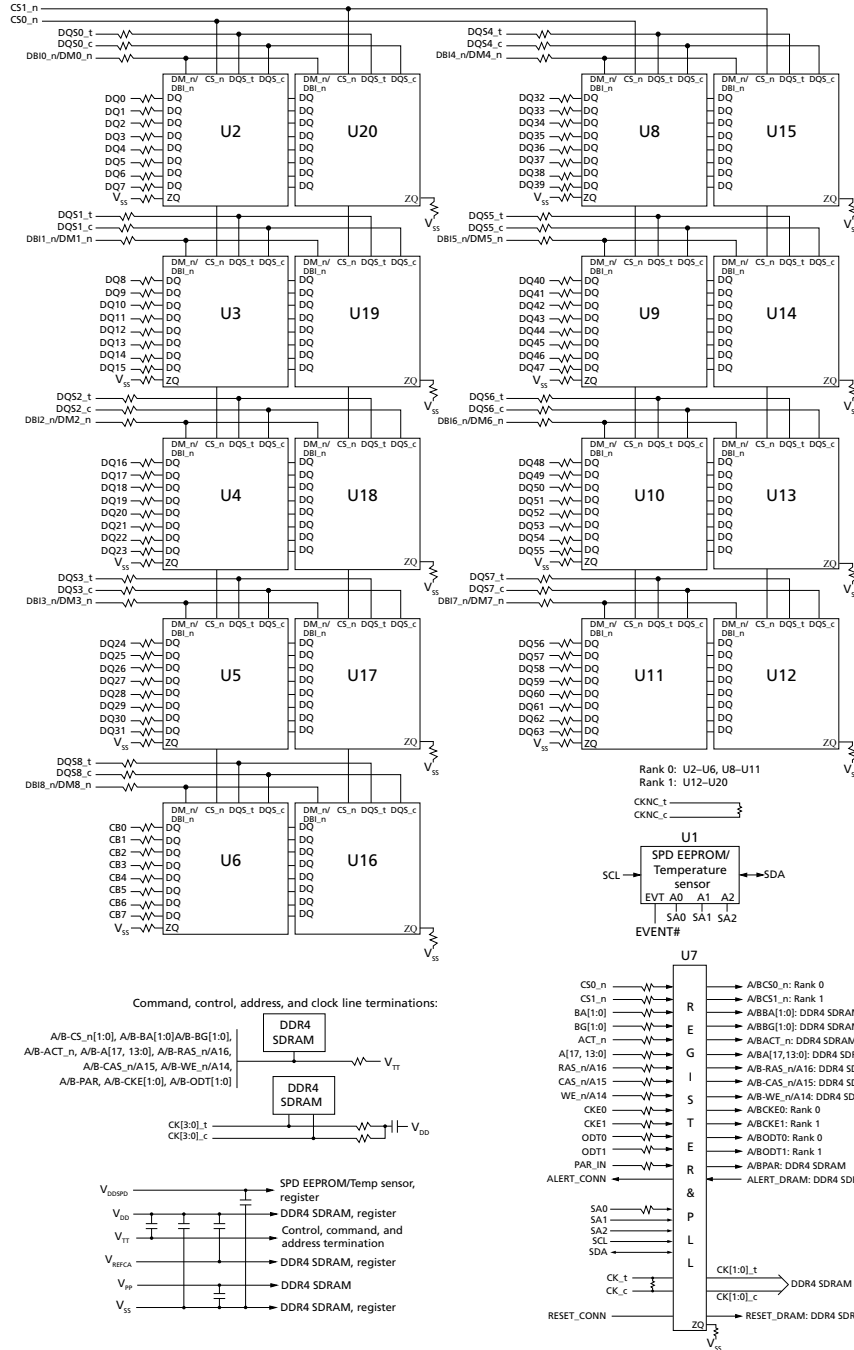

Table 5: Component-to-Module DQ Map (Continued)

Component Reference Number	Component DQ	Module DQ	Module Pin Number	Component Reference Number	Component DQ	Module DQ	Module Pin Number
U13	0	48	119	U14	0	40	108
	1	51	271		1	43	260
	2	49	264		2	41	253
	3	50	126		3	42	115
	4	52	117		4	44	106
	5	55	269		5	47	258
	6	53	262		6	45	251
	7	54	124		7	46	113
U15	0	32	97	U16	0	CB0	49
	1	35	249		1	CB3	201
	2	33	242		2	CB1	194
	3	34	104		3	CB2	56
	4	36	95		4	CB4	47
	5	39	247		5	CB7	199
	6	37	240		6	CB5	192
	7	38	102		7	CB6	54
U17	0	24	38	U18	0	16	27
	1	27	190		1	19	179
	2	25	183		2	17	172
	3	26	45		3	18	34
	4	28	36		4	20	25
	5	31	188		5	23	177
	6	29	181		6	21	170
	7	30	43		7	22	32
U19	0	8	16	U20	0	0	5
	1	11	168		1	3	157
	2	9	161		2	1	150
	3	10	23		3	2	12
	4	12	14		4	4	3
	5	15	166		5	7	155
	6	13	159		6	5	148
	7	14	21		7	6	10

## Functional Block Diagram

Figure 3: Functional Block Diagram



Note: 1. The ZQ ball on each DDR4 component is connected to an external 240Ω ±1% resistor that is tied to ground. It is used for the calibration of the component's ODT and output driver.

## General Description

High-speed DDR4 SDRAM modules use DDR4 SDRAM devices with two or four internal memory bank groups. DDR4 SDRAM modules utilizing 4- and 8-bit-wide DDR4 SDRAM devices have four internal bank groups consisting of four memory banks each, providing a total of 16 banks. 16-bit-wide DDR4 SDRAM devices have two internal bank groups consisting of four memory banks each, providing a total of eight banks. DDR4 SDRAM modules benefit from DDR4 SDRAM's use of an  $8n$ -prefetch architecture with an interface designed to transfer two data words per clock cycle at the I/O pins. A single READ or WRITE operation for the DDR4 SDRAM effectively consists of a single  $8n$ -bit-wide, four-clock data transfer at the internal DRAM core and eight corresponding  $n$ -bit-wide, one-half-clock-cycle data transfers at the I/O pins.

DDR4 modules use two sets of differential signals: DQS\_t and DQS\_c to capture data and CK\_t and CK\_c to capture commands, addresses, and control signals. Differential clocks and data strobes ensure exceptional noise immunity for these signals and provide precise crossing points to capture input signals.

## Fly-By Topology

DDR4 modules use faster clock speeds than earlier DDR technologies, making signal quality more important than ever. For improved signal quality, the clock, control, command, and address buses have been routed in a fly-by topology, where each clock, control, command, and address pin on each DRAM is connected to a single trace and terminated (rather than a tree structure, where the termination is off the module near the connector). Inherent to fly-by topology, the timing skew between the clock and DQS signals can be easily accounted for by using the write-leveling feature of DDR4.

## Module Manufacturing Location

Micron Technology manufactures modules at sites world-wide. Customers may receive modules from any of the following manufacturing locations:

**Table 6: DRAM Module Manufacturing Locations**

Manufacturing Site Location	Country of Origin Specified on Label
Boise, USA	USA
Aguadilla, Puerto Rico	Puerto Rico
Xian, China	China
Singapore	Singapore

## Address Mapping to DRAM

### Address Mirroring

To achieve optimum routing of the address bus on DDR4 multi rank modules, the address bus will be wired as shown in the table below, or mirrored. For quad rank modules, ranks 1 and 3 are mirrored and ranks 0 and 2 are non-mirrored. Highlighted address pins have no secondary functions allowing for normal operation when cross-wired. Data is still read from the same address it was written. However, Load Mode operations require a specific address. This requires the controller to accommodate for a rank that is "mirrored." Systems may reference DDR4 SPD to determine if the module has mirroring implemented or not. See the JEDEC DDR4 SPD specification for more details.

**Table 7: Address Mirroring**

Edge Connector Pin	DRAM Pin, Non-mirrored	DRAM Pin, Mirrored
A0	A0	A0
A1	A1	A1
A2	A2	A2
A3	A3	A4
A4	A4	A3
A5	A5	A6
A6	A6	A5
A7	A7	A8
A8	A8	A7
A9	A9	A9
A10	A10	A10
A11	A11	A13
A13	A13	A11
A12	A12	A12
A14	A14	A14
A15	A15	A15
A16	A16	A16
A17	A17	A17
BA0	BA0	BA1
BA1	BA1	BA0
BG0	BG0	BG1
BG1	BG1	BG0

### Registering Clock Driver Operation

Registered DDR4 SDRAM modules use a registering clock driver device consisting of a register and a phase-lock loop (PLL). The device complies with the JEDEC DDR4 RCD01 Specification.

To reduce the electrical load on the host memory controller's command, address, and control bus, Micron's RDIMMs utilize a DDR4 registering clock driver (RCD). The RCD presents a single load to the controller while redriving signals to the DDR4 SDRAM devices, which helps enable higher densities and increase signal integrity. The RCD also provides a low-jitter, low-skew PLL that redistributes a differential clock pair to multiple differential pairs of clock outputs.

### Control Words

The RCD device(s) used on DDR4 RDIMMs and LRDIMMs contain configuration registers known as control words, which the host uses to configure the RCD based on criteria determined by the module design. Control words can be set by the host controller through either the DRAM address and control bus or the I<sup>2</sup>C bus interface. The RCD I<sup>2</sup>C bus interface resides on the same I<sup>2</sup>C bus interface as the module temperature sensor and EEPROM.

### Parity Operations

The RCD includes a parity-checking function that can be enabled or disabled in control word RC0E. The RCD receives a parity bit at the DPAR input from the memory controller and compares it with the data received on the qualified command and address inputs; it indicates on its open-drain ALERT\_n pin whether a parity error has occurred. If parity checking is enabled, the RCD forwards commands to the SDRAM when no parity error has occurred. If the parity error function is disabled, the RCD forwards sampled commands to the SDRAM regardless of whether a parity error has occurred. Parity is also checked during control word WRITE operations unless parity checking is disabled.

### Rank Addressing

The chip select pins (CS\_n) on Micron's modules are used to select a specific rank of DRAM. The RDIMM is capable of selecting ranks in one of three different operating modes, dependant on setting DA[1:0] bits in the DIMM configuration control word located within the RCD. Direct DualCS mode is utilized for single- or dual-rank modules. For quad-rank modules, either direct or encoded QuadCS mode is used.

## Temperature Sensor With SPD EEPROM Operation

### Thermal Sensor Operations

The integrated thermal sensor continuously monitors the temperature of the module PCB directly below the device and updates the temperature data register. Temperature data may be read from the bus host at any time, which provides the host real-time feedback of the module's temperature. Multiple programmable and read-only temperature registers can be used to create a custom temperature-sensing solution based on system requirements and JEDEC JC-42.2.

### EVENT<sub>n</sub> Pin

The temperature sensor also adds the EVENT<sub>n</sub> pin (open-drain), which requires a pull-up to V<sub>DDSPD</sub>. EVENT<sub>n</sub> is a temperature sensor output used to flag critical events that can be set up in the sensor's configuration registers. EVENT<sub>n</sub> is not used by the serial presence-detect (SPD) EEPROM.

EVENT<sub>n</sub> has three defined modes of operation: interrupt, comparator, and TCRT. In interrupt mode, the EVENT<sub>n</sub> pin remains asserted until it is released by writing a 1 to the clear event bit in the status register. In comparator mode, the EVENT<sub>n</sub> pin clears itself when the error condition is removed. Comparator mode is always used when the temperature is compared against the TCRT limit. In TCRT only mode, the EVENT<sub>n</sub> pin is only asserted if the measured temperature exceeds the TCRT limit; it then remains asserted until the temperature drops below the TCRT limit minus the TCRT hysteresis.

### SPD EEPROM Operation

DDR4 SDRAM modules incorporate SPD. The SPD data is stored in a 512-byte, JEDEC JC-42.4-compliant EEPROM that is segregated into four 128-byte, write-protectable blocks. The SPD content is aligned with these blocks as shown in the table below.

Block	Range		Description
0	0–127	000h–07Fh	Configuration and DRAM parameters
1	128–255	080h–0FFh	Module parameters
2	256–319	100h–13Fh	Reserved (all bytes coded as 00h)
	320–383	140h–17Fh	Manufacturing information
3	384–511	180h–1FFh	End-user programmable

The first 384 bytes are programmed by Micron to comply with JEDEC standard JC-45, "Appendix X: Serial Presence Detect (SPD) for DDR4 SDRAM Modules." The remaining 128 bytes of storage are available for use by the customer.

The EEPROM resides on a two-wire I<sup>2</sup>C serial interface and is not integrated with the memory bus in any manner. It operates as a slave device in the I<sup>2</sup>C bus protocol, with all operations synchronized by the serial clock. Transfer rates of up to 1 MHz are achievable at 2.5V (NOM).

Micron implements reversible software write protection on DDR4 SDRAM-based modules. This prevents the lower 384 bytes (bytes 0 to 383) from being inadvertently programmed or corrupted. The upper 128 bytes remain available for customer use and are unprotected.

## Electrical Specifications

Stresses greater than those listed may cause permanent damage to the module. This is a stress rating only, and functional operation of the module at these or any other conditions outside those indicated in each device's data sheet is not implied. Exposure to absolute maximum rating conditions for extended periods may adversely affect reliability.

**Table 8: Absolute Maximum Ratings**

Symbol	Parameter	Min	Max	Units	Notes
V <sub>DD</sub>	V <sub>DD</sub> supply voltage relative to V <sub>SS</sub>	-0.4	1.5	V	1
V <sub>DDQ</sub>	V <sub>DDQ</sub> supply voltage relative to V <sub>SS</sub>	-0.4	1.5	V	1
V <sub>PP</sub>	Voltage on V <sub>PP</sub> pin relative to V <sub>SS</sub>	-0.4	3.0	V	2
V <sub>IN</sub> , V <sub>OUT</sub>	Voltage on any pin relative to V <sub>SS</sub>	-0.4	1.5	V	

**Table 9: Operating Conditions**

Symbol	Parameter	Min	Nom	Max	Units	Notes
V <sub>DD</sub>	V <sub>DD</sub> supply voltage	1.14	1.20	1.26	V	1
V <sub>PP</sub>	DRAM activating power supply	2.375	2.5	2.75	V	2
V <sub>REFCA(DC)</sub>	Input reference voltage – command/address bus	0.49 × V <sub>DD</sub>	0.5 × V <sub>DD</sub>	0.51 × V <sub>DD</sub>	V	3
I <sub>VTT</sub>	Termination reference current from V <sub>TT</sub>	-750	-	750	mA	
V <sub>TT</sub>	Termination reference voltage (DC) – command/address bus	0.49 × V <sub>DD</sub> - 20mV	0.5 × V <sub>DD</sub>	0.51 × V <sub>DD</sub> + 20mV	V	4
I <sub>I</sub>	Input leakage current; any input excluding ZQ; 0V < V <sub>IN</sub> < 1.1V	-	-	-	μA	5
I <sub>I</sub>	Input leakage current; ZQ	-3	-	3	μA	6, 7
I <sub>I/O</sub>	DQ leakage; 0V < V <sub>IN</sub> < V <sub>DD</sub>	-4	-	4	μA	7
I <sub>OZpd</sub>	Output leakage current; V <sub>OUT</sub> = V <sub>DD</sub> ; DQ is disabled	-	-	5	μA	
I <sub>OZpu</sub>	Output leakage current; V <sub>OUT</sub> = V <sub>SS</sub> ; DQ and ODT are disabled; ODT is disabled with ODT input HIGH	-	-	50	μA	
I <sub>VREFCA</sub>	V <sub>REFCA</sub> leakage; V <sub>REFCA</sub> = V <sub>DD</sub> /2 (after DRAM is initialized)	-2	-	2	μA	7

- Notes:
1. V<sub>DDQ</sub> balls on DRAM are tied to V<sub>DD</sub>.
  2. V<sub>PP</sub> must be greater than or equal to V<sub>DD</sub> at all times.
  3. V<sub>REFCA</sub> must not be greater than 0.6 × V<sub>DD</sub>. When V<sub>DD</sub> is less than 500mV, V<sub>REF</sub> may be less than or equal to 300mV.
  4. V<sub>TT</sub> termination voltages in excess of specification limit adversely affect command and address signals' voltage margins and reduce timing margins.
  5. Command and address inputs are terminated to V<sub>DD</sub>/2 in the registering clock driver. Input current is dependent on termination resistance set in the registering clock driver.
  6. Tied to ground. Not connected to edge connector.
  7. Multiply by number of DRAM die on module.

**Table 10: Thermal Characteristics**

Symbol	Parameter/Condition	Value	Units	Notes
$T_C$	Commercial operating case temperature	0 to 85	°C	1, 2, 3
$T_C$		>85 to 95	°C	1, 2, 3, 4
$T_{OPER}$	Normal operating temperature range	0 to 85	°C	5, 7
$T_{OPER}$	Extended temperature operating range (optional)	>85 to 95	°C	5, 7
$T_{STG}$	Non-operating storage temperature	-55 to 100	°C	6
$RH_{STG}$	Non-operating Storage Relative Humidity (non-condensing)	5 to 95	%	
NA	Change Rate of Storage Temperature	20	°C/hour	

- Notes:
1. Maximum operating case temperature;  $T_C$  is measured in the center of the package.
  2. A thermal solution must be designed to ensure the DRAM device does not exceed the maximum  $T_C$  during operation.
  3. Device functionality is not guaranteed if the DRAM device exceeds the maximum  $T_C$  during operation.
  4. If  $T_C$  exceeds 85°C, the DRAM must be refreshed externally at 2X refresh, which is a 3.9µs interval refresh rate.
  5. The refresh rate must double when 85°C <  $T_{OPER}$  ≤ 95°C.
  6. Storage temperature is defined as the temperature of the top/center of the DRAM and does not reflect the storage temperatures of shipping trays.
  7. For additional information, refer to technical note TN-00-08: "Thermal Applications" available at [micron.com](http://micron.com).

## DRAM Operating Conditions

Recommended AC operating conditions are given in the DDR4 component data sheets. Component specifications are available at [micron.com](http://micron.com). Module speed grades correlate with component speed grades, as shown below.

**Table 11: Module and Component Speed Grades**

DDR4 components may exceed the listed module speed grades; module may not be available in all listed speed grades

Module Speed Grade	Component Speed Grade
-2G6	-075
-2G4	-083E
-2G3	-083
-2G1	-093E
-1G9	-107E

## Design Considerations

### Simulations

Micron memory modules are designed to optimize signal integrity through carefully designed terminations, controlled board impedances, routing topologies, trace length matching, and decoupling. However, good signal integrity starts at the system level. Micron encourages designers to simulate the signal characteristics of the system's memory bus to ensure adequate signal integrity of the entire memory system.

### Power

Operating voltages are specified at the edge connector of the module, not at the DRAM. Designers must account for any system voltage drops at anticipated power levels to ensure the required supply voltage is maintained.

## I<sub>DD</sub> Specifications

**Table 12: DDR4 I<sub>DD</sub> Specifications and Conditions – 8GB (Die Revision A)**

Values are for the MT40A512M8 DDR4 SDRAM only and are computed from values specified in the 4Gb (512 Meg x 8) component data sheet

Parameter	Symbol	2400	2133	Units
One bank ACTIVATE-PRECHARGE current	I <sub>DD0</sub> <sup>1</sup>	864	810	mA
One bank ACTIVATE-PRECHARGE, wordline boost, I <sub>pp</sub> current	I <sub>PP0</sub> <sup>1</sup>	63	63	mA
One bank ACTIVATE-READ-PRECHARGE current	I <sub>DD1</sub> <sup>1</sup>	900	855	mA
Precharge standby current	I <sub>DD2N</sub> <sup>2</sup>	900	828	mA
Precharge standby ODT current	I <sub>DD2NT</sub> <sup>1</sup>	810	756	mA
Precharge power-down current	I <sub>DD2P</sub> <sup>2</sup>	576	540	mA
Precharge quiet standby current	I <sub>DD2Q</sub> <sup>2</sup>	738	702	mA
Active standby current	I <sub>DD3N</sub> <sup>2</sup>	1206	1134	mA
Active standby I <sub>pp</sub> current	I <sub>PP3N</sub> <sup>2</sup>	54	54	mA
Active power-down current	I <sub>DD3P</sub> <sup>2</sup>	792	792	mA
Burst read current	I <sub>DD4R</sub> <sup>1</sup>	1728	1620	mA
Burst read I <sub>DDQ</sub> current	I <sub>DDQ4R</sub> <sup>1</sup>	648	594	mA
Burst write current	I <sub>DD4W</sub> <sup>1</sup>	1908	1710	mA
Burst refresh current (1x REF)	I <sub>DD5B</sub> <sup>1</sup>	2016	1980	mA
Burst refresh I <sub>pp</sub> current (1x REF)	I <sub>PP5B</sub> <sup>1</sup>	225	225	mA
Self refresh current: Normal temperature range (0°C to 85°C)	I <sub>DD6N</sub> <sup>2</sup>	360	360	mA
Self refresh current: Extended temperature range (0°C to 95°C)	I <sub>DD6E</sub> <sup>2</sup>	486	486	mA
Self refresh current: Reduced temperature range (0°C to 45°C)	I <sub>DD6R</sub> <sup>2</sup>	180	180	mA
Auto self refresh current (25°C)	I <sub>DD6A</sub> <sup>2</sup>	162	162	mA
Auto self refresh current (45°C)	I <sub>DD6A</sub> <sup>2</sup>	180	180	mA
Auto self refresh current (75°C)	I <sub>DD6A</sub> <sup>2</sup>	288	288	mA
Bank interleave read current	I <sub>DD7</sub> <sup>1</sup>	2178	1935	mA
Bank interleave read I <sub>pp</sub> current	I <sub>PP7</sub> <sup>1</sup>	153	135	mA
Maximum power-down current	I <sub>DD8</sub> <sup>2</sup>	324	324	mA

- Notes: 1. One module rank in the active I<sub>DD/PP</sub>, the other rank in I<sub>DD2P/PP3N</sub>.  
2. All ranks in this I<sub>DD/PP</sub> condition.

**Table 13: DDR4 I<sub>DD</sub> Specifications and Conditions – 8GB (Die Revision B)**

Values are for the MT40A512M8 DDR4 SDRAM only and are computed from values specified in the 4Gb (512 Meg x 8) component data sheet

Parameter	Symbol	2400	2133	Units
One bank ACTIVATE-PRECHARGE current	I <sub>DD0</sub> <sup>1</sup>	801	738	mA
One bank ACTIVATE-PRECHARGE, wordline boost, I <sub>PP</sub> current	I <sub>PP0</sub> <sup>1</sup>	54	54	mA
One bank ACTIVATE-READ-PRECHARGE current	I <sub>DD1</sub> <sup>1</sup>	846	783	mA
Precharge standby current	I <sub>DD2N</sub> <sup>2</sup>	810	756	mA
Precharge standby ODT current	I <sub>DD2NT</sub> <sup>1</sup>	711	693	mA
Precharge power-down current	I <sub>DD2P</sub> <sup>2</sup>	522	486	mA
Precharge quiet standby current	I <sub>DD2Q</sub> <sup>2</sup>	666	630	mA
Active standby current	I <sub>DD3N</sub> <sup>2</sup>	1080	990	mA
Active standby I <sub>PP</sub> current	I <sub>PP3N</sub> <sup>2</sup>	54	54	mA
Active power-down current	I <sub>DD3P</sub> <sup>2</sup>	720	720	mA
Burst read current	I <sub>DD4R</sub> <sup>1</sup>	1566	1458	mA
Burst write current	I <sub>DD4W</sub> <sup>1</sup>	1836	1638	mA
Burst refresh current (1x REF)	I <sub>DD5B</sub> <sup>1</sup>	1836	1773	mA
Burst refresh I <sub>PP</sub> current (1x REF)	I <sub>PP5B</sub> <sup>1</sup>	225	225	mA
Self refresh current: Normal temperature range (0°C to 85°C)	I <sub>DD6N</sub> <sup>2</sup>	324	324	mA
Self refresh current: Extended temperature range (0°C to 95°C)	I <sub>DD6E</sub> <sup>2</sup>	432	432	mA
Self refresh current: Reduced temperature range (0°C to 45°C)	I <sub>DD6R</sub> <sup>2</sup>	216	216	mA
Auto self refresh current (25°C)	I <sub>DD6A</sub> <sup>2</sup>	162	162	mA
Auto self refresh current (45°C)	I <sub>DD6A</sub> <sup>2</sup>	216	216	mA
Auto self refresh current (75°C)	I <sub>DD6A</sub> <sup>2</sup>	324	324	mA
Bank interleave read current	I <sub>DD7</sub> <sup>1</sup>	1971	1728	mA
Bank interleave read I <sub>PP</sub> current	I <sub>PP7</sub> <sup>1</sup>	153	135	mA
Maximum power-down current	I <sub>DD8</sub> <sup>2</sup>	288	288	mA

- Notes: 1. One module rank in the active I<sub>DD</sub>/I<sub>PP</sub>, the other rank in I<sub>DD2P</sub>/I<sub>PP3N</sub>.  
2. All ranks in this I<sub>DD</sub>/I<sub>PP</sub> condition.

## Registering Clock Driver Specifications

**Table 14: Registering Clock Driver Electrical Characteristics**

DDR4 RCD01 devices or equivalent

Parameter	Symbol	Pins	Min	Nom	Max	Units
DC supply voltage	$V_{DD}$	–	1.14	1.2	1.26	V
DC reference voltage	$V_{REF}$	$V_{REFCA}$	$0.49 \times V_{DD}$	$0.5 \times V_{DD}$	$0.51 \times V_{DD}$	V
DC termination voltage	$V_{TT}$	–	$V_{REF} - 40mV$	$V_{REF}$	$V_{REF} + 40mV$	V
High-level input voltage	$V_{IH, CMOS}$	DRST_n	$0.65 \times V_{DD}$	–	$V_{DD}$	V
Low-level input voltage	$V_{IL, CMOS}$		0	–	$0.35 \times V_{DD}$	V
DRST_n pulse width	$t_{IN-IT\_Power\_stable}$	–	1.0	–	–	$\mu s$
AC high-level output voltage	$V_{OH(AC)}$	All outputs except ALERT_n	$V_{TT} + (0.15 \times V_{DD})$	–	–	V
AC low-level output voltage	$V_{OL(AC)}$		–	–	$V_{TT} + (0.15 \times V_{DD})$	V
AC differential output high measurement level (for output slew rate)	$V_{OHdiff(AC)}$	Yn_t - Yn_c, BCK_t - BCK_c	–	$0.3 \times V_{DD}$	–	mV
AC differential output low measurement level (for output slew rate)	$V_{OLDiff(AC)}$		–	$-0.3 \times V_{DD}$	–	mV

- Note: 1. Timing and switching specifications for the register listed are critical for proper operation of DDR4 SDRAM RDIMMs. These are meant to be a subset of the parameters for the specific device used on the module. See the JEDEC RCD01 specification for complete operating electrical characteristics. Registering clock driver parametric values are specified for device default control word settings, unless otherwise stated. The RCOA control word setting does not affect parametric values.

## Temperature Sensor With SPD EEPROM

The temperature sensor continuously monitors the module's temperature and can be read back at any time over the I<sup>2</sup>C bus shared with the serial presence-detect (SPD) EEPROM. Refer to JEDEC JC-42.4 EE1004 and TSE2004 device specifications for complete details.

### SPD Data

For the latest SPD data, refer to Micron's SPD page: [micron.com/SPD](http://micron.com/SPD).

**Table 15: Temperature Sensor With SPD EEPROM Operating Conditions**

Parameter/Condition	Symbol	Min	Nom	Max	Units
Supply voltage	V <sub>DDSPD</sub>	–	2.5	–	V
Input low voltage: logic 0; all inputs	V <sub>IL</sub>	–0.5	–	V <sub>DDSPD</sub> × 0.3	V
Input high voltage: logic 1; all inputs	V <sub>IH</sub>	V <sub>DDSPD</sub> × 0.7	–	V <sub>DDSPD</sub> + 0.5	V
Output low voltage: 3mA sink current V <sub>DDSPD</sub> > 2V	V <sub>OL</sub>	–	–	0.4	V
Input leakage current: (SCL, SDA) V <sub>IN</sub> = V <sub>DDSPD</sub> or V <sub>SSSPD</sub>	I <sub>LI</sub>	–	–	±5	μA
Output leakage current: V <sub>OUT</sub> = V <sub>DDSPD</sub> or V <sub>SSSPD</sub> , SDA in High-Z	I <sub>LO</sub>	–	–	±5	μA

**Table 16: Temperature Sensor and EEPROM Serial Interface Timing**

Parameter/Condition	Symbol	Min	Max	Units
Clock frequency	f <sub>SCL</sub>	10	1000	kHz
Clock pulse width HIGH time	t <sub>HIGH</sub>	260	–	ns
Clock pulse width LOW time	t <sub>LOW</sub>	500	–	ns
Detect clock LOW timeout	t <sub>TIMEOUT</sub>	25	35	ms
SDA rise time	t <sub>R</sub>	–	120	ns
SDA fall time	t <sub>F</sub>	–	120	ns
Data-in setup time	t <sub>SU:DAT</sub>	50	–	ns
Data-in hold time	t <sub>HD:DI</sub>	0	–	ns
Data out hold time	t <sub>HD:DAT</sub>	0	350	ns
Start condition setup time	t <sub>SU:STA</sub>	260	–	ns
Start condition hold time	t <sub>HD:STA</sub>	260	–	ns
Stop condition setup time	t <sub>SU:STO</sub>	260	–	ns
Time the bus must be free before a new transition can start	t <sub>BUF</sub>	500	–	ns
Write time	t <sub>W</sub>	–	5	ms
Warm power cycle time off	t <sub>POFF</sub>	1	–	ms
Time from power-on to first command	t <sub>INIT</sub>	10	–	ms

## Module Dimensions

Figure 4: 288-Pin DDR4 RDIMM (R/C-E)

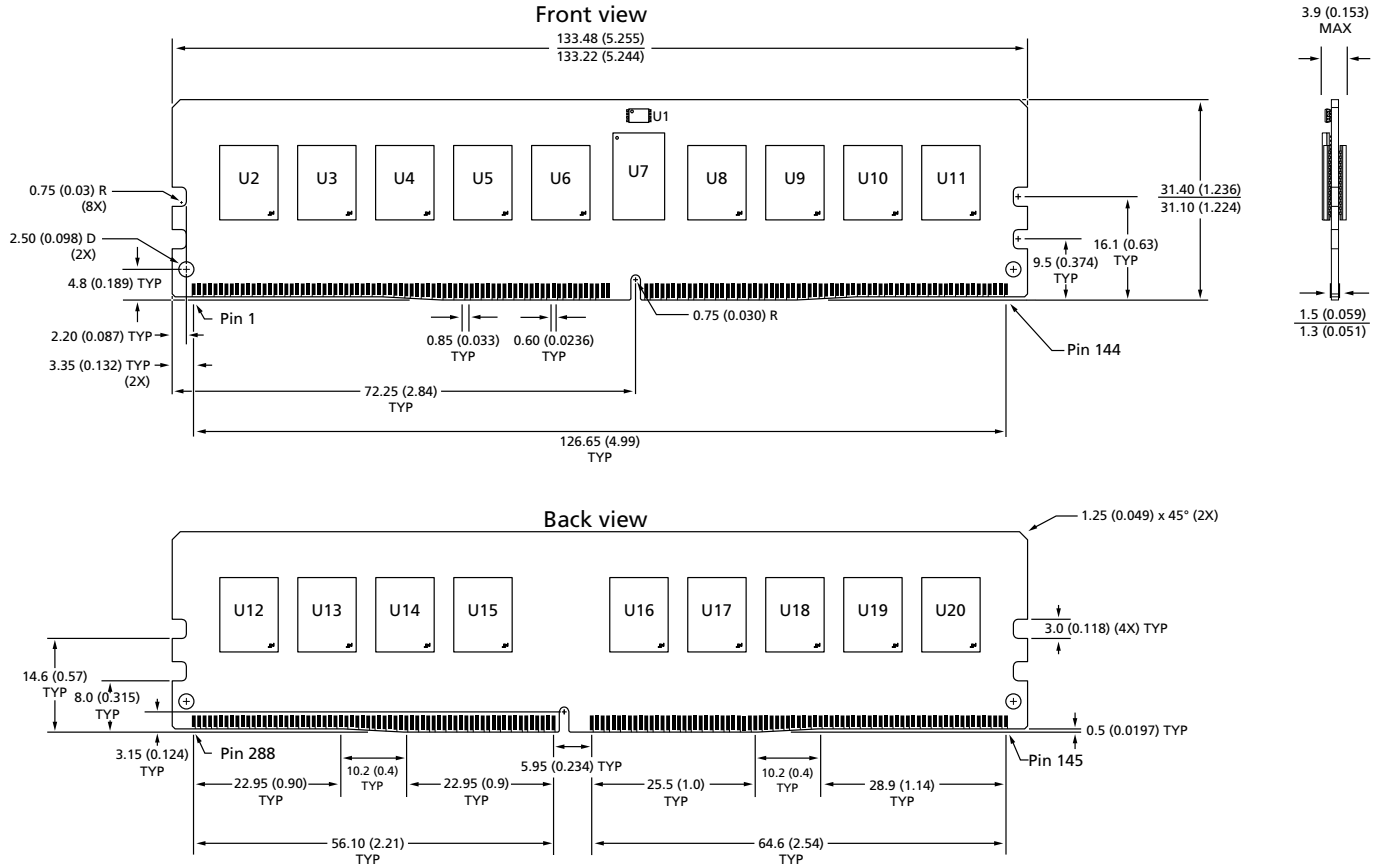

- Notes: 1. All dimensions are in millimeters (inches); MAX/MIN or typical (TYP) where noted.  
 2. The dimensional diagram is for reference only.

**Figure 5: 288-Pin DDR4 RDIMM (R/C-E1)**

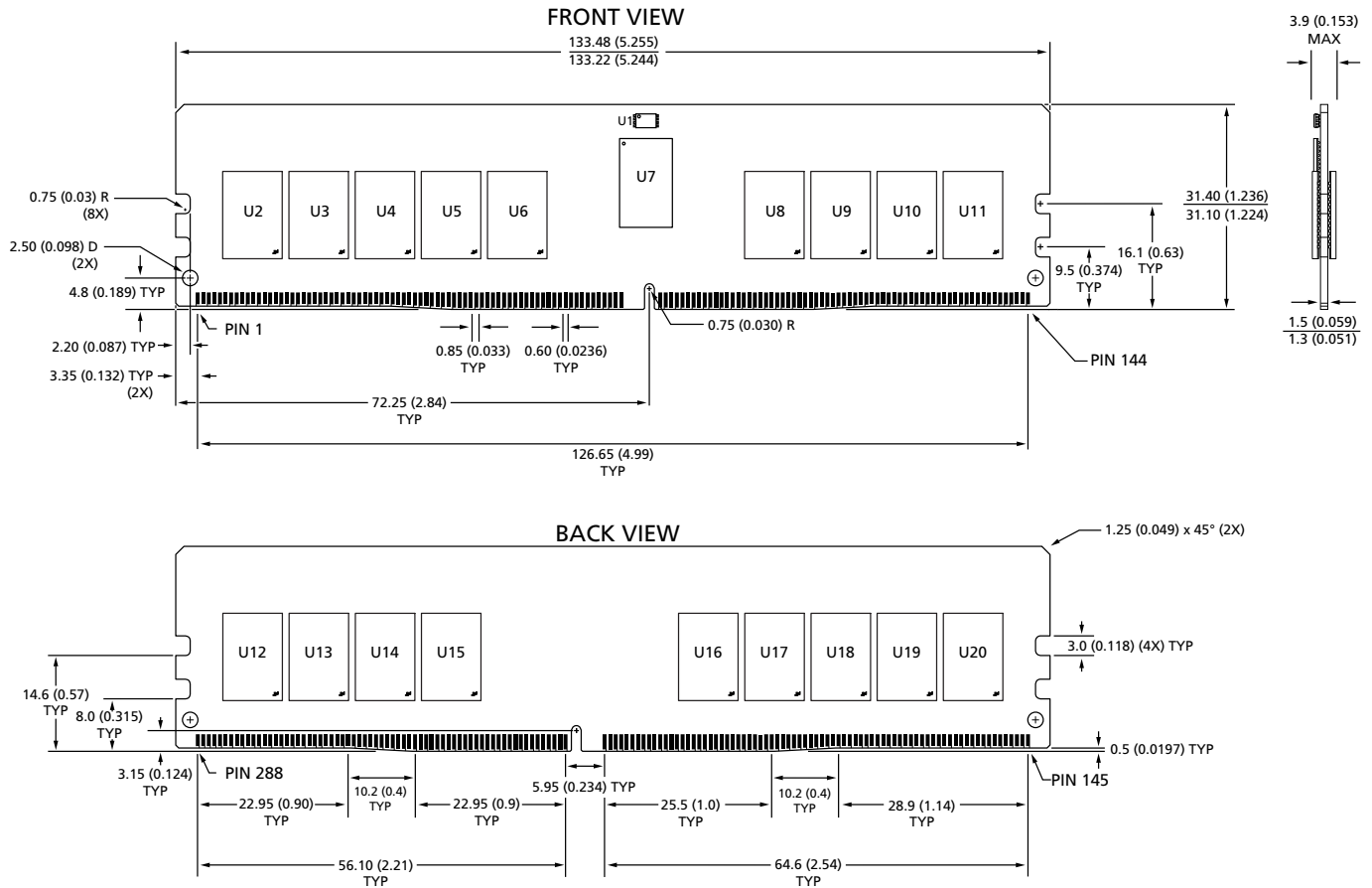



- Notes: 1. All dimensions are in millimeters (inches); MAX/MIN or typical (TYP) where noted.  
 2. The dimensional diagram is for reference only.

8000 S. Federal Way, P.O. Box 6, Boise, ID 83707-0006, Tel: 208-368-4000  
[www.micron.com/products/support](http://www.micron.com/products/support) Sales inquiries: 800-932-4992  
 Micron and the Micron logo are trademarks of Micron Technology, Inc.  
 All other trademarks are the property of their respective owners.

This data sheet contains minimum and maximum limits specified over the power supply and temperature range set forth herein. Although considered final, these specifications are subject to change, as further product development and data characterization sometimes occur.

## Looking for pricing, stock, or lifecycle information?

Click below to explore more details on WIN SOURCE:

-  [View MTA18ASF1G72PDZ-2G1A1 on WIN SOURCE](#)
-  [Micron Technology Inc. Information](#)

## Optimize Your Supply Chain with WIN SOURCE Solutions

-  Global Sourcing Solution
-  Obsolete Management
-  Cost Control Management
-  Shortage Management
-  Alternative Solution
-  Excess Inventory Management