

Video Accessory ICs

NTSC / PAL

Analog Video Encoders



BH7236AF, BH7240AKV

No.10069EAT06

●Description

BH7236AF and BH7240AKV are NTSC/PAL analog video encoders which convert R, G, and B component signals to 6 types video signal format for NTSC and PAL: Composite video output, luminance output, chrominance output and R, G, and B output. The encoders eliminate the need for complicated register settings and require only few external parts.

●Features

- 1) BH7236AF –RGB analog input. BH7240AKV: RGB 8bit digital input
- 2) 6 outputs support (V, Y, C, R, G, B, however BH7236AF also supports sync output)
- 3) NTSC/PAL support
- 4) 5.0V single power supply
- 5) Logic input 3.0V to 5.0V
- 6) Subcarrier input (corresponded to sine-wave and pulse-wave)
- 7) Built-in 75Ω driver
- 8) High-speed DAC (only BH7240AKV)
- 9) Few external parts
- 10) LC filter for reducing cross-color (with external parts)
- 11) Unnecessary Initialization
- 12) Package (SOP24 :BH7236AF :VQFP48C :BH7240AKV)

●Applications

Video Games, Television Display Terminals, etc.

●Line up matrix

Parameter	BH7236AF	BH7240AKV
Input format	R,G,B analog	R,G,B digital (Parallel 8bit × 3)
Output format	7output VOUT : composite video output YOUT : luminance signal output COUT : color signal output ROUT : Red signal output GOUT : Green signal output BOUT : Blue signal output SYNCOUT: composite sync output	6 output VOUT :composite video output YOUT :luminance signal output COUT :color signal output ROUT :Red signal output GOUT :Green signal output BOUT :Blue signal output
Input DAC(only BH7240AKV)	-	Built-in(8bit × 3)
Package	SOP24	VQFP48C

● Absolute maximum ratings

Parameter		Symbol	Ratings	Unit
Supply voltage		VCC	7	V
Power dissipation	BH7236AF	Pd	550 ※1	mW
	BH7240AKV		900 ※2	
Storage temperature range		Tstg	-55 ~ +125	°C

※1 Reduce by 5.5mW/°C over 25°C (A measured value at mounting on 50 × 50 × 1.6mm glass epoxy substrate.)

※2 Reduce by 9.0mW/°C over 25°C (A measured value at mounting on 50 × 50 × 1.6mm glass epoxy substrate.)

● Recommended operation ratings

Parameter		Symbol	Ratings	Unit
Supply voltage		VCC	4.5 ~ 5.5	V
Operation temperature range		Topr	-20 ~ +70	°C
Input High level (SYNCIN, NT/PAL)		VIH	2.2 ~ 5.0 ※1	V
Input Low level (SYNCIN, NT/PAL)		VIL	0.0 ~ 0.8 ※1	V
Input level (SCIN)		Vsci	0.4 ~ 5.0	Vpp
[BH7236AF]				
Input level (R, G, B)		Vrgbi	0 ~ 1.0	Vpp
[BH7240AKV]				
Input High level (VCLK, RDATA, GDATA, BDATA)		VIH2	2.2 ~ 5.0 ※1	V
Input Low level (VCLK, RDATA, GDATA, BDATA)		VIL2	0 ~ 0.8 ※1	V

※1 BH7236AF: VCC1=VCC2=5.0V BH7240AKV: DVDD=AVCC1=AVCC2=5.0V

●Electrical characteristics

©BH7236AF(Ta=25°C, VCC1=VCC2=5.0V unless otherwise noted.)

Parameter	Symbol	Limits			Unit	Condition
		Min.	Typ.	Max.		
Consumption current	Icc	-	42	55	mA	RIN=GIN=BIN=0.0Vpp input
Luminance level (Vout, Yout)						
White level	Vlwhite	0.63	0.70	0.77	Vpp	RIN=GIN=BIN=1.0Vpp input
Red level	Vlred	0.19	0.21	0.23	Vpp	RIN= 1.0Vpp input
Green level	Vlgreen	0.37	0.41	0.45	Vpp	GIN= 1.0Vpp input
Blue level	Vlblue	0.07	0.08	0.09	Vpp	BIN= 1.0Vpp input
Sync level	Vsync	0.27	0.30	0.33	Vpp	
Sync/White level ratio	Rs/w	0.38	0.43	0.48		Rs/w = Vsync/Vlwhite
Chroma level (Vout, Cout)						
Red/Burst level ratio	Vcr/Vbur	2.84	3.16	3.48	-	RIN= 1.0Vpp input ※1
Green/Burst level ratio	Vcg/Vbur	2.65	2.95	3.25	-	GIN= 1.0Vpp input ※1
Blue/Burst level ratio	Vcb/Vbur	2.01	2.24	2.47	-	BIN= 1.0Vpp input ※1
Burst level	Vbur	0.23	0.29	0.35	Vpp	※2
Red phase	θ red	94	104	114	deg	RIN= 1.0Vpp input ※1
Green phase	θ green	231	241	251	deg	GIN= 1.0Vpp input ※1
Blue phase	θ blue	337	347	357	deg	BIN= 1.0Vpp input ※1
PAL burst phase	θ bur+	125	135	145	deg	Color subcarrier ※1 =4.433619MHz (NT/PAL = L)
	θ bur-	215	225	235	deg	
PAL burst level ratio	Rbur	0.9	1.0	1.1	-	Level ratio per line
Carrier leak	Vcl	-	-	35	mVpp	※2
RGB level (Rout, Gout, Bout)						
Red level	Vro	0.63	0.70	0.77	Vpp	RIN= 1.0Vpp input
Green level	Vgo	0.63	0.70	0.77	Vpp	GIN= 1.0Vpp input
Blue level	Vbo	0.63	0.70	0.77	Vpp	BIN= 1.0Vpp input
SYNCOUT High level	Vhsync	3.90	-	-	V	
SYNCOUT Low level	Vlsync	-	-	0.80	V	
Output DC voltage						
YOUT	Vyo	1.30	1.70	2.10	V	
COUT	Vco	2.00	2.40	2.80	V	
VOUT	Vvo	1.15	1.55	1.95	V	
ROUT	Vro	1.40	1.80	2.20	V	
GOUT	Vgo	1.40	1.80	2.20	V	
BOUT	Vbo	1.40	1.80	2.20	V	

※1 This specification is design target.

※2 This specification is measured with 3.58MHz BPF.

©BH7240AKV(Ta=25°C, DVDD=AVCC1=AVCC2=5.0V unless otherwise noted.)

Parameter	Symbol	Limits			Unit	Condition
		Min.	Typ.	Max.		
Consumption current	Icc	-	85	105	mA	RGB DATA=00h input
Luminance level (Vout, Yout)						
White level	Vlwhite	0.59	0.70	0.81	Vpp	RGB DATA=FFh input
Red level	Vlred	0.18	0.21	0.24	Vpp	R DATA=FFh input
Green level	Vlgreen	0.35	0.41	0.47	Vpp	G DATA=FFh input
Blue level	Vlblue	0.07	0.08	0.09	Vpp	B DATA=FFh input
Sync level	Vsync	0.27	0.30	0.33	Vpp	
Sync/White level ratio	Rs/w	0.37	0.43	0.49		
Chroma level (Vout, Cout)						
Red/Burst level ratio	Vcr/Vbur	2.69	3.16	3.63	-	R DATA=FFh input ※1
Green/Burst level ratio	Vcg/Vbur	2.51	2.95	3.39	-	G DATA=FFh input ※1
Blue/Burst level ratio	Vcb/Vbur	1.91	2.24	2.57	-	B DATA=FFh input ※1
Burst level	Vbur	0.25	0.29	0.33	Vpp	※2
Red phase	θ red	94	104	114	deg	R DATA=FFh input ※1
Green phase	θ green	231	241	251	deg	G DATA=FFh input ※1
Blue phase	θ blue	337	347	357	deg	B DATA=FFh input ※1
RGB level (Rout, Gout, Bout)						
Red level	Vrout	0.56	0.70	0.81	Vpp	R DATA=FFh input
Green level	Vgout	0.59	0.70	0.81	Vpp	G DATA=FFh input
Blue level	Vbout	0.59	0.70	0.81	Vpp	B DATA=FFh input
Others						
RGB DATA conversion frequency	Fda	-	-	20	MHz	
RGB DATA Set-up time	Tset	20	-	-	nsec	
RGB DATA Hold-time	Thold	20	-	-	nsec	
SYNCIN, NT/PAL Input current at High	IH	-	-	300	μ A	Terminal is applied to 5V.
SYNCIN, NT/PAL Input current at Low	IL	-200	-	-	μ A	Terminal is applied to 0V.

※1 This specification is design target.

※2 This specification is measured with 3.58MHz BPF.

Notes:

- 1) Please use these semiconductor devices within the guaranteed temperature range. ROHM guarantees -20 to 70°C
- 2) The accuracy of subcarrier signal is important and is specified as 2.8ppm, per the television standard. It is recommended to use a crystal oscillator as the subcarrier input. Since the margin of accuracy is not guaranteed for all televisions (can be up to 100ppm).
- 3) The unused RGB CMOS data input of the BU7240AKV must be terminated to "high" or "low" level.

● Block diagram, Application circuit, Pin arrangement
(BH7236AF)

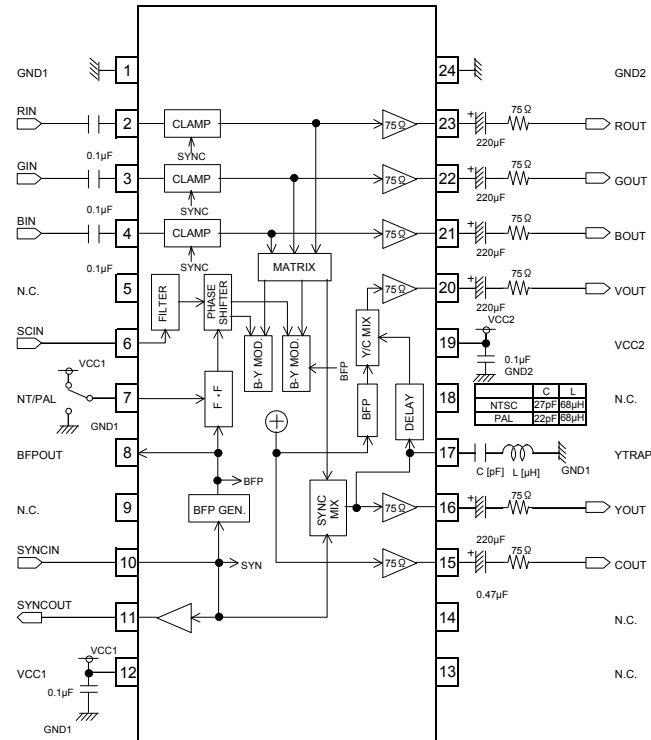

Fig. 1 BH7236AF Block Diagram

Terminal number	Terminal name	Description of terminals
1	GND1	Ground terminal. (For all circuits except 75 Ω driver)
2	RIN	Analog Red signal input terminal. This signal should be driven at sufficiently low impedance.
3	GIN	Analog Green signal input terminal. This signal should be driven at sufficiently low impedance.
4	BIN	Analog Blue signal input terminal. This signal should be driven at sufficiently low impedance.
5	N.C.	No Connection. (Not connected internally)
6	SCIN	Color subcarrier input terminal. Input the sine-wave or pulse-wave (duty 50%) according to a required output format (3.579545MHz for NTSC, 4.433619MHz for PAL). Moreover, this input must not exceed more than power supply level and less than ground level.
7	NT/PAL	Input terminal for the selection of TV output format. Connect "high" for NTSC and "low" for PAL. The internal pull-up register 50k Ω is connected NT/PAL to VCC.
8	BFPOUT	Burst timing signal output terminal. The burst timing signal is generated inside the device by inputting a color subcarrier and a composite sync.
9	N.C.	No Connection. (not connected internally)
10	SYNCIN	Composite sync input terminal. Composite sync is output to YOUT and VOUT at the timing when SYNCIN is set to "low". Moreover, RGB input signals are dc-clamped internally at this timing. The internal pull-up register 100k Ω is connected to VCC.
11	SYNCOUT	Composite sync output terminal.
12	VCC1	Power supply terminal. (for all circuits except 75 Ω driver)
13	N.C.	No Connection. (not connected internally)
14	N.C.	No Connection. (not connected internally)
15	COUT	Chroma signal output terminal. Built-in 75 Ω driver.
16	YOUT	Luminance signal output terminal. Built-in 75 Ω driver.
17	YTRAP	Luminance trap terminal. The output impedance is about 2k Ω.
18	N.C.	No Connection. (Not connected internally)
19	VCC2	Power supply terminal. (for 75 Ω driver)
20	VOUT	Composite video output terminal. Built-in 75 Ω driver.
21	BOUT	Analog B signal output terminal. Built-in 75 Ω driver.
22	GOUT	Analog G signal output terminal. Built-in 75 Ω driver.
23	ROUT	Analog R signal output terminal. Built-in 75 Ω driver.
24	GND2	Ground terminal (for 75 Ω driver)

(BH7240AKV)

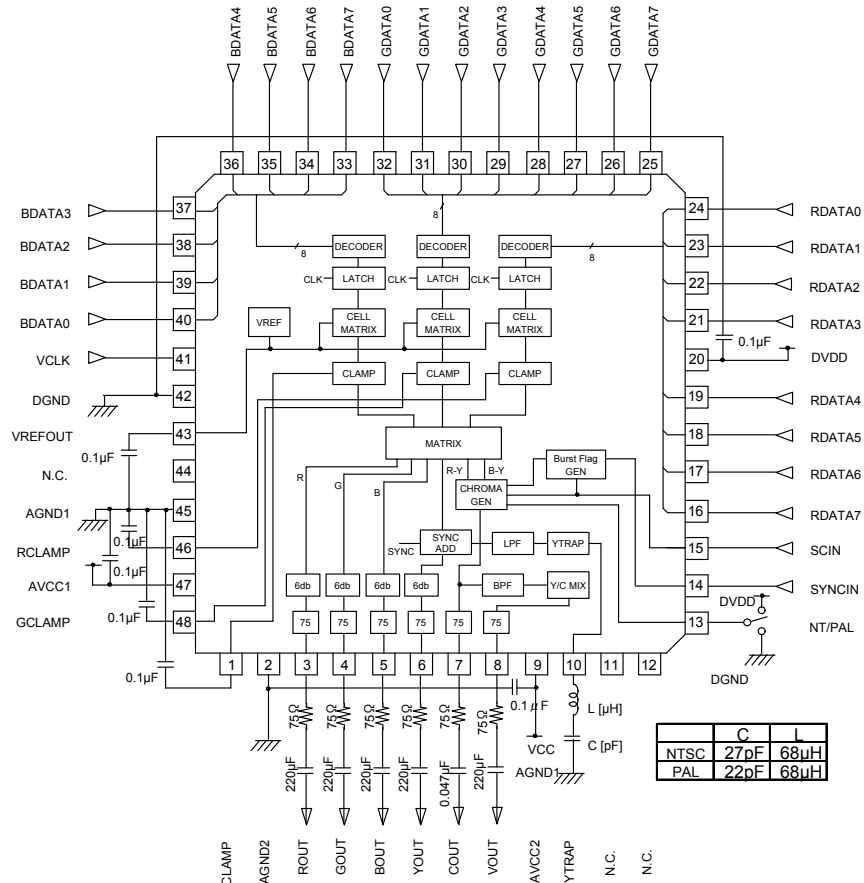

Fig. 2 BH7240AKV Block Diagram

Terminal number	Terminal name	Description of terminals
1	BCLAMP	Analog Blue signal clamp terminal.
2	AGND2	Ground terminal. (For 75Ω driver)
3	ROUT	Analog Red signal output terminal. Built-in 75Ω driver.
4	GOUT	Analog Green signal output terminal. Built-in 75Ω driver.
5	BOUT	Analog Blue signal output terminal. Built-in 75Ω driver.
6	YOUT	Luminance signal output terminal. Built-in 75Ω driver.
7	COUT	Chrominance signal output terminal. Built-in 75Ω driver.
8	VOUT	Composite video signal output terminal. Built-in 75Ω driver.
9	AVCC2	Power supply terminal. (For 75Ω driver)
10	YTRAP	Luminance trap filter terminal. By connecting it, the chrominance component contained in a luminance signal is eliminated, and cross-color gets reduced. Output impedance is about 2kΩ. It's effective for only the composite video output.
11	N.C.	No Connection. (Not connected internally)
12	N.C.	No Connection. (Not connected internally)
13	NT/PAL	Input terminal for the selection of TV output format. Connect to NT/PAL, "high" for NTSC and "low" for PAL.
14	SYNCIN	Composite sync input terminal. Composite sync is output to YOUT and VOUT at the timing when SYNCIN is set to "low". Moreover, RGB input signals are dc-clamped internally at this timing.
15	SCIN	Color subcarrier input terminal. Input the sine-wave or pulse-wave (duty 50%) according to a required output format (3.579545MHz for NTSC, 4.433619MHz for PAL). Moreover, this input must not exceed more than power supply level and less than ground level.

Terminal number	Terminal name	Description of terminals
16	RDATA7	Red data input terminal (bit 7)
17	RDATA6	Red data input terminal (bit 6)
18	RDATA5	Red data input terminal (bit 5)
19	RDATA4	Red data input terminal (bit 4)
20	DVDD	The power supply terminal for digital circuits.
21	RDATA3	Red data input terminal (bit 3)
22	RDATA2	Red data input terminal (bit 2)
23	RDATA1	Red data input terminal (bit 1)
24	RDATA0	Red data input terminal (bit 0)
25	GDATA7	Green data input terminal (bit 7)
26	GDATA6	Green data input terminal (bit 6)
27	GDATA5	Green data input terminal (bit 5)
28	GDATA4	Green data input terminal (bit 4)
29	GDATA3	Green data input terminal (bit 3)
30	GDATA2	Green data input terminal (bit 2)
31	GDATA1	Green data input terminal (bit 1)
32	GDATA0	Green data input terminal (bit 0)
33	BDATA7	Blue data input terminal (bit 7)
34	BDATA6	Blue data input terminal (bit 6)
35	BDATA5	Blue data input terminal (bit 5)
36	BDATA4	Blue data input terminal (bit 4)
37	BDATA3	Blue data input terminal (bit 3)
38	BDATA2	Blue data input terminal (bit 2)
39	BDATA1	Blue data input terminal (bit 1)
40	BDATA0	Blue data input terminal (bit 0)
41	VCLK	DAC clock input. By rising edge of this clock, RGB data are taken in inside the device.
42	DGND	Ground terminal. (For digital circuits)
43	VREFOUT	RGBDAC reference voltage output terminal. Connect VREFOUT to GND through 0.1 μ F capacitor.
44	N.C.	No Connection. (Not connected internally)
45	AGND1	GND terminal (For analog circuit except 75 Ω driver).
46	RCLAMP	Analog Red signal clamp terminal.
47	AVCC1	The power supply terminal (For analog circuit except 75 Ω driver).
48	GCLAMP	Analog Green signal clamp terminal.

● Operation explanation for each block

- Clamp-Circuit (CLAMP)
This circuit sets the black (pedestal) level for the RGB signals eliminated DC level during the sync period (external sync is the low level). When the external sync is at the low level, the R, G, B data should not be input, since the dc input level is clamped at this timing. (BH7240AKV:00h, BH7236AF:0Vpp)
- RGB Matrix Circuit (MATRIX)
This circuit converts R, G and B signals to Y, R-Y and B-Y for color television.
- Balanced Modulation Circuit(BH7236AF:R-YMOD,G-YMOD BH7240AKV:CHROMAGEN)
Modulator circuit that modulates color-difference-signal (generated in RGB MATRIX) by 2 types of subcarrier that are 90 degrees different phase. The chrominance signal is generated by mixing these modulated signals.
- Mixed Circuit (YCMIX)
This circuit generates the composite video signal by combining the luminance (in the RGB MATRIX circuit) and the chrominance (in the balanced modulation circuit).
- TRAP Filter (external)
This filter eliminates the chrominance frequency component contained in luminance by connecting L (coil) and C (capacitor) to YTRAP terminal in series. Output impedance is about 2k Ω . This filter is effective only in a composite output (Vout), and does not influence luminance output (Yout). Refer to the "Application part selection method" regarding to the selection of L and C.
- 75 Ω Driver
Driver which can drive 75 Ω load directly. The 75 Ω driver outputs the regular level based on the video standard, when 75 Ω is connected as load. If 75 Ω is not connected as load, users may no longer take the accurate image, since the video signal output level is changed to a different one. Moreover, it is prohibited to use less than 75 Ω .

● I/O Equivalent circuit

©BH7236AF Input/Output Equivalent Circuit

Terminal Number	Terminal Name	Equivalent Circuit	Terminal Number	Terminal Name	Equivalent Circuit
2 3 4	RIN GIN BIN		10 7	SYNCIN NT/PAL	
6	SCIN		17	YTRAP	
23 22 21 20 16 15	ROUT GOUT BOUT VOUT YVOUT COUT		11	SYNC OUT	
8	BFP OUT				

©BH7240AKV Input/Output Equivalent Circuit

Terminal Number	Terminal Name	Equivalent Circuit	Terminal Number	Terminal Name	Equivalent Circuit
16-19 21-24 25-32 33-40	RDATA [7:0] GDATA [7:0] BDATA [7:0]		46 48 1	Red CLAMP Green CLAMP Blue CLAMP	
15	SCIN		13 14	NT/PAL SYNCIN	
10	YTRAP		43	VREF OUT	
3 4 5 6 7 8	ROUT GOUT BOUT YOUT COUT VOUT				

●Reference data I/O Characteristics (Only BH7236AF Condition: VCC1=VCC2=5.0V)

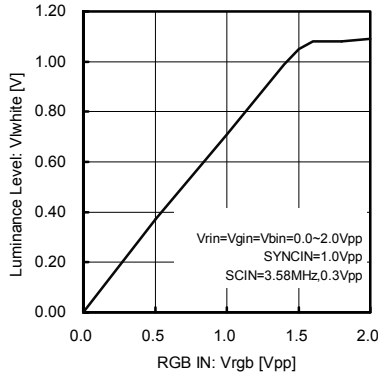

Fig.3 Yout (White) Characteristic

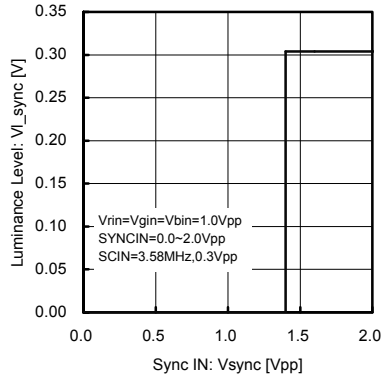

Fig.4 Yout (Sync) Characteristic

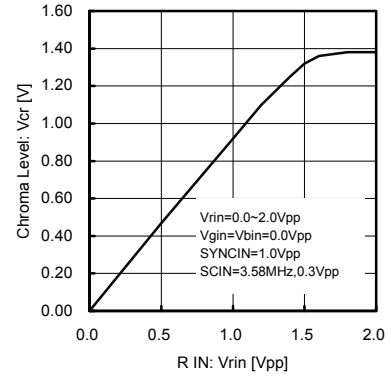

Fig.5 Cout (Red) Characteristic

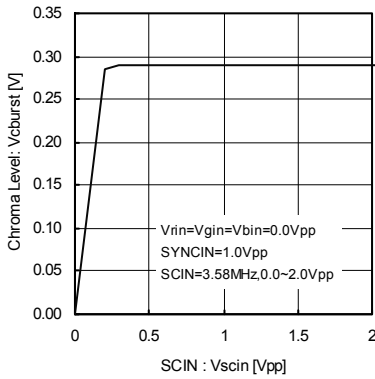

Fig.6 Cout (Burst) Characteristic

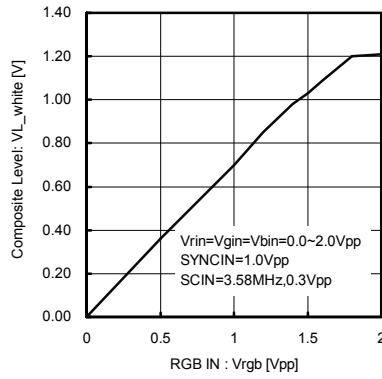

Fig.7 Vout Luminance (White) Characteristic

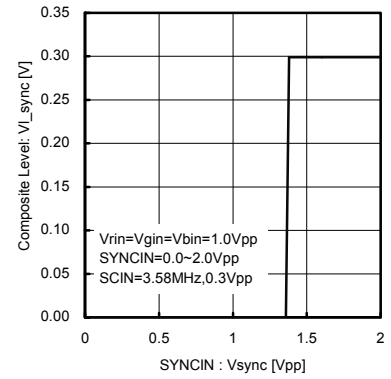

Fig.8 Vout Luminance (Sync) Characteristic

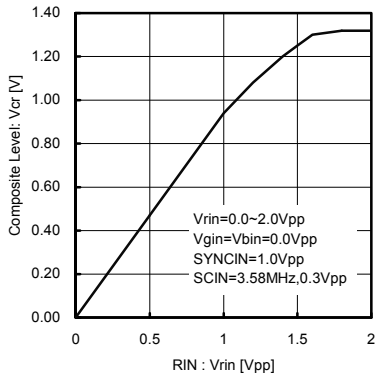

Fig.9 Vout Chroma (Red) Characteristic

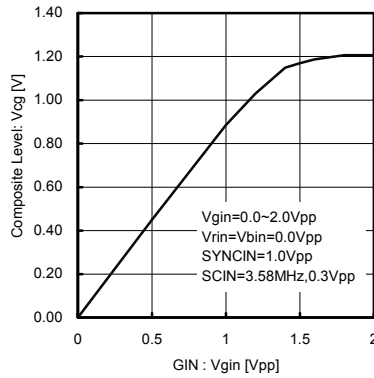

Fig.10 Vout Chroma (Green) Characteristic

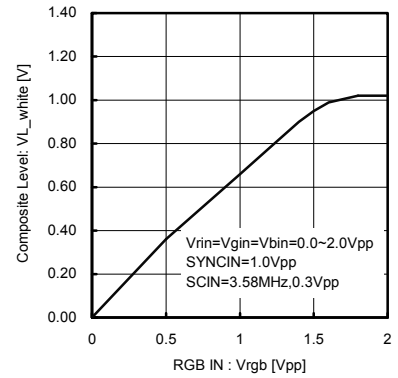

Fig.11 Vout Chroma (Blue) Characteristic

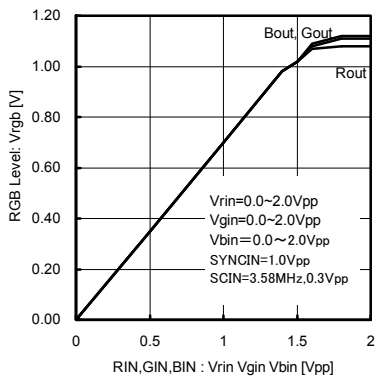

Fig.12 RGBout Characteristic

●Reference data Temperature Characteristics (BH7236AF, BH7240AKV)

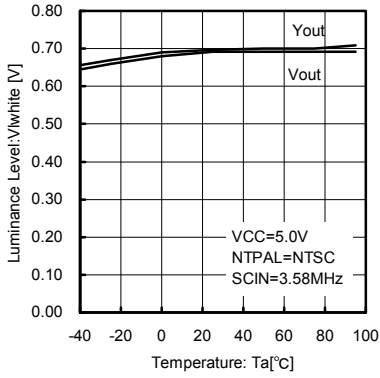

Fig. 13 Luminance (White) Characteristics

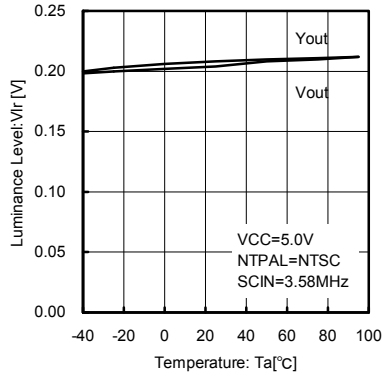

Fig. 14 Luminance (Red) Characteristics

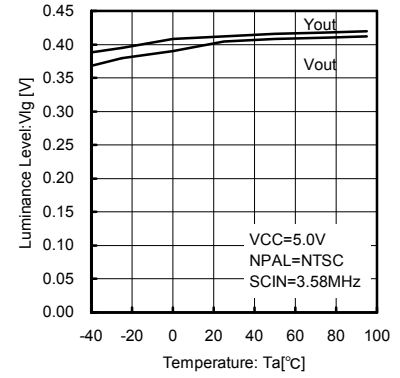

Fig. 15 Luminance (Green) Characteristics

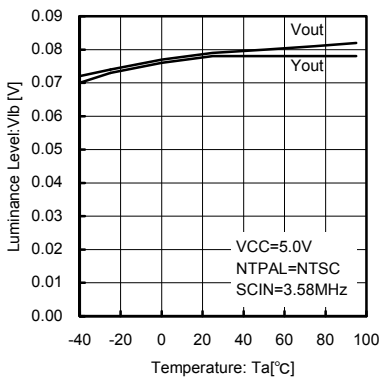

Fig. 16 Luminance (Blue) Characteristics

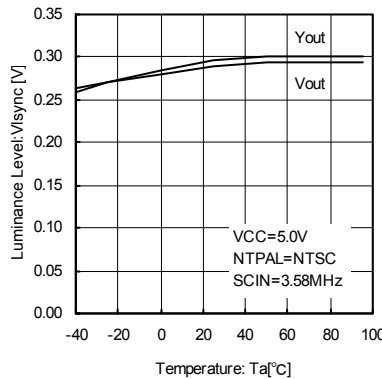

Fig. 17 Luminance (Sync) Characteristics

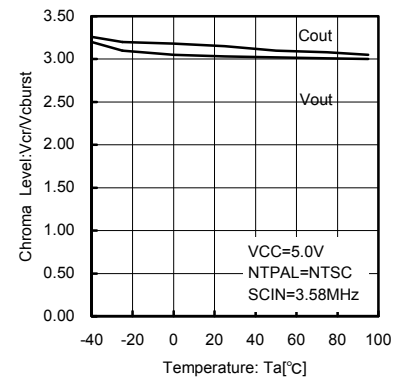

Fig. 18 Chroma (Red/Burst) Characteristics

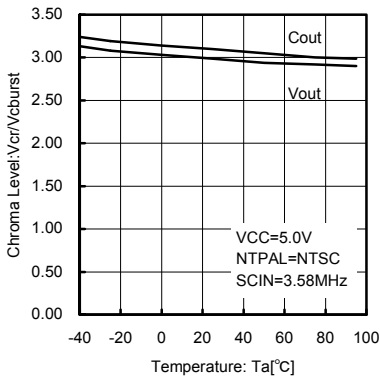

Fig. 19 Chroma (Green/Burst) Characteristics

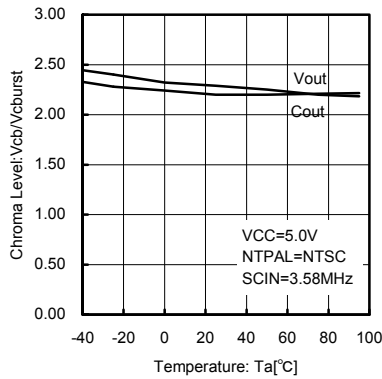

Fig. 20 Chroma (Blue/Burst) Characteristics

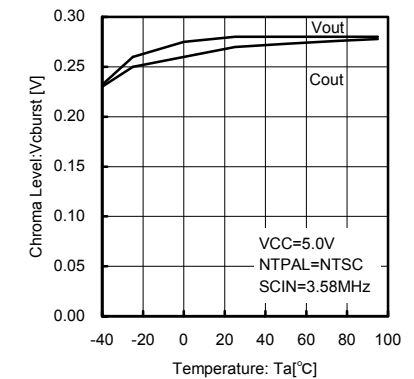

Fig. 21 Chroma (Burst) Characteristics

●Reference data Output Characteristics (BH7236AF, BH7240AKV)

[Condition SCIN:High=2.0V,Low=1.0V SYNCIN:High=2.0V, Low=1.0V]

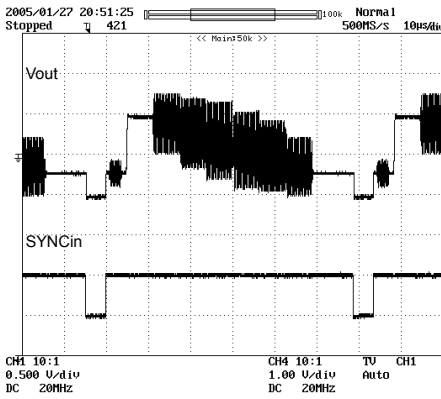

Fig.22 Vout, SYNCIN Waveform

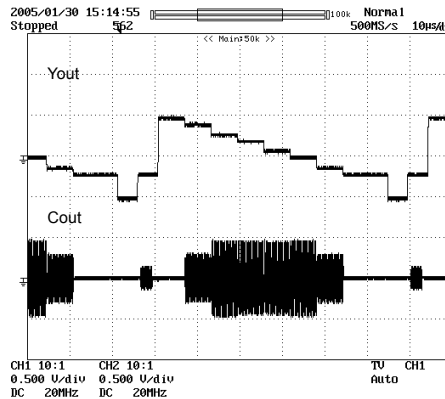

Fig.23 Yout, Cout Waveform

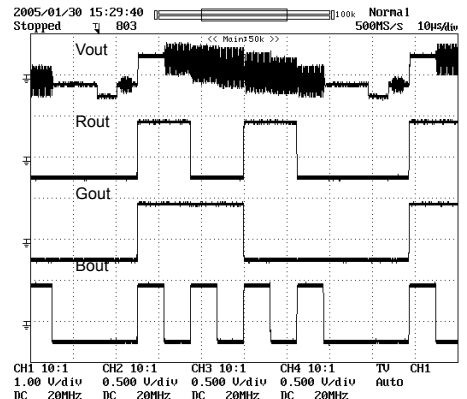

Fig.24 Vout,Rout,Gout,Bout Waveform

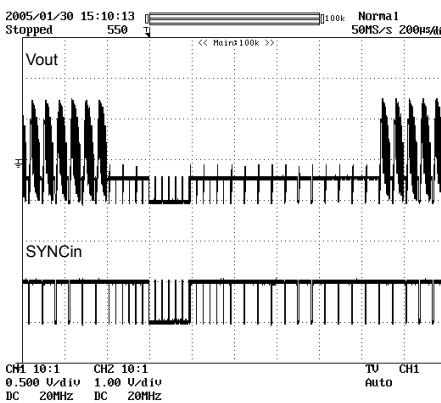

Fig.25 Blanking Section (NTSC ODD)

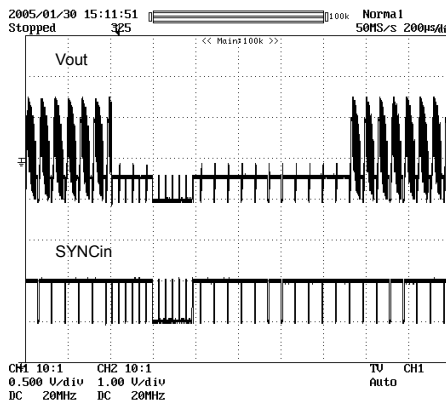

Fig.26 Blanking Section (NTSC EVEN)

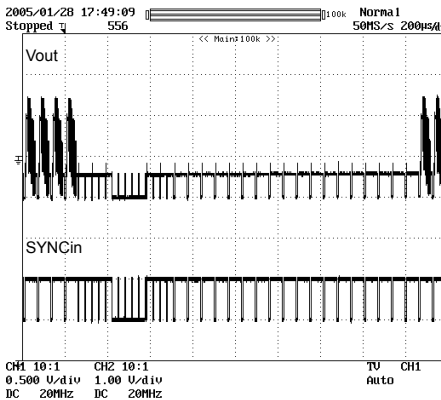

Fig.27 Blanking Section (PAL ODD)

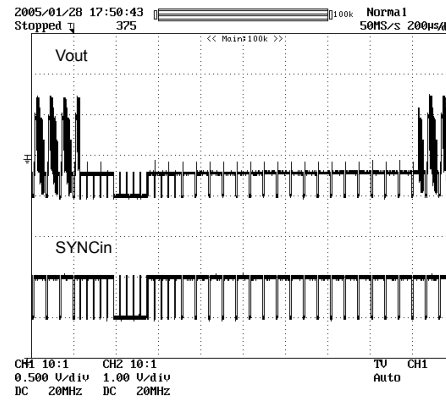

Fig.28 Blanking Section (PAL EVEN)

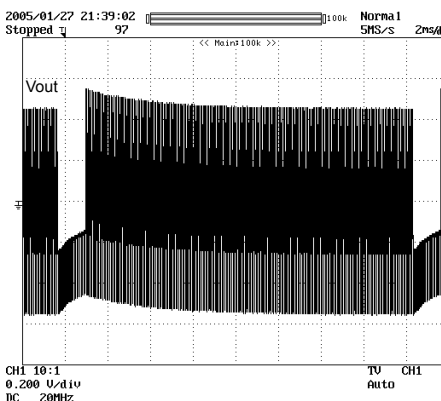

Fig.29 Vout (C=22µF)

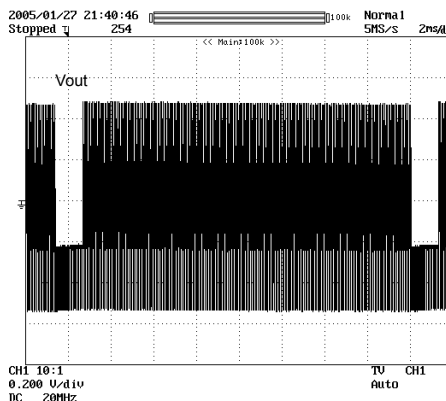

Fig.30 Vout (C=220µF)

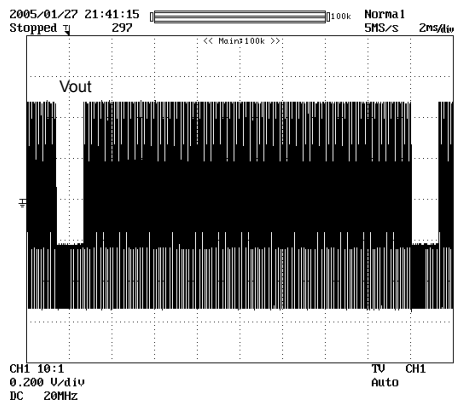

Fig.31 Vout (C=1000µF)

● Timing chart

- DAC, R, G, B Input Timing (only BH7240AKV)

Clock should be input at VCLK terminal (41 pins) by the system clock of DAC.
At the rising edge of this clock, RGB DATA is taken from inside the device.

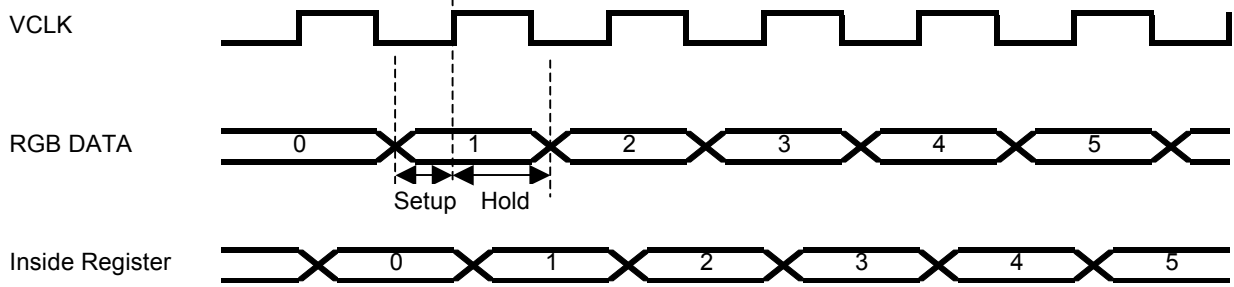

Fig.32 Input Timing of RGB, VCLK

- Data Input Timing, Composite, Sync Input Timing

Since BH7236AF and BH7240AKV do not have the mask function of data input, users do not input the data in the blanking terminal (reference to Fig 33-36). Instead, input the composite sync of the television standards to the SYNCIN terminal. The composite sync input needs to include the equalizing pulse in addition to H-Sync and V-Sync.

[In the case of NTSC]

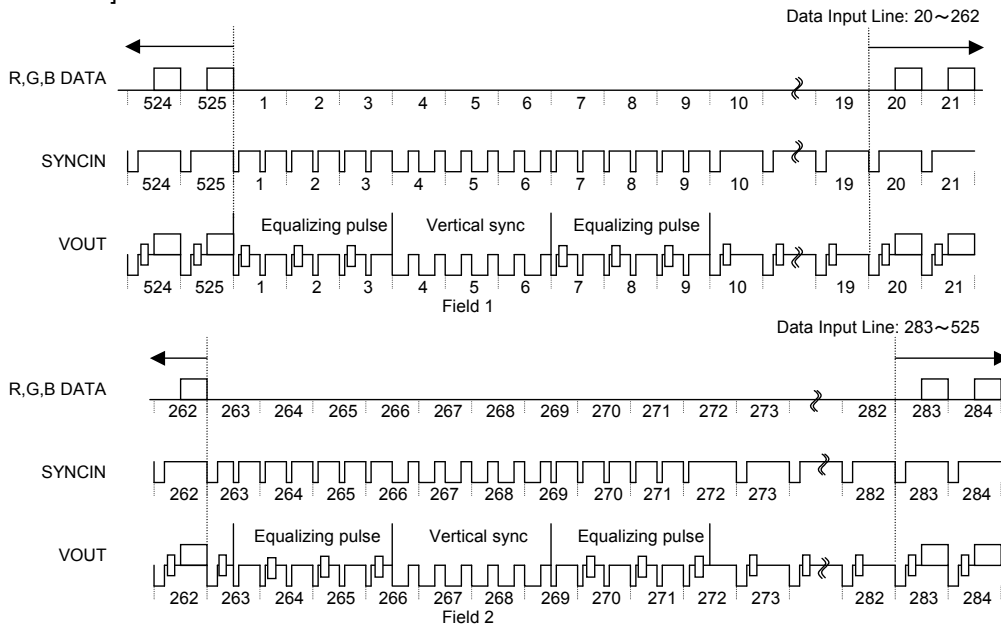

Fig.33 Data Input Range in the Field (NTSC)

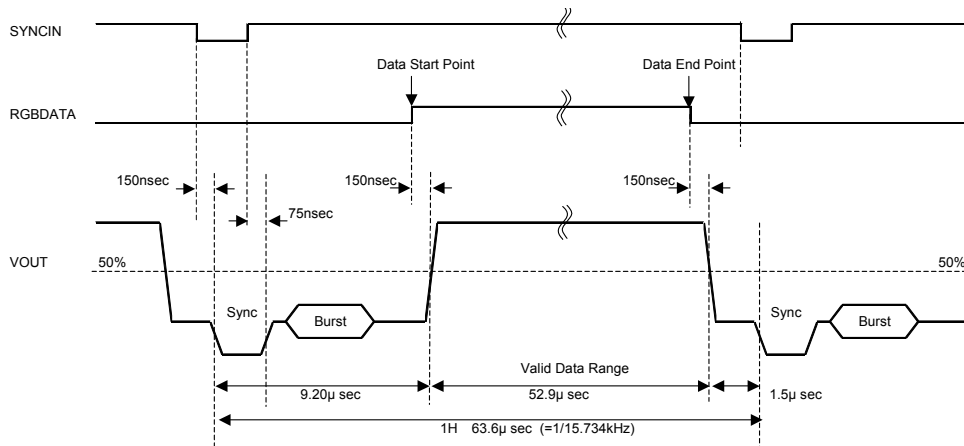

Fig.34 Data Input Range in 1H Line (NTSC)

[In the case of PAL]

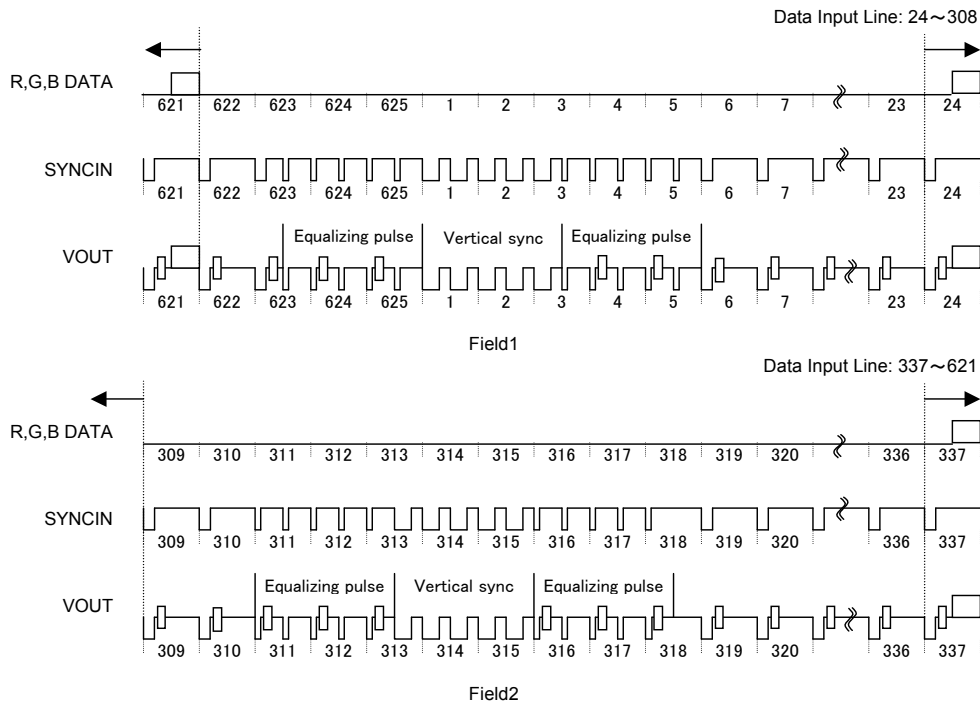

Fig.35 Data Input Range in the Field (PAL)

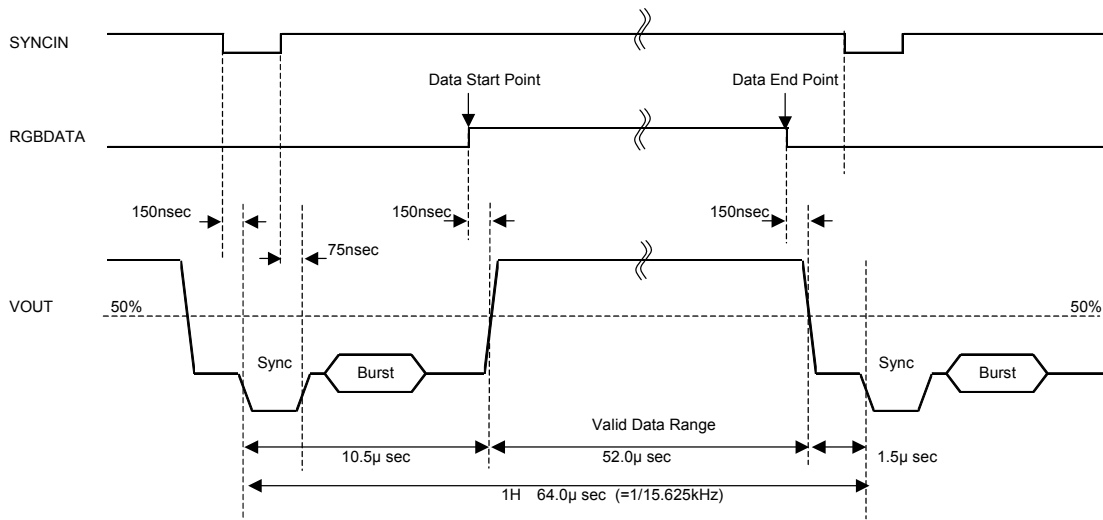

Fig.36 Data Input Range in 1H Line (PAL)

●Notes for use

1. **Absolute Maximum Ratings**
An excess in the absolute maximum ratings, such as supply voltage, temperature range of operating conditions, etc., can break down the devices, thus making impossible to identify breaking mode, such as a short circuit or an open circuit. If any over rated values will expect to exceed the absolute maximum ratings, consider adding circuit protection devices, such as fuses.
2. **Operating Voltage Range and Operating Temperature Range**
These conditions represent a range within which characteristics can be provided approximately as expected. The electrical characteristics are guaranteed under the conditions of each parameter.
3. **Reverse connection of power source connector**
Connecting the of power supply in reverse polarity can damage IC. Take precautions when connecting the power supply lines. An external direction diode can be added.
4. **Power supply line**
Design PCB layout pattern to provide low impedance GND and supply lines. To obtain a low noise ground and supply line, separate the ground section and supply lines of the digital and analog blocks. Furthermore, for all power supply terminals to ICs, connect a capacitor between the power supply and the GND terminal. When applying electrolytic capacitors in the circuit, note that capacitance characteristic values are reduced at low temperatures.
5. **GND voltage**
Ground-GND potential should maintain at the minimum ground voltage level. Furthermore, no terminals should be lower than the GND potential voltage including an electric transients.
6. **Inter-pin shorts and mounting errors**
Use caution when positioning the IC for mounting on printed circuit boards. The IC may be damaged if there is any connection error or if positive and ground power supply terminals are reversed. The IC may also be damaged if pins are shorted together or are shorted to other circuit's power lines.
7. **Operation in a strong electromagnetic field**
Use caution when using the IC in the presence of a strong electromagnetic field as doing so may cause the IC to malfunction.
8. **Inspection of set circuit board**
When testing the IC on an application board, connecting a capacitor to a pin with low impedance subjects the IC to stress. Always discharge capacitors after each process or step. Always turn the IC's power supply off before connecting it to, or removing it from a jig or fixture, during the inspection process. Ground the IC during assembly steps as an antistatic measure. Use similar precaution when transporting and storing the IC.
9. **Input terminals**
In terms of the construction of IC, parasitic elements are inevitably formed in relation to potential. The operation of the parasitic element can cause interference with circuit operation, thus resulting in a malfunction and then breakdown of the input terminal. Therefore, pay thorough attention not to handle the input terminals, such as to apply to the input terminals a voltage lower than the GND respectively, so that any parasitic element will operate. Furthermore, do not apply a voltage to the input terminals when no power supply voltage is applied to the IC. In addition, even if the power supply voltage is applied, apply to the input terminals a voltage lower than the power supply voltage or within the guaranteed value of electrical characteristics.
10. **Ground wiring patterns**
The power supply and ground lines must be as short and thick as possible to reduce line impedance. Fluctuating voltage on the power ground line may damage the device.
11. **External capacitor**
When using external ceramic capacitors, consider degradation in the nominal capacitance value due to DC bias and changes in the capacitance with temperature.

●Ordering part number

B	H
---	---

Part No.

7	2	3	6	A
---	---	---	---	---

Part No.
7236A
7240A

F	-	E	2
---	---	---	---

Package
F :SOP24
KV:VQFP48C

Packaging and forming specification
E2: Embossed tape and reel

SOP24

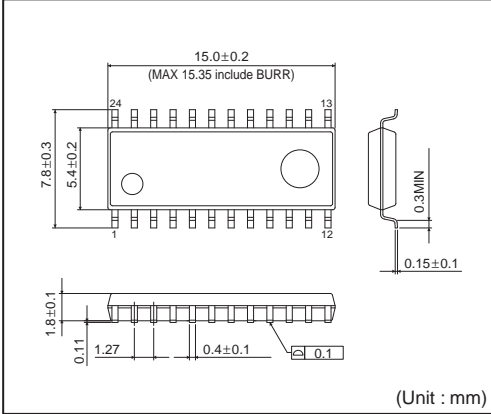

<Tape and Reel information>

Tape	Embossed carrier tape
Quantity	2000pcs
Direction of feed	E2 (The direction is the 1pin of product is at the upper left when you hold reel on the left hand and you pull out the tape on the right hand)

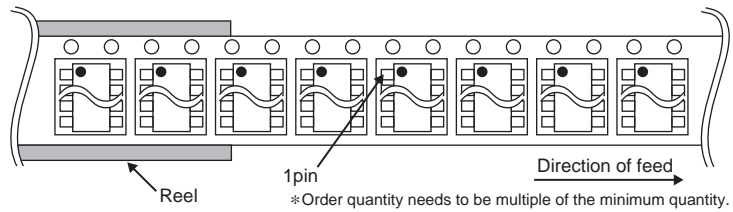

VQFP48C

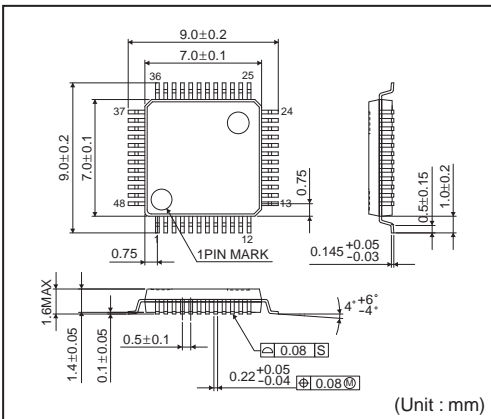

<Tape and Reel information>

Tape	Embossed carrier tape
Quantity	1500pcs
Direction of feed	E2 (The direction is the 1pin of product is at the upper left when you hold reel on the left hand and you pull out the tape on the right hand)

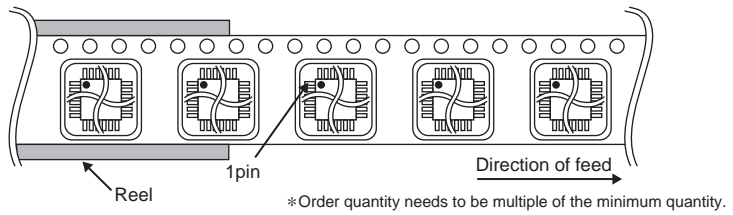

Notes

No copying or reproduction of this document, in part or in whole, is permitted without the consent of ROHM Co.,Ltd.

The content specified herein is subject to change for improvement without notice.

The content specified herein is for the purpose of introducing ROHM's products (hereinafter "Products"). If you wish to use any such Product, please be sure to refer to the specifications, which can be obtained from ROHM upon request.

Examples of application circuits, circuit constants and any other information contained herein illustrate the standard usage and operations of the Products. The peripheral conditions must be taken into account when designing circuits for mass production.

Great care was taken in ensuring the accuracy of the information specified in this document. However, should you incur any damage arising from any inaccuracy or misprint of such information, ROHM shall bear no responsibility for such damage.

The technical information specified herein is intended only to show the typical functions of and examples of application circuits for the Products. ROHM does not grant you, explicitly or implicitly, any license to use or exercise intellectual property or other rights held by ROHM and other parties. ROHM shall bear no responsibility whatsoever for any dispute arising from the use of such technical information.

The Products specified in this document are intended to be used with general-use electronic equipment or devices (such as audio visual equipment, office-automation equipment, communication devices, electronic appliances and amusement devices).

The Products specified in this document are not designed to be radiation tolerant.

While ROHM always makes efforts to enhance the quality and reliability of its Products, a Product may fail or malfunction for a variety of reasons.

Please be sure to implement in your equipment using the Products safety measures to guard against the possibility of physical injury, fire or any other damage caused in the event of the failure of any Product, such as derating, redundancy, fire control and fail-safe designs. ROHM shall bear no responsibility whatsoever for your use of any Product outside of the prescribed scope or not in accordance with the instruction manual.

The Products are not designed or manufactured to be used with any equipment, device or system which requires an extremely high level of reliability the failure or malfunction of which may result in a direct threat to human life or create a risk of human injury (such as a medical instrument, transportation equipment, aerospace machinery, nuclear-reactor controller, fuel-controller or other safety device). ROHM shall bear no responsibility in any way for use of any of the Products for the above special purposes. If a Product is intended to be used for any such special purpose, please contact a ROHM sales representative before purchasing.

If you intend to export or ship overseas any Product or technology specified herein that may be controlled under the Foreign Exchange and the Foreign Trade Law, you will be required to obtain a license or permit under the Law.





Thank you for your accessing to ROHM product informations.
More detail product informations and catalogs are available, please contact us.

ROHM Customer Support System

<http://www.rohm.com/contact/>

Looking for pricing, stock, or lifecycle information?

Click below to explore more details on WIN SOURCE:

-  [View BH7240AKV-E2 on WIN SOURCE](#)
-  [Rohm Semiconductor](#) Information

Optimize Your Supply Chain with WIN SOURCE Solutions

-  Global Sourcing Solution
-  Obsolete Management
-  Cost Control Management
-  Shortage Management
-  Alternative Solution
-  Excess Inventory Management