

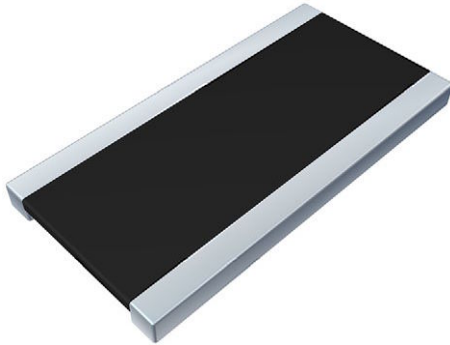

**THE DATASHEET OF
WSL10203L000FEA**



Power Metal Strip® Resistors, Wide Terminal, Low Inductance (< 1 nH), Surface-Mount



LINKS TO ADDITIONAL RESOURCES



FEATURES

- Wide side terminal construction that yields high power to foot print size ratio (2 W in 1020 and 1 W in 0612 package)
- All welded construction of the Power Metal Strip® resistors are ideal for all types of current sensing, voltage division and pulse applications
- Proprietary processing technique produces low resistance values (down to 0.00075 Ω)
- Sulfur resistance by construction that is unaffected by high sulfur environments
- Very low inductance < 1 nH
- Low thermal EMF (< 3 μV/°C)
- AEC-Q200 qualified ⁽¹⁾
- Material categorization: for definitions of compliance please see www.vishay.com/doc?99912



Notes

- This datasheet provides information about parts that are RoHS-compliant and / or parts that are non RoHS-compliant. For example, parts with lead (Pb) terminations are not RoHS-compliant. Please see the information / tables in this datasheet for details
- ⁽¹⁾ Flame retardance test may not be applicable to some resistor technologies

STANDARD ELECTRICAL SPECIFICATIONS					
GLOBAL MODEL	SIZE	POWER RATING $P_{70\text{ }^\circ\text{C}}$ W	TOLERANCE ± %	RESISTANCE VALUE RANGE Ω	WEIGHT (typical) g/1000 pieces
WSL0612 ⁽¹⁾	0612	1.0	1.0, 5.0	0.75m to 5m	8.5
WSL1020 ⁽¹⁾	1020	2.0	0.5, 1.0, 5.0	1m to 6m	38.74

Note

- ⁽¹⁾ Qualified to AEC-Q200 rev. D

GLOBAL PART NUMBER INFORMATION																
Global Part Numbering Example: WSL10206L000FEA (visit www.vishay.net Vishay Dale parts numbering manual for all options)																
W	S	L	1	0	2	0	6	L	0	0	0	F	E	A		
GLOBAL MODEL (7 digits)			RESISTANCE VALUE ⁽¹⁾ (5 digits)			TOLERANCE CODE (1 digit)		PACKAGING CODE ⁽²⁾ (2 digits)			SPECIAL ⁽³⁾ (up to 2 digits) (dash number) From 1 to 99 as applicable					
WSL0612 WSL1020			L = mΩ* 1L000 = 0.001 Ω 2L000 = 0.002 Ω 3L000 = 0.003 Ω 4L000 = 0.004 Ω 5L000 = 0.005 Ω 6L000 = 0.006 Ω * Use "L" for resistance values < 0.01 Ω			D = ± 0.5 % F = ± 1.0 % J = ± 5.0 %		EA = lead (Pb)-free, tape / reel								

Notes

- Per PCN-DR-00009-2022-REV-0, WSL marking will be removed effective March 1st, 2023
- ⁽¹⁾ WSL marking (www.vishay.com/doc?30327); WSL decade values (www.vishay.com/doc?30117)
- ⁽²⁾ EB (lead (Pb)-free) is a non-standard packaging code designated for 1000 piece reels. The non-standard packaging code is identical to our standard EA (lead (Pb)-free), except that it has a package quantity of 1000 pieces
- ⁽³⁾ Follow link for customization capabilities: www.vishay.com/doc?48163

TECHNICAL SPECIFICATIONS			
PARAMETER	UNIT	RESISTOR CHARACTERISTICS	
		WSL0612	WSL1020
Component temperature coefficient (including terminal) ⁽¹⁾	ppm/°C	+250 ⁽⁴⁾ for 0.75 mΩ and 1.9 mΩ	+100 ppm/°C to -10 ppm/°C for 1.5 mΩ to 6 mΩ
		+150 ⁽⁴⁾ for 2 mΩ to 6 mΩ	+170 ppm/°C to -20 ppm/°C for < 1.5 mΩ
Element TCR ⁽²⁾	ppm/°C	< 20	
Operating temperature range	°C	-65 to +170	
Maximum working voltage ⁽³⁾	V	$(P \times R)^{1/2}$	

Notes

- “Temperature Coefficient of Resistance for Current Sensing” white paper: www.vishay.com/doc?30405
- (1) Component TCR - total TCR that includes the TCR effects of the resistor element and the copper terminal
- (2) Element TCR - only applies to the alloy used for the resistor element; refer to item 1 in the construction illustration on the following page
- (3) Maximum working voltage - the WSL is not voltage sensitive, but is limited by power / energy dissipation and is also not ESD sensitive
- (4) Typical TCR is positive, for more details contact factory

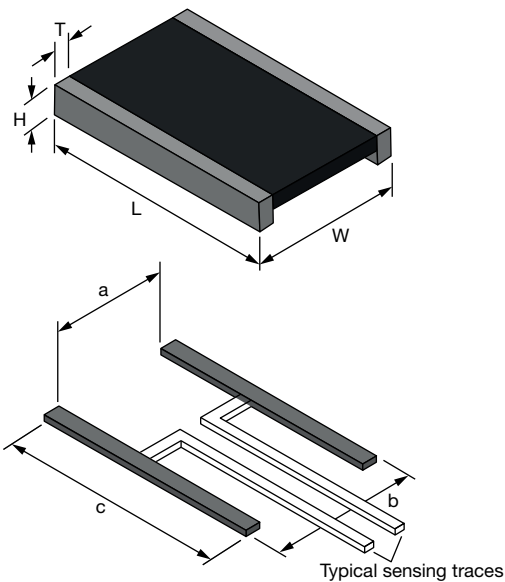
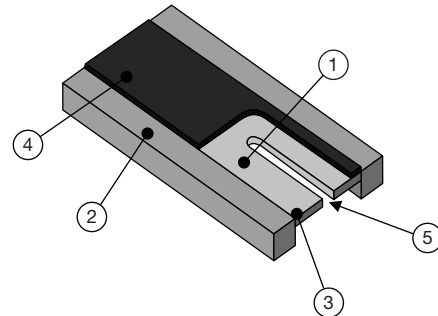
DIMENSIONS

WELDED CONSTRUCTION

- ① Resistive element: nickel-chrome or manganese-copper alloy with low TCR (< 20 ppm/°C)
- ② Terminal: solid copper with 100 % Sn finish 100 % Sn (100 μ" min.) with 100 % Ni (20 μ" min.) under layer finish
- ③ Terminal / element weld (electron beam weld)
- ④ High temperature encapsulant: "siliconized polyester" coating material
- ⑤ Laser calibration

Notes

- 3D models available: www.vishay.com/doc?30348
- Surface-mount solder profile recommendations: www.vishay.com/doc?31052

MODEL	DIMENSIONS in inches (millimeters)			
	L	W	H	T
WSL0612	0.120 ± 0.005 (3.05 ± 0.127)	0.060 ± 0.005 (1.50 ± 0.127)	0.018 ± 0.010 (0.457 ± 0.254)	0.015 ± 0.010 (0.381 ± 0.254)
WSL1020	0.200 ± 0.005 (5.08 ± 0.127)	0.100 ± 0.010 (2.54 ± 0.254)	0.025 ± 0.005 (0.635 ± 0.127)	0.022 ± 0.008 (0.558 ± 0.203)

MODEL	SOLDER PAD DIMENSIONS in inches (millimeters)		
	a	b	c
WSL0612	0.030 (0.76)	0.078 (1.98)	0.134 (3.40)
WSL1020	0.039 (1.00)	0.138 (3.50)	0.222 (5.65)

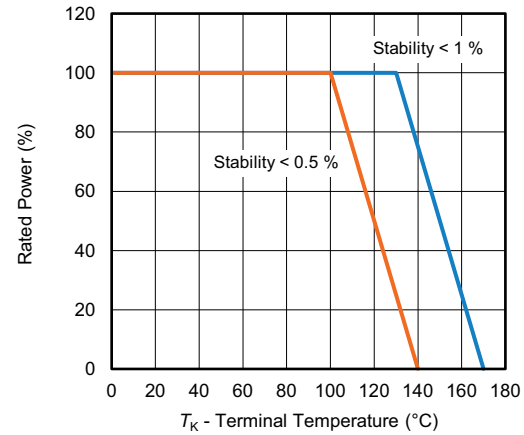
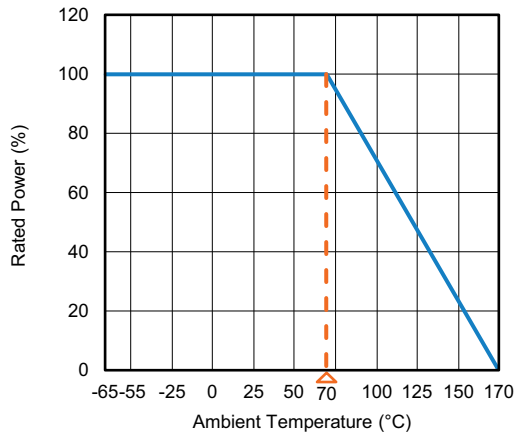
DERATING

PULSE CAPABILITY

www.vishay.com/en/resistors/joulewizard/

PERFORMANCE		
TEST	CONDITIONS OF TEST	TEST LIMITS
Thermal shock	-55 °C to +150 °C, 2000 cycles, 15 min at each extreme	± 0.5 %
Low temperature operation	-65 °C for 24 h	± 0.5 %
High temperature exposure	2000 h at +170 °C	± 1.0 %
Bias humidity	+85 °C, 85 % RH, 10 % bias, 1000 h	± 0.5 %
Mechanical shock	100 g's for 6 ms, 5 pulses	± 0.5 %
Vibration	Frequency varied 10 Hz to 2000 Hz in 1 min, 3 directions, 12 h	± 0.5 %
Load life	2000 h at 70 °C, 1.5 h "ON", 0.5 h "OFF"	± 1.0 %
Resistance to solder heat	+260 °C solder, 10 s to 12 s dwell, 25 mm/s emergence	± 0.5 %
Moisture resistance	MIL-STD-202, method 106, 0 % power, 7b not required	± 0.5 %

PACKAGING				
MODEL	REEL			
	TAPE WIDTH	DIAMETER	PIECES/REEL	CODE
WSL0612	8 mm / embossed plastic	178 mm / 7"	4000	EA
WSL1020	12 mm / embossed plastic	178 mm / 7"	4000	EA

Notes

- Embossed carrier tape per EIA-481-2
- (1) Additional packaging details at www.vishay.com/doc?20051



LINKS TO RELATED DOCUMENTS	
SELECTOR GUIDE	
Overview of Automotive Grade Products	www.vishay.com/doc?49924
TECHNICAL NOTES	
SMD Current Sense: AEC-Q200 vs. Vishay Qualification	www.vishay.com/doc?30416
MIL-PRF vs. AEC-Q200: Do You Know What You Are Getting?	www.vishay.com/doc?11000
WHITE PAPER	
Thermal Management for Surface-Mount Devices	www.vishay.com/doc?30380
Temperature Coefficient of Resistance for Current Sensing	www.vishay.com/doc?30405



Disclaimer

ALL PRODUCT, PRODUCT SPECIFICATIONS AND DATA ARE SUBJECT TO CHANGE WITHOUT NOTICE TO IMPROVE RELIABILITY, FUNCTION OR DESIGN OR OTHERWISE.

Vishay Intertechnology, Inc., its affiliates, agents, and employees, and all persons acting on its or their behalf (collectively, "Vishay"), disclaim any and all liability for any errors, inaccuracies or incompleteness contained in any datasheet or in any other disclosure relating to any product.

Vishay makes no warranty, representation or guarantee regarding the suitability of the products for any particular purpose or the continuing production of any product. To the maximum extent permitted by applicable law, Vishay disclaims (i) any and all liability arising out of the application or use of any product, (ii) any and all liability, including without limitation special, consequential or incidental damages, and (iii) any and all implied warranties, including warranties of fitness for particular purpose, non-infringement and merchantability.

Statements regarding the suitability of products for certain types of applications are based on Vishay's knowledge of typical requirements that are often placed on Vishay products in generic applications. Such statements are not binding statements about the suitability of products for a particular application. It is the customer's responsibility to validate that a particular product with the properties described in the product specification is suitable for use in a particular application. Parameters provided in datasheets and / or specifications may vary in different applications and performance may vary over time. All operating parameters, including typical parameters, must be validated for each customer application by the customer's technical experts. Product specifications do not expand or otherwise modify Vishay's terms and conditions of purchase, including but not limited to the warranty expressed therein.

Hyperlinks included in this datasheet may direct users to third-party websites. These links are provided as a convenience and for informational purposes only. Inclusion of these hyperlinks does not constitute an endorsement or an approval by Vishay of any of the products, services or opinions of the corporation, organization or individual associated with the third-party website. Vishay disclaims any and all liability and bears no responsibility for the accuracy, legality or content of the third-party website or for that of subsequent links.

Vishay products are not designed for use in life-saving or life-sustaining applications or any application in which the failure of the Vishay product could result in personal injury or death unless specifically qualified in writing by Vishay. Customers using or selling Vishay products not expressly indicated for use in such applications do so at their own risk. Please contact authorized Vishay personnel to obtain written terms and conditions regarding products designed for such applications.

No license, express or implied, by estoppel or otherwise, to any intellectual property rights is granted by this document or by any conduct of Vishay. Product names and markings noted herein may be trademarks of their respective owners.

Looking for pricing, stock, or lifecycle information?

Click below to explore more details on WIN SOURCE:

 [View WSL10203L000FEA on WIN SOURCE](#)

 [Vishay Information](#)

Optimize Your Supply Chain with WIN SOURCE Solutions

-  Global Sourcing Solution
-  Obsolete Management
-  Cost Control Management
-  Shortage Management
-  Alternative Solution
-  Excess Inventory Management