

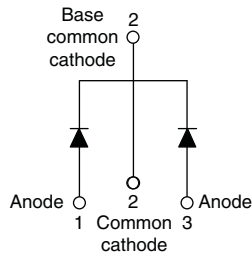

**THE DATASHEET OF  
VS-20CTQ150PBF**



## Schottky Rectifier, 2 x 10 A

**TO-220AB**

### FEATURES

- 175 °C  $T_J$  operation
- Low forward voltage drop
- High frequency operation
- High purity, high temperature epoxy encapsulation for enhanced mechanical strength and moisture resistance
- Guard ring for enhanced ruggedness and long term reliability
- Compliant to RoHS Directive 2002/95/EC
- Designed and qualified according to JEDEC-JESD47
- Halogen-free according to IEC 61249-2-21 definition (-N3 only)



| PRODUCT SUMMARY |                |
|-----------------|----------------|
| Package         | TO-220AB       |
| $I_{F(AV)}$     | 2 x 10 A       |
| $V_R$           | 150 V          |
| $V_F$ at $I_F$  | 0.66 V         |
| $I_{RM}$ max.   | 5 mA at 125 °C |
| $T_J$           | 175 °C         |
| Diode variation | Common cathode |
| $E_{AS}$        | 2.45 mJ        |

### DESCRIPTION

The center tap Schottky rectifier series has been optimized for low reverse leakage at high temperature. The proprietary barrier technology allows for reliable operation up to 175 °C junction temperature. Typical applications are in switching power supplies, converters, freewheeling diodes, and reverse battery protection.

| MAJOR RATINGS AND CHARACTERISTICS |  |             |       |
|-----------------------------------|--|-------------|-------|
| SYMBOL                            | CHARACTERISTICS                                | VALUES      | UNITS |
| $I_{F(AV)}$                       | Rectangular waveform                           | 20          | A     |
| $V_{RRM}$                         |  | 150         | V     |
| $I_{FSM}$                         | $t_p = 5 \mu s$ sine                           | 1030        | A     |
| $V_F$                             | 10 $A_{pk}$ , $T_J = 125 \text{ °C}$ (per leg) | 0.66        | V     |
| $T_J$                             | Range  | - 55 to 175 | °C    |

| VOLTAGE RATINGS                      |           |                |                |       |
|--------------------------------------|-----------|----------------|----------------|-------|
| PARAMETER                            | SYMBOL    | VS-20CTQ150PbF | VS-20CTQ150-N3 | UNITS |
| Maximum DC reverse voltage           | $V_R$     | 150            | 150            | V     |
| Maximum working peak reverse voltage | $V_{RWM}$ |                |                |       |

| ABSOLUTE MAXIMUM RATINGS  |             |   |   |         |       |
|---|-------------|---|---|---------|-------|
| PARAMETER   | SYMBOL      | TEST CONDITIONS   |   | VALUES  | UNITS |
| Maximum average forward current<br>See fig. 5                             | $I_{F(AV)}$ | 50 % duty cycle at $T_C = 154 \text{ °C}$ , rectangular waveform  |   | 10      | A     |
|   |             |   |   | per leg |       |
| Maximum peak one cycle non-repetitive surge current per leg<br>See fig. 7 | $I_{FSM}$   | 5 $\mu s$ sine or 3 $\mu s$ rect. pulse   | Following any rated load condition and with rated $V_{RRM}$ applied | 1030    | A     |
|   |             | 10 ms sine or 6 ms rect. pulse  |   | 180     |       |
| Non-repetitive avalanche energy per leg                                   | $E_{AS}$    | $T_J = 25 \text{ °C}$ , $I_{AS} = 0.7 \text{ A}$ , $L = 10 \text{ mH}$  |   | 2.45    | mJ    |
| Repetitive avalanche current per leg                                      | $I_{AR}$    | Current decaying linearly to zero in 1 $\mu s$<br>Frequency limited by $T_J$ maximum $V_A = 1.5 \times V_R$ typical |   | 0.7     | A     |



| ELECTRICAL SPECIFICATIONS                             |                |   |                                   |      |        |                  |
|---|----------------|---|-----------------------------------|------|--------|------------------|
| PARAMETER   | SYMBOL         | TEST CONDITIONS   |                                   | TYP. | MAX.   | UNITS            |
| Maximum forward voltage drop per leg<br>See fig. 1    | $V_{FM}^{(1)}$ | 10 A  | $T_J = 25\text{ }^\circ\text{C}$  | 0.80 | 0.88   | V                |
|   |                | 20 A  |                                   | 0.90 | 1.0    |                  |
|   |                | 10 A  | $T_J = 125\text{ }^\circ\text{C}$ | 0.63 | 0.66   |                  |
|   |                | 20 A  |                                   | 0.73 | 0.77   |                  |
| Maximum reverse leakage current per leg<br>See fig. 2 | $I_{RM}$       | $T_J = 25\text{ }^\circ\text{C}$  | $V_R = \text{Rated } V_R$         | 3.0  | 25     | $\mu\text{A}$    |
|   |                | $T_J = 125\text{ }^\circ\text{C}$   |                                   | 2.7  | 5.0    | mA               |
| Typical junction capacitance per leg                  | $C_T$          | $V_R = 5\text{ }V_{DC}$ (test signal range 100 kHz to 1 MHz) $25\text{ }^\circ\text{C}$ |                                   | -    | 280    | pF               |
| Typical series inductance per leg                     | $L_S$          | Measured lead to lead 5 mm from package body  |                                   | -    | 8.0    | nH               |
| Maximum voltage rate of change                        | dV/dt          | Rated $V_R$   |                                   | -    | 10 000 | V/ $\mu\text{s}$ |

**Note**

(1) Pulse width < 300  $\mu\text{s}$ , duty cycle < 2 %

| THERMAL - MECHANICAL SPECIFICATIONS                      |                |  |             |                        |
|--|----------------|--|-------------|------------------------|
| PARAMETER  | SYMBOL         | TEST CONDITIONS  | VALUES      | UNITS                  |
| Maximum junction and storage temperature range           | $T_J, T_{Stg}$ |  | - 55 to 175 | $^\circ\text{C}$       |
| Maximum thermal resistance, junction to case per leg     | $R_{thJC}$     | DC operation   | 2.0         | $^\circ\text{C/W}$     |
| Maximum thermal resistance, junction to case per package |                |  | 1.0         |                        |
| Typical thermal resistance, case to heatsink             | $R_{thCS}$     | Mounting surface, smooth and greased (Only for TO-220) | 0.50        |                        |
| Approximate weight                                       |                |  | 2           | g                      |
|  |                |  | 0.07        | oz.                    |
| Mounting torque  | minimum        |  | 6 (5)       | kgf · cm<br>(lbf · in) |
|  | maximum        |  | 12 (10)     |                        |
| Marking device   |                | Case style TO-220AB                                    | 20CTQ150    |                        |

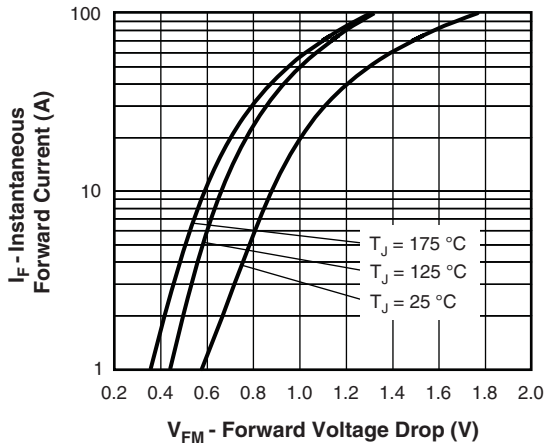

Fig. 1 - Maximum Forward Voltage Drop Characteristics (Per Leg)

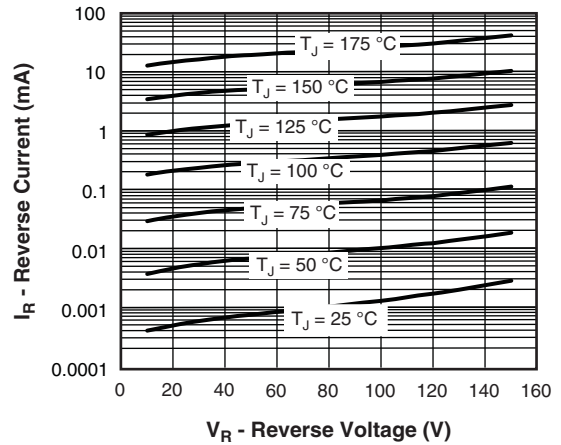

Fig. 2 - Typical Values of Reverse Current vs. Reverse Voltage (Per Leg)

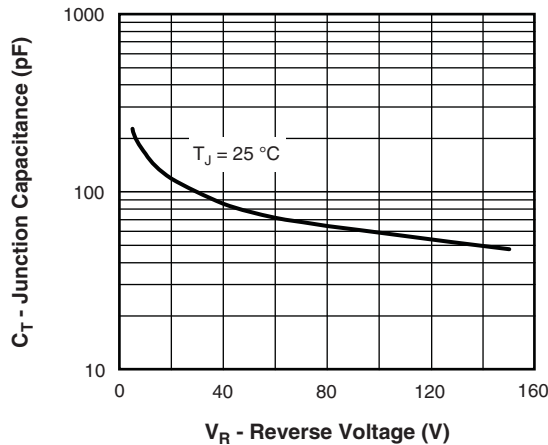

Fig. 3 - Typical Junction Capacitance vs. Reverse Voltage (Per Leg)

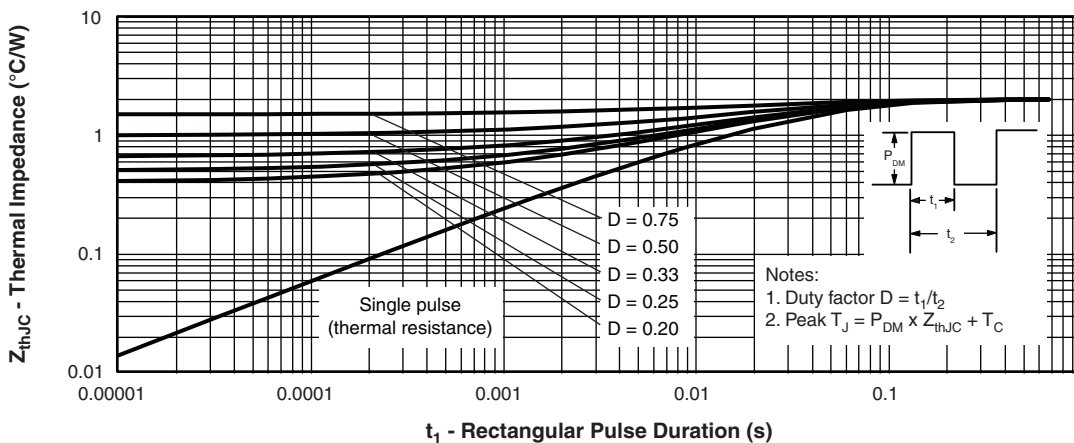

Fig. 4 - Maximum Thermal Impedance  $Z_{thJC}$  Characteristics (Per Leg)

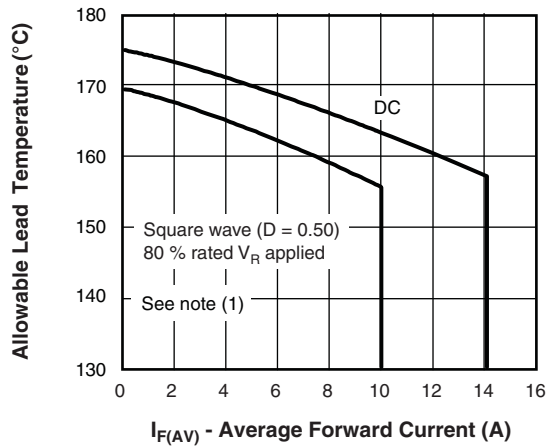

Fig. 5 - Maximum Average Forward Current vs. Allowable Lead Temperature

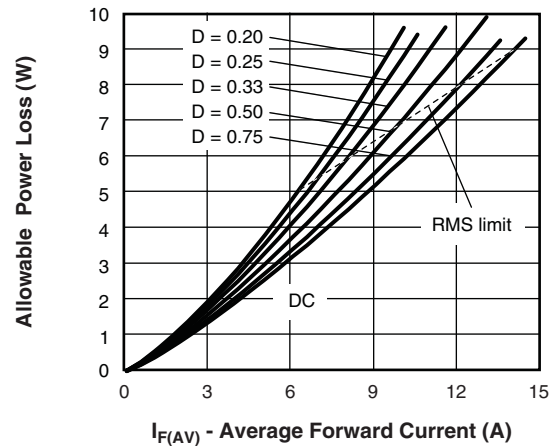

Fig. 6 - Maximum Average Forward Dissipation vs. Average Forward Current

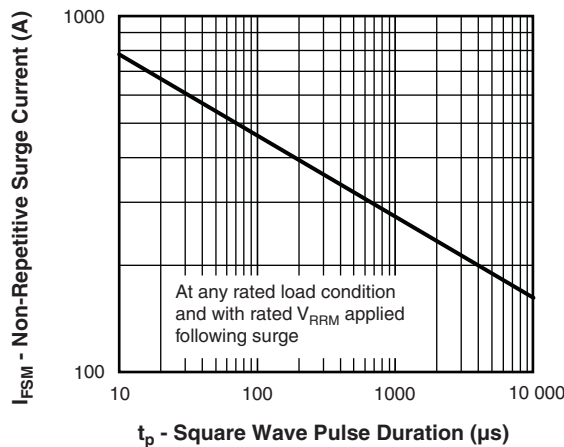

Fig. 7 - Maximum Peak Surge Forward Current vs. Pulse Duration

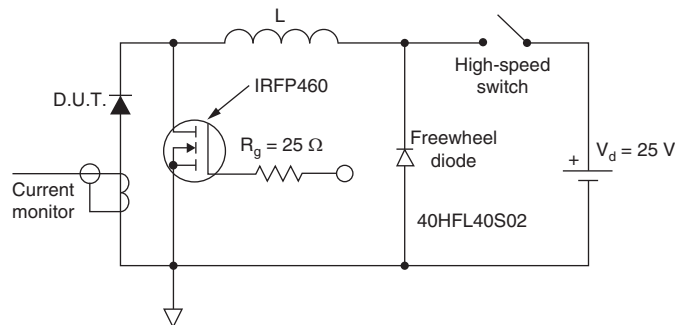

Fig. 8 - Unclamped Inductive Test Circuit

**Note**

- (1) Formula used:  $T_C = T_J - (Pd + Pd_{REV}) \times R_{thJC}$ ;
- $Pd$  = Forward power loss =  $I_{F(AV)} \times V_{FM}$  at  $(I_{F(AV)}/D)$  (see fig. 6);
- $Pd_{REV}$  = Inverse power loss =  $V_{R1} \times I_R (1 - D)$ ;  $I_R$  at  $V_{R1} = 80\%$  rated  $V_R$



## ORDERING INFORMATION TABLE

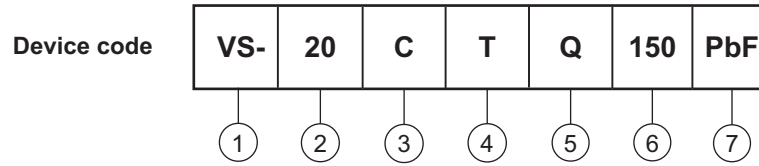

- 1** - Vishay Semiconductors product
- 2** - Current rating (20 = 20 A)
- 3** - Circuit configuration:  
C = Common cathode
- 4** - Package:  
T = TO-220
- 5** - Schottky "Q" series
- 6** - Voltage ratings (150 = 150 A)
- 7** - Environmental digit
  - PbF = Lead (Pb)-free and RoHS compliant
  - -N3 = Halogen-free, RoHS compliant, and totally lead (Pb)-free

| ORDERING INFORMATION (Example) |                  |                        |                         |
|--------------------------------|------------------|------------------------|-------------------------|
| PREFERRED P/N                  | QUANTITY PER T/R | MINIMUM ORDER QUANTITY | PACKAGING DESCRIPTION   |
| VS-20CTQ150PbF                 | 50               | 1000                   | Antistatic plastic tube |
| VS-20CTQ150-N3                 | 50               | 1000                   | Antistatic plastic tube |

| LINKS TO RELATED DOCUMENTS |   |
|----------------------------|---|
| Dimensions                 | <a href="http://www.vishay.com/doc?95222">www.vishay.com/doc?95222</a>              |
| Part marking information   | TO-220AB PbF <a href="http://www.vishay.com/doc?95225">www.vishay.com/doc?95225</a> |
|                            | TO-220AB -N3 <a href="http://www.vishay.com/doc?95028">www.vishay.com/doc?95028</a> |

## TO-220AB

### DIMENSIONS in millimeters and inches

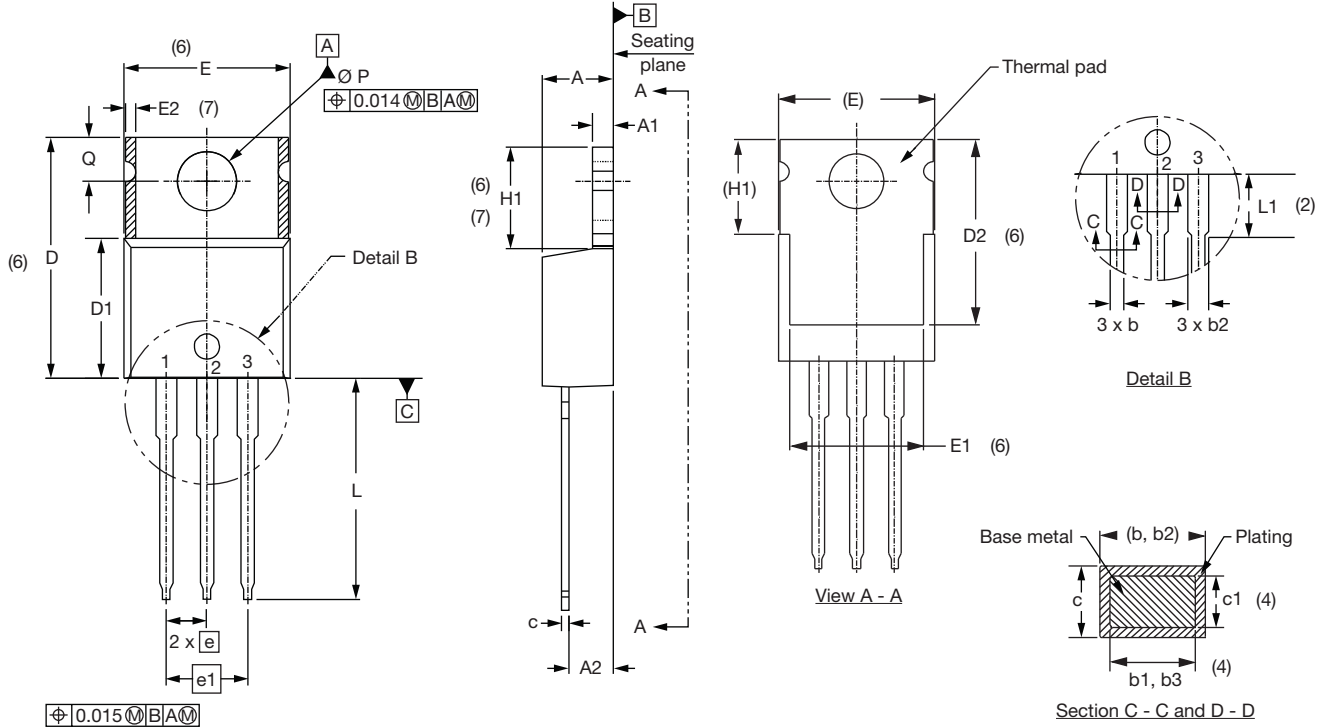

#### Lead assignments

#### Diodes

1. - Anode/open
2. - Cathode
3. - Anode

Conforms to JEDEC outline TO-220AB

| SYMBOL | MILLIMETERS |       | INCHES     |       | NOTES |
|--------|-------------|-------|------------|-------|-------|
|        | MIN.        | MAX.  | MIN.       | MAX.  |       |
| A      | 4.25        | 4.65  | 0.167      | 0.183 |       |
| A1     | 1.14        | 1.40  | 0.045      | 0.055 |       |
| A2     | 2.56        | 2.92  | 0.101      | 0.115 |       |
| b      | 0.69        | 1.01  | 0.027      | 0.040 |       |
| b1     | 0.38        | 0.97  | 0.015      | 0.038 | 4     |
| b2     | 1.20        | 1.73  | 0.047      | 0.068 |       |
| b3     | 1.14        | 1.73  | 0.045      | 0.068 | 4     |
| c      | 0.36        | 0.61  | 0.014      | 0.024 |       |
| c1     | 0.36        | 0.56  | 0.014      | 0.022 | 4     |
| D      | 14.85       | 15.25 | 0.585      | 0.600 | 3     |
| D1     | 8.38        | 9.02  | 0.330      | 0.355 |       |
| D2     | 11.68       | 12.88 | 0.460      | 0.507 | 6     |
| E      | 10.11       | 10.51 | 0.398      | 0.414 | 3, 6  |
| E1     | 6.86        | 8.89  | 0.270      | 0.350 | 6     |
| E2     | -           | 0.76  | -          | 0.030 | 7     |
| e      | 2.41        | 2.67  | 0.095      | 0.105 |       |
| e1     | 4.88        | 5.28  | 0.192      | 0.208 |       |
| H1     | 6.09        | 6.48  | 0.240      | 0.255 | 6, 7  |
| L      | 13.52       | 14.02 | 0.532      | 0.552 |       |
| L1     | 3.32        | 3.82  | 0.131      | 0.150 | 2     |
| Ø P    | 3.54        | 3.73  | 0.139      | 0.147 |       |
| Q      | 2.60        | 3.00  | 0.102      | 0.118 |       |
| θ      | 90° to 93°  |       | 90° to 93° |       |       |

#### Notes

- (1) Dimensioning and tolerancing as per ASME Y14.5M-1994
- (2) Lead dimension and finish uncontrolled in L1
- (3) Dimension D, D1 and E do not include mold flash. Mold flash shall not exceed 0.127 mm (0.005") per side. These dimensions are measured at the outermost extremes of the plastic body
- (4) Dimension b1, b3 and c1 apply to base metal only
- (5) Controlling dimensions: inches
- (6) Thermal pad contour optional within dimensions E, H1, D2 and E1
- (7) Dimensions E2 x H1 define a zone where stamping and singulation irregularities are allowed
- (8) Outline conforms to JEDEC TO-220, except A2 (maximum) and D2 (minimum) where dimensions are derived from the actual package outline



## **Disclaimer**

ALL PRODUCT, PRODUCT SPECIFICATIONS AND DATA ARE SUBJECT TO CHANGE WITHOUT NOTICE TO IMPROVE RELIABILITY, FUNCTION OR DESIGN OR OTHERWISE.

Vishay Intertechnology, Inc., its affiliates, agents, and employees, and all persons acting on its or their behalf (collectively, "Vishay"), disclaim any and all liability for any errors, inaccuracies or incompleteness contained in any datasheet or in any other disclosure relating to any product.

Vishay makes no warranty, representation or guarantee regarding the suitability of the products for any particular purpose or the continuing production of any product. To the maximum extent permitted by applicable law, Vishay disclaims (i) any and all liability arising out of the application or use of any product, (ii) any and all liability, including without limitation special, consequential or incidental damages, and (iii) any and all implied warranties, including warranties of fitness for particular purpose, non-infringement and merchantability.

Statements regarding the suitability of products for certain types of applications are based on Vishay's knowledge of typical requirements that are often placed on Vishay products in generic applications. Such statements are not binding statements about the suitability of products for a particular application. It is the customer's responsibility to validate that a particular product with the properties described in the product specification is suitable for use in a particular application. Parameters provided in datasheets and / or specifications may vary in different applications and performance may vary over time. All operating parameters, including typical parameters, must be validated for each customer application by the customer's technical experts. Product specifications do not expand or otherwise modify Vishay's terms and conditions of purchase, including but not limited to the warranty expressed therein.

Except as expressly indicated in writing, Vishay products are not designed for use in medical, life-saving, or life-sustaining applications or for any other application in which the failure of the Vishay product could result in personal injury or death. Customers using or selling Vishay products not expressly indicated for use in such applications do so at their own risk. Please contact authorized Vishay personnel to obtain written terms and conditions regarding products designed for such applications.

No license, express or implied, by estoppel or otherwise, to any intellectual property rights is granted by this document or by any conduct of Vishay. Product names and markings noted herein may be trademarks of their respective owners.

## Looking for pricing, stock, or lifecycle information?

Click below to explore more details on WIN SOURCE:

 [View VS-20CTQ150PBF on WIN SOURCE](#)

 [Vishay Information](#)

## Optimize Your Supply Chain with WIN SOURCE Solutions

-  Global Sourcing Solution
-  Obsolete Management
-  Cost Control Management
-  Shortage Management
-  Alternative Solution
-  Excess Inventory Management