



**THE DATASHEET OF
VN920DSP13TR**





VN920DSP

HIGH SIDE DRIVER

Table 1. General Features

Type	R _{DS(on)}	I _{out}	V _{CC}
VN920DSP	16 mΩ	25 A	36 V

- CMOS COMPATIBLE INPUT
- ON STATE OPEN LOAD DETECTION
- OFF STATE OPEN LOAD DETECTION
- SHORTED LOAD PROTECTION
- UNDERVOLTAGE AND OVERVOLTAGE SHUTDOWN
- PROTECTION AGAINST LOSS OF GROUND
- VERY LOW STAND-BY CURRENT
- REVERSE BATTERY PROTECTION (*)

DESCRIPTION

The VN920DSP is a monolithic device made by using STMicroelectronics VIPower M0-3 Technology, intended for driving any kind of load with one side connected to ground.

Active V_{CC} pin voltage clamp protects the device against low energy spikes (see ISO7637 transient compatibility table).

Figure 1. Package

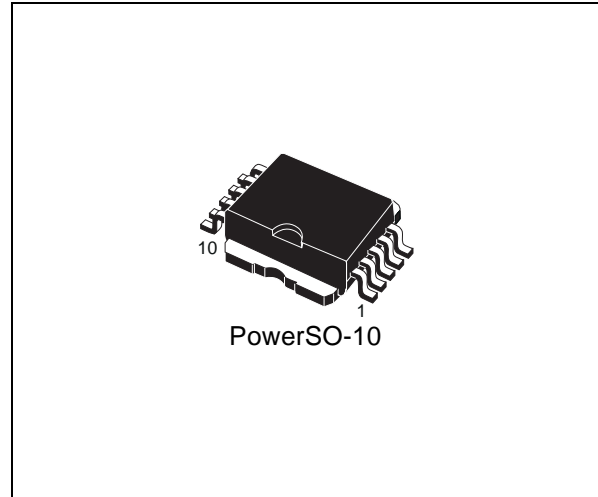

Active current limitation combined with thermal shutdown and automatic restart protect the device against overload.

The device detects open load condition both is on and off state. Output shorted to V_{CC} is detected in the off state. Device automatically turns off in case of ground pin disconnection.

Table 2. Order Codes

Package	Tube	Tape and Reel
PowerSO-10™	VN920DSP	VN920DSP13TR

Note: (*) See application schematic at page 9

Figure 2. Block Diagram

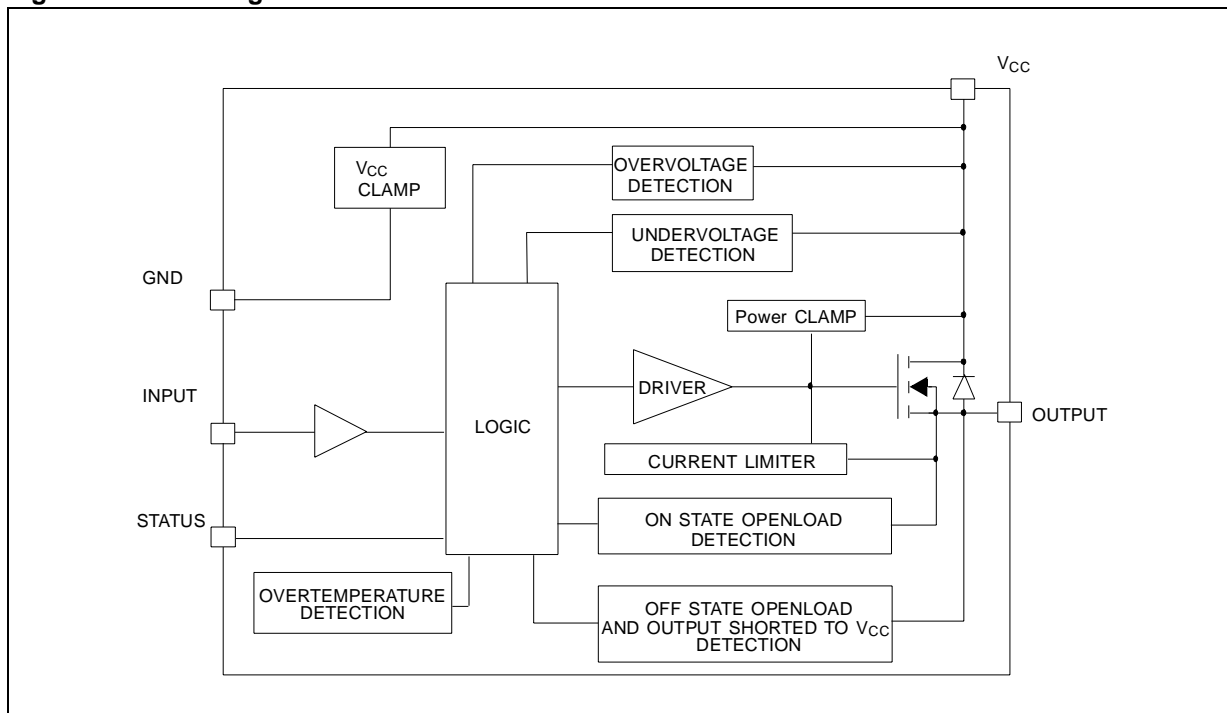

Table 3. Absolute Maximum Ratings

Symbol	Parameter	Value	Unit
V _{CC}	DC Supply Voltage	41	V
-V _{CC}	Reverse DC Supply Voltage	- 0.3	V
-I _{GND}	DC Reverse Ground Pin Current	- 200	mA
I _{OUT}	DC Output Current	Internally Limited	A
-I _{OUT}	Reverse DC Output Current	- 25	A
I _{IN}	DC Input Current	+/- 10	mA
I _{STAT}	DC Status Current	+/- 10	mA
V _{ESD}	Electrostatic Discharge (Human Body Model: R=1.5KΩ; C=100pF)		
	- INPUT	4000	V
	- CURRENT SENSE	4000	V
	- OUTPUT	5000	V
	- V _{CC}	5000	V
E _{MAX}	Maximum Switching Energy (L=0.25mH; R _L =0Ω; V _{bat} =13.5V; T _{jstart} =150°C; I _L =45A)	362	mJ
P _{tot}	Power Dissipation T _C =25°C	96.1	W
T _j	Junction Operating Temperature	Internally Limited	°C
T _c	Case Operating Temperature	- 40 to 150	°C
T _{stg}	Storage Temperature	- 55 to 150	°C

Figure 3. Configuration Diagram (Top View) & Suggested Connections for Unused and N.C. Pins

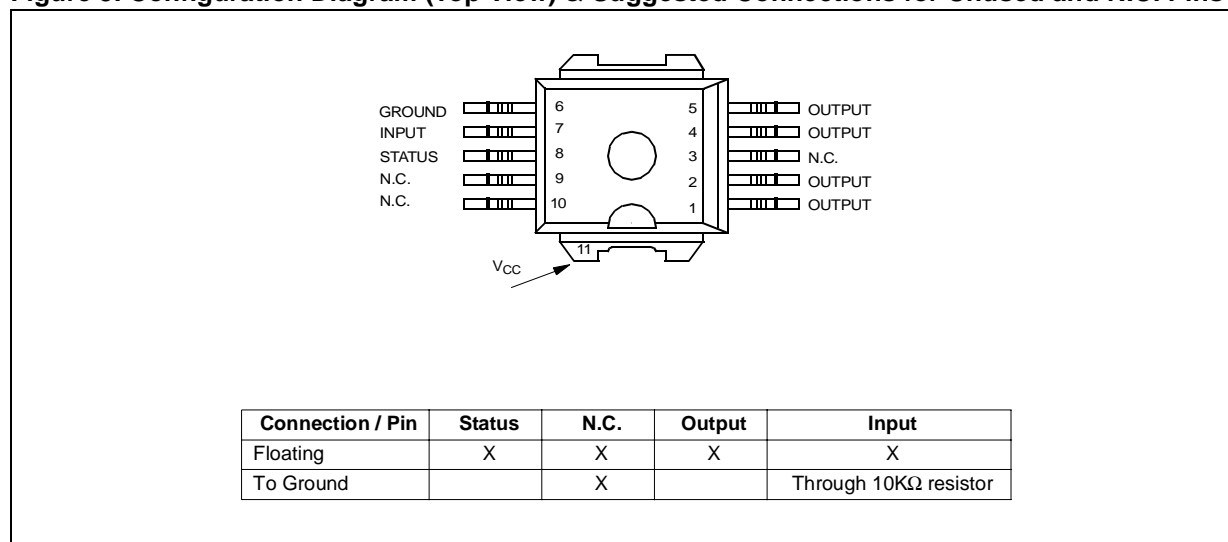

Figure 4. Current and Voltage Conventions

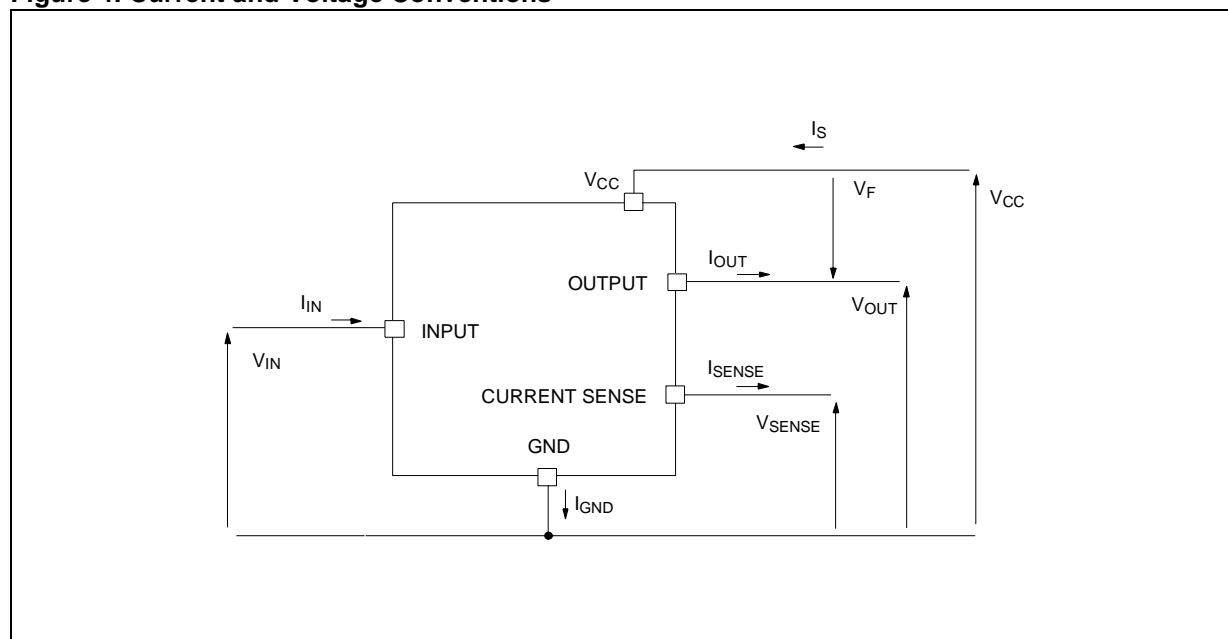

Table 4. Thermal Data

Symbol	Parameter	Value	Unit
$R_{thj-case}$	Thermal Resistance Junction-case	Max 1.3	$^{\circ}C/W$
$R_{thj-amb}$	Thermal Resistance Junction-ambient	Max 51.3 ⁽¹⁾ 37 ⁽²⁾	$^{\circ}C/W$

Note: ⁽¹⁾ When mounted on a standard single-sided FR-4 board with 0.5cm² of Cu (at least 35μm thick).

Note: ⁽²⁾ When mounted on a standard single-sided FR-4 board with 6 cm² of Cu (at least 35μm thick).

ELECTRICAL CHARACTERISTICS

 (8V < V_{CC} < 36V; -40°C < T_j < 150°C unless otherwise specified)

Table 5. Power

Symbol	Parameter	Test Conditions	Min	Typ	Max	Unit
V _{CC}	Operating Supply Voltage		5.5	13	36	V
V _{USD}	Undervoltage Shut-down		3	4	5.5	V
V _{USDhyst}	Undervoltage Shut-down hysteresis			0.5		V
V _{OV}	Overvoltage Shut-down		36			V
R _{ON}	On State Resistance	I _{OUT} =10A; T _j =25°C			16	mΩ
		I _{OUT} =10A			30	mΩ
		I _{OUT} =3A; V _{CC} =6V			50	mΩ
I _S	Supply Current	Off State; V _{CC} =13V; V _{IN} =V _{OUT} =0V		10	25	μA
		Off State; V _{CC} =13V; V _{IN} =V _{OUT} =0V; T _j =25°C		10	20	μA
		On State; V _{CC} =13V; V _{IN} =5V; I _{OUT} =0A			5	mA
I _{L(off1)}	Off State Output Current	V _{IN} =V _{OUT} =0V	0		50	μA
I _{L(off2)}	Off State Output Current	V _{IN} =0V; V _{OUT} =3.5V	-75		0	μA
I _{L(off3)}	Off State Output Current	V _{IN} =V _{OUT} =0V; V _{CC} =13V; T _j =125°C			5	μA
I _{L(off4)}	Off State Output Current	V _{IN} =V _{OUT} =0V; V _{CC} =13V; T _j =25°C			3	μA

Table 6. Switching (V_{CC}=13V)

Symbol	Parameter	Test Conditions	Min	Typ	Max	Unit
t _{d(on)}	Turn-on Delay Time	R _L =1.3Ω		50		μs
t _{d(off)}	Turn-off Delay Time	R _L =1.3Ω		50		μs
dV _{OUT} /dt _(on)	Turn-on Voltage Slope	R _L =1.3Ω		See relative diagram		V/μs
dV _{OUT} /dt _(off)	Turn-off Voltage Slope	R _L =1.3Ω		See relative diagram		V/μs

Table 7. Input Pin

Symbol	Parameter	Test Conditions	Min	Typ	Max	Unit
V _{IL}	Input Low Level				1.25	V
I _{IL}	Low Level Input Current	V _{IN} =1.25V	1			μA
V _{IH}	Input High Level		3.25			V
I _{IH}	High Level Input Current	V _{IN} =3.25V			10	μA
V _{I(hyst)}	Input Hysteresis Voltage		0.5			V
V _{ICL}	Input Clamp Voltage	I _{IN} =1mA	6	6.8	8	V
		I _{IN} =-1mA		-0.7		V

ELECTRICAL CHARACTERISTICS (continued)

Table 8. VCC - Output Diode

Symbol	Parameter	Test Conditions	Min	Typ	Max	Unit
V _F	Forward on Voltage	-I _{OUT} =5A; T _J =150°C			0.6	V

Table 9. Status Pin

Symbol	Parameter	Test Conditions	Min	Typ	Max	Unit
V _{STAT}	Status Low Output Voltage	I _{STAT} =1.6mA			0.5	V
I _{LSTAT}	Status Leakage Current	Normal Operation V _{STAT} =5V			10	μA
C _{STAT}	Status Pin Input Capacitance	Normal Operation V _{STAT} =5V			100	pF
V _{SCL}	Status Clamp Voltage	I _{STAT} =1mA	6	6.8	8	V
		I _{STAT} =-1mA		-0.7		V

Table 10. Protections (see note 1)

Symbol	Parameter	Test Conditions	Min	Typ	Max	Unit
T _{TSD}	Shut-down Temperature		150	175	200	°C
T _R	Reset Temperature		135			°C
T _{hyst}	Thermal Hysteresis		7	15		°C
t _{SDL}	Status delay in overload condition	T _J >T _{TSD}			20	μs
I _{lim}	Current limitation	5.5V<V _{CC} <36V	30	45	75	A
					75	A
V _{demag}	Turn-off Output Clamp Voltage	I _{OUT} =2A; V _{IN} =0V; L=6mH	V _{CC} -41	V _{CC} -48	V _{CC} -55	V

Note: 1. To ensure long term reliability under heavy overload or short circuit conditions, protection and related diagnostic signals must be used together with a proper software strategy. If the device operates under abnormal conditions this software must limit the duration and number of activation cycles.

Table 11. Openload Detection

Symbol	Parameter	Test Conditions	Min	Typ	Max	Unit
I _{OL}	Openload ON State Detection Threshold	V _{IN} =5V	300	500	700	mA
t _{DOL(on)}	Openload ON State Detection Delay	I _{OUT} =0A			200	μs
V _{OL}	Openload OFF State Voltage Detection Threshold	V _{IN} =0V	1.5	2.5	3.5	V
t _{DOL(off)}	Openload Detection Delay at Turn Off				1000	μs

Figure 5.

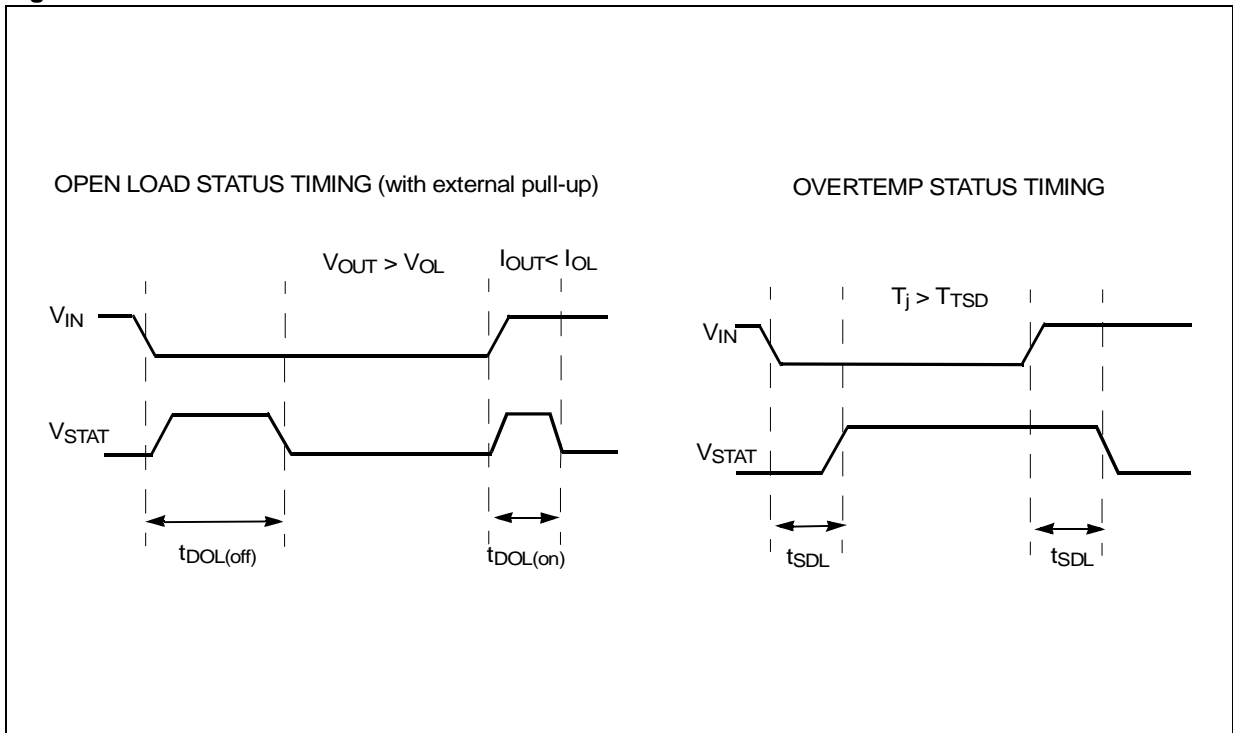

Figure 6. Switching time Waveforms

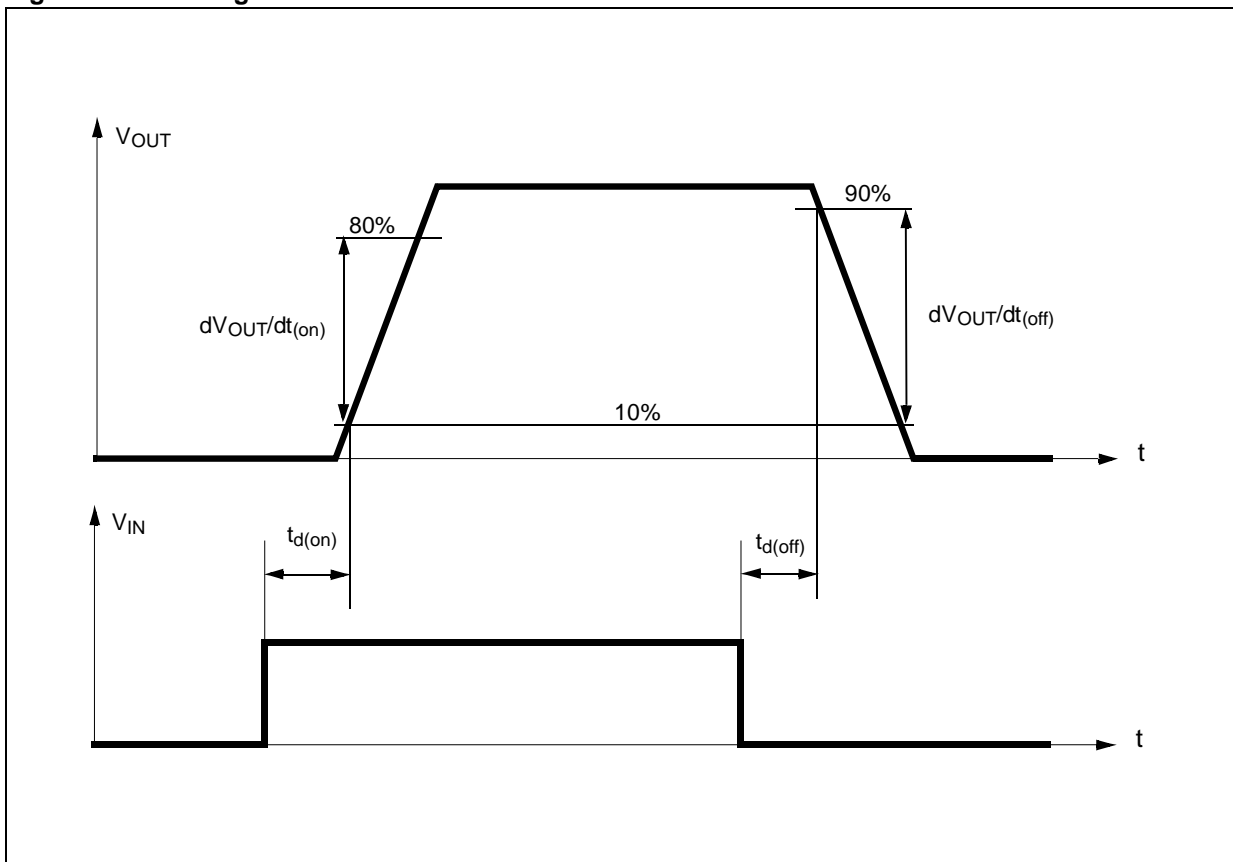

Table 12. Truth Table

CONDITIONS	INPUT	OUTPUT	STATUS
Normal Operation	L	L	H
	H	H	H
Current Limitation	L	L	H
	H	X	($T_j < T_{TSD}$) H
	H	X	($T_j > T_{TSD}$) L
Overtemperature	L	L	H
	H	L	L
Undervoltage	L	L	X
	H	L	X
Overvoltage	L	L	H
	H	L	H
Output Voltage > V_{OL}	L	H	L
	H	H	H
Output Current < I_{OL}	L	L	H
	H	H	L

Table 13. Electrical Transient Requirements On V_{CC} Pin

ISO T/R 7637/1 Test Pulse	TEST LEVELS				Delays and Impedance
	I	II	III	IV	
1	-25 V	-50 V	-75 V	-100 V	2 ms 10 Ω
2	+25 V	+50 V	+75 V	+100 V	0.2 ms 10 Ω
3a	-25 V	-50 V	-100 V	-150 V	0.1 μ s 50 Ω
3b	+25 V	+50 V	+75 V	+100 V	0.1 μ s 50 Ω
4	-4 V	-5 V	-6 V	-7 V	100 ms, 0.01 Ω
5	+26.5 V	+46.5 V	+66.5 V	+86.5 V	400 ms, 2 Ω

ISO T/R 7637/1 Test Pulse	TEST LEVELS RESULTS			
	I	II	III	IV
1	C	C	C	C
2	C	C	C	C
3a	C	C	C	C
3b	C	C	C	C
4	C	C	C	C
5	C	E	E	E

CLASS	CONTENTS
C	All functions of the device are performed as designed after exposure to disturbance.
E	One or more functions of the device is not performed as designed after exposure to disturbance and cannot be returned to proper operation without replacing the device.

Figure 7. Waveforms

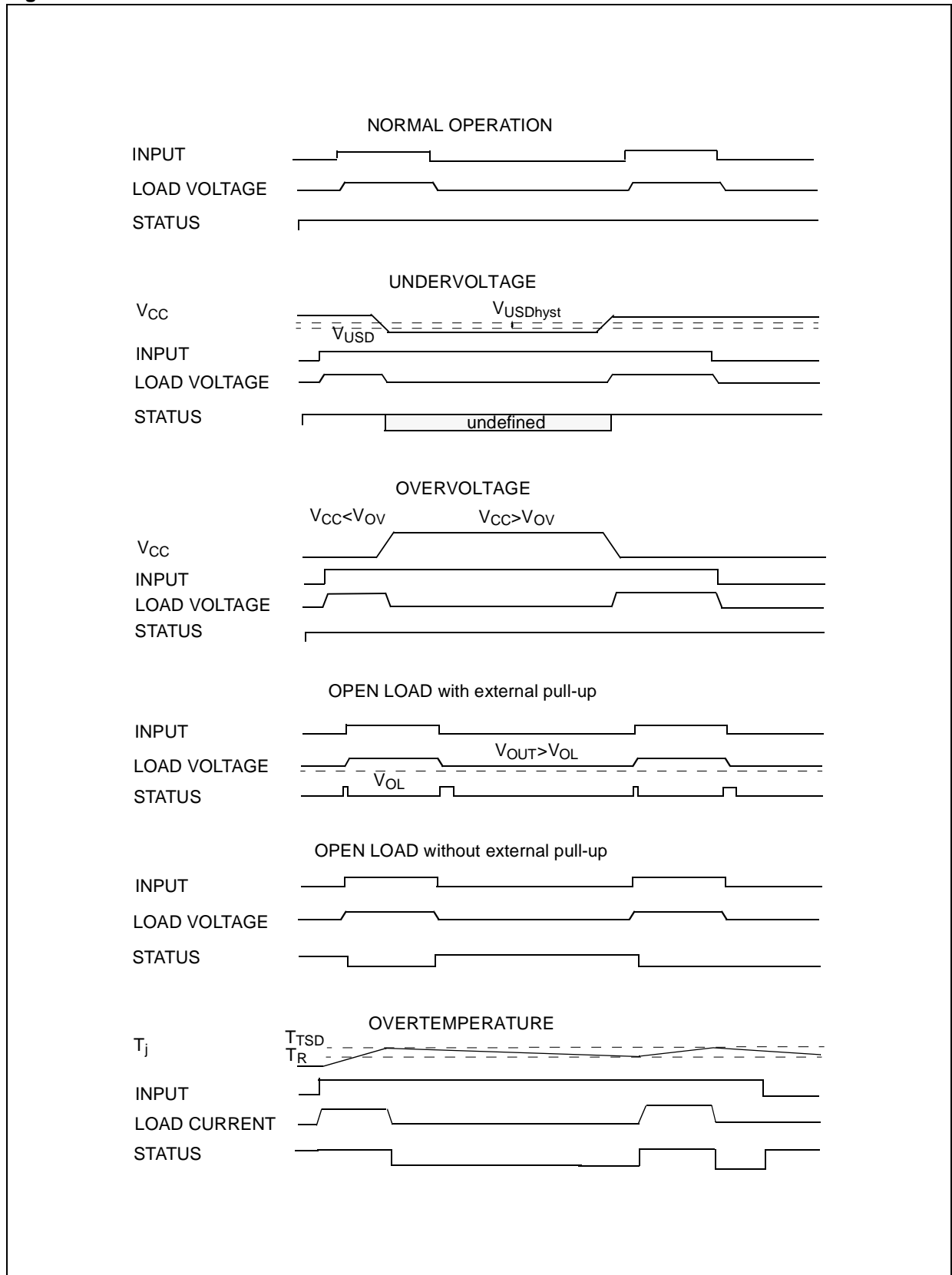
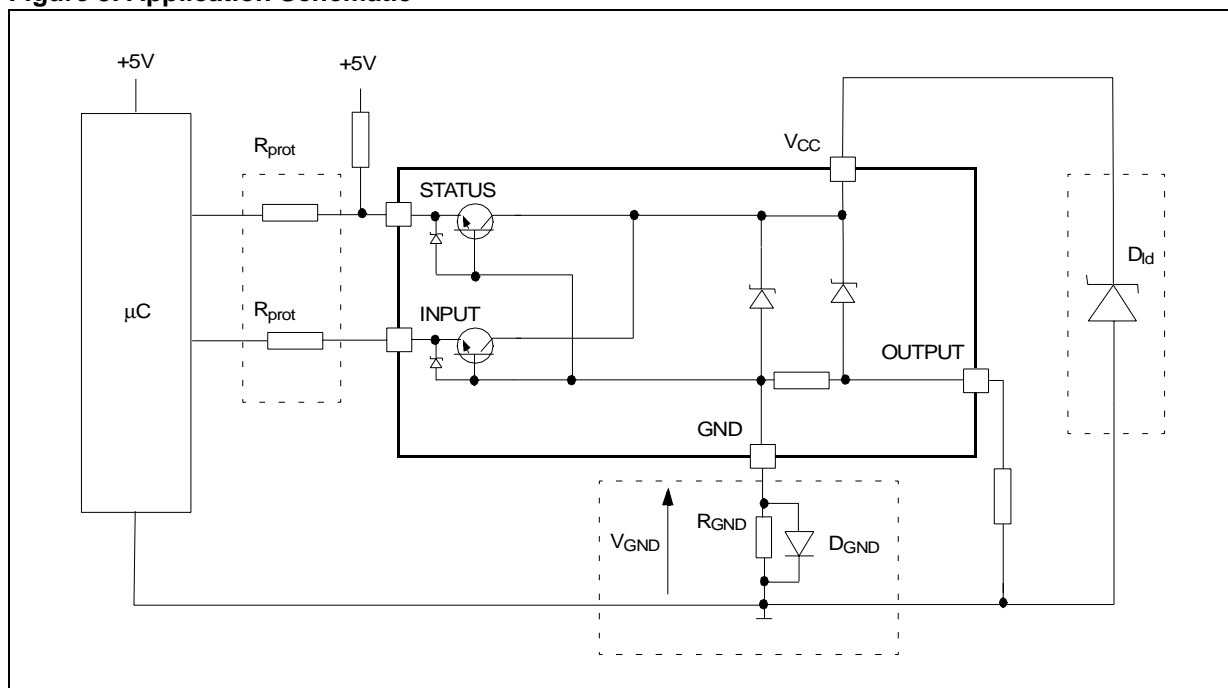

Figure 8. Application Schematic



GND PROTECTION NETWORK AGAINST REVERSE BATTERY

Solution 1: Resistor in the ground line (R_{GND} only). This can be used with any type of load.

The following is an indication on how to dimension the R_{GND} resistor.

- 1) $R_{GND} \leq 600\text{mV} / (I_{S(on)max})$.
- 2) $R_{GND} \geq (-V_{CC}) / (-I_{GND})$

where $-I_{GND}$ is the DC reverse ground pin current and can be found in the absolute maximum rating section of the device's datasheet.

Power Dissipation in R_{GND} (when $V_{CC} < 0$: during reverse battery situations) is:

$$P_D = (-V_{CC})^2 / R_{GND}$$

This resistor can be shared amongst several different HSD. Please note that the value of this resistor should be calculated with formula (1) where $I_{S(on)max}$ becomes the sum of the maximum on-state currents of the different devices.

Please note that if the microprocessor ground is not common with the device ground then the R_{GND} will produce a shift ($I_{S(on)max} * R_{GND}$) in the input thresholds and the status output values. This shift will vary depending on many devices are ON in the case of several high side drivers sharing the same R_{GND} .

If the calculated power dissipation leads to a large resistor or several devices have to share the same resistor then the ST suggests to utilize Solution 2 (see below).

Solution 2: A diode (D_{GND}) in the ground line.

A resistor ($R_{GND} = 1\text{k}\Omega$) should be inserted in parallel to D_{GND} if the device will be driving an inductive load.

This small signal diode can be safely shared amongst several different HSD. Also in this case, the presence of the ground network will produce a shift ($\approx 600\text{mV}$) in the input threshold and the status output values if the microprocessor ground is not common with the device ground. This shift will not vary if more than one HSD shares the same diode/resistor network.

Series resistor in INPUT line is also required to prevent that, during battery voltage transient, the current exceeds the Absolute Maximum Rating.

Safest configuration for unused INPUT pin is to leave it unconnected, while unused SENSE pin has to be connected to Ground pin.

LOAD DUMP PROTECTION

D_{id} is necessary (Voltage Transient Suppressor) if the load dump peak voltage exceeds V_{CC} max DC rating. The same applies if the device will be subject to transients on the V_{CC} line that are greater than the ones shown in the ISO T/R 7637/1 table.

µC I/Os PROTECTION:

If a ground protection network is used and negative transient are present on the V_{CC} line, the control pins will be pulled negative. ST suggests to insert a resistor (R_{prot}) in line to prevent the µC I/Os pins to latch-up.

The value of these resistors is a compromise between the leakage current of µC and the current required by the HSD I/Os (Input levels compatibility) with the latch-up limit of µC I/Os.

$$-V_{CCpeak} / I_{latchup} \leq R_{prot} \leq (V_{OH\mu C} - V_{IH} - V_{GND}) / I_{IHmax}$$

Calculation example:

For $V_{CCpeak} = -100\text{V}$ and $I_{latchup} \geq 20\text{mA}$; $V_{OH\mu C} \geq 4.5\text{V}$
 $5\text{k}\Omega \leq R_{prot} \leq 65\text{k}\Omega$.

Recommended R_{prot} value is $10\text{k}\Omega$.

Figure 9. Off State Output Current

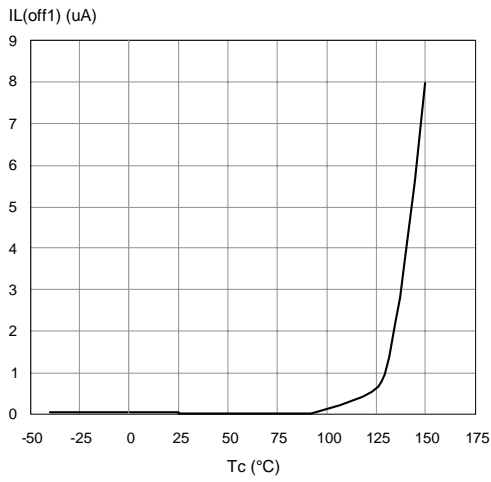

Figure 10. High Level Input Current

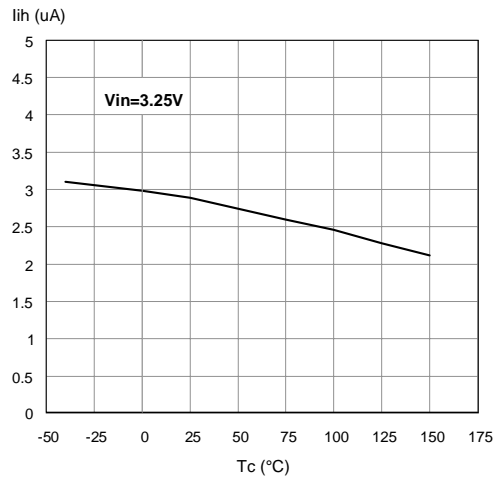

Figure 11. Input Low Level

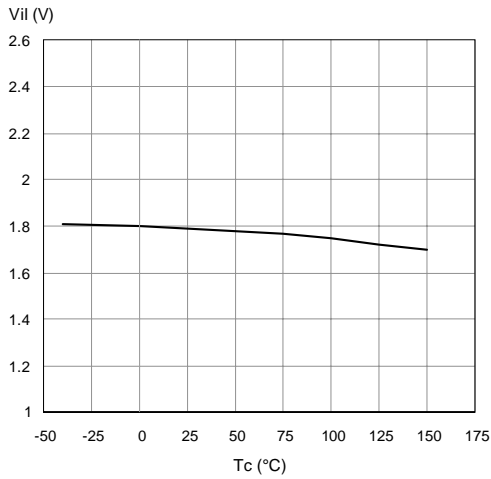

Figure 13. Input High Level

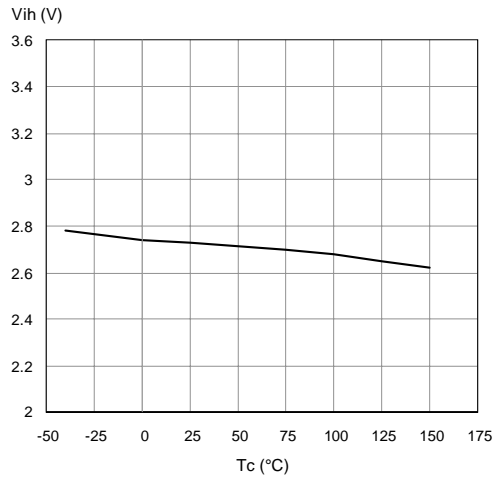

Figure 12. Input Clamp Voltage

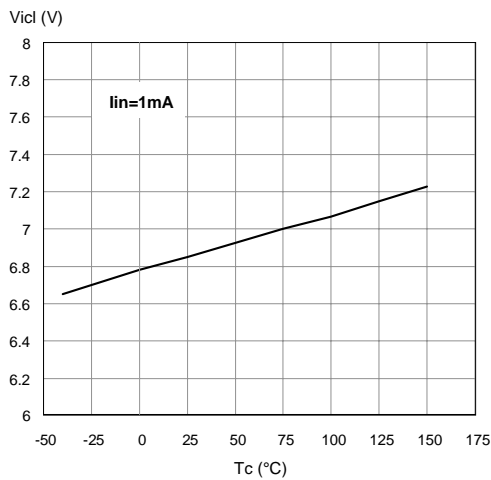

Figure 14. Input Hysteresis Voltage

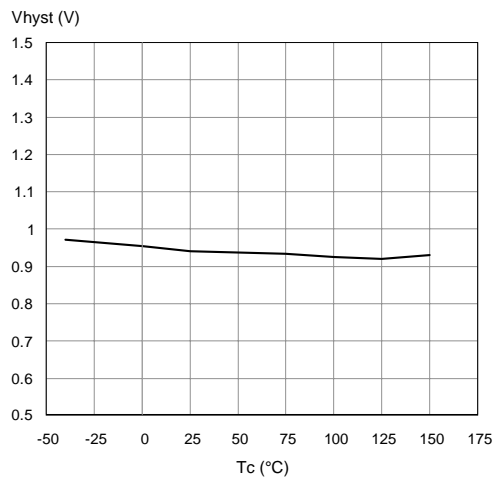

Figure 15. Overvoltage Shutdown

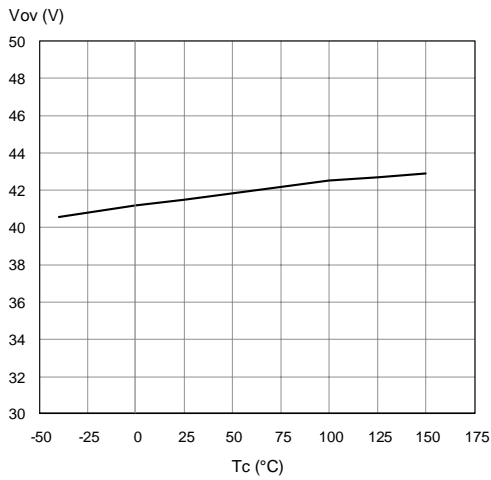

Figure 18. I_{LIM} Vs T_{case}

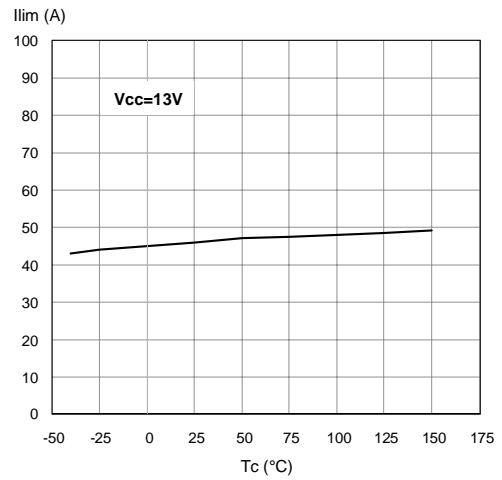

Figure 16. Turn-on Voltage Slope

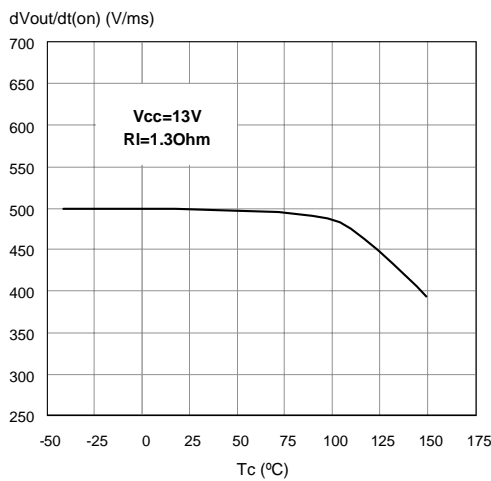

Figure 19. Turn-off Voltage Slope

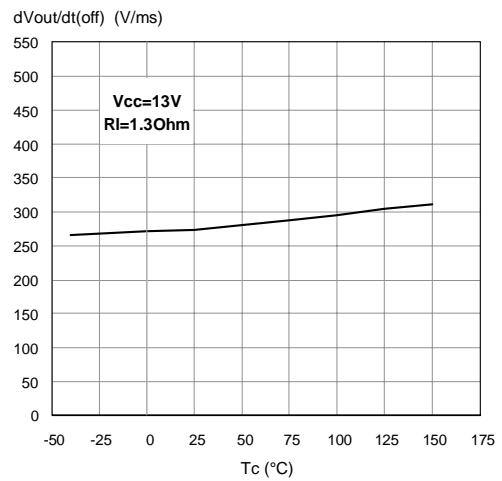

Figure 17. On State Resistance Vs T_{case}

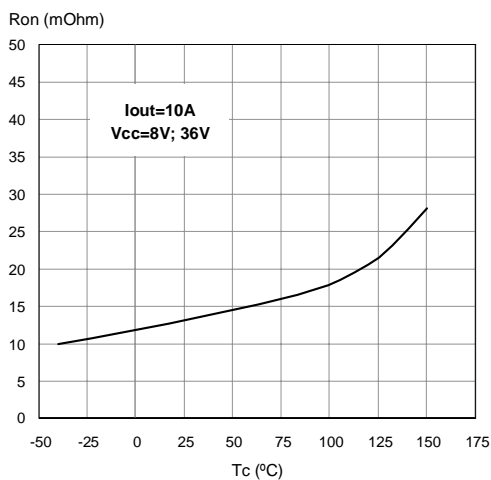

Figure 20. On State Resistance Vs V_{CC}

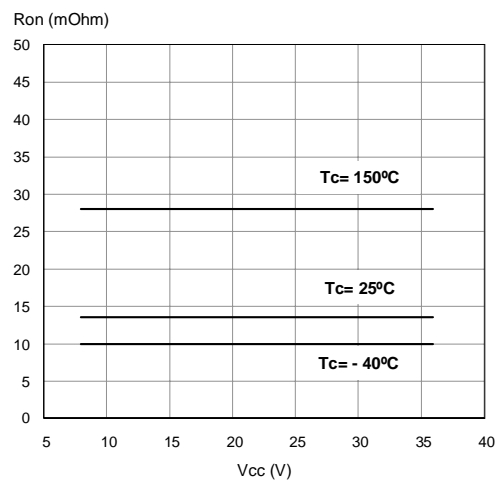

Figure 21. Status Leakage Current

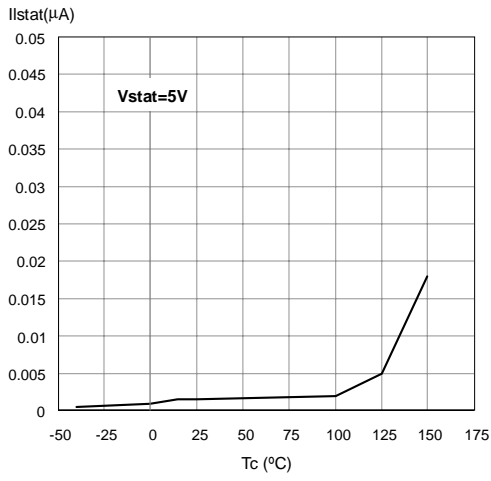

Figure 23. Status Low Output Voltage

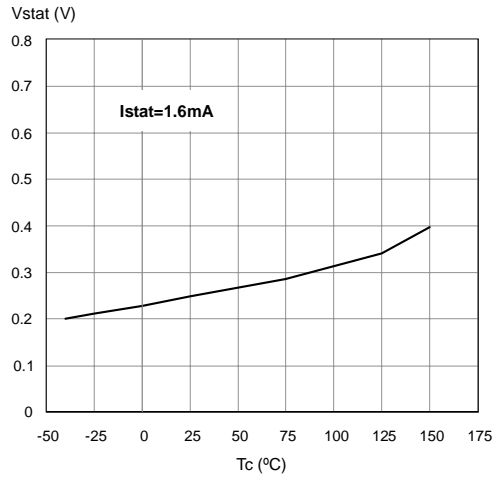

Figure 22. Status Clamp Voltage

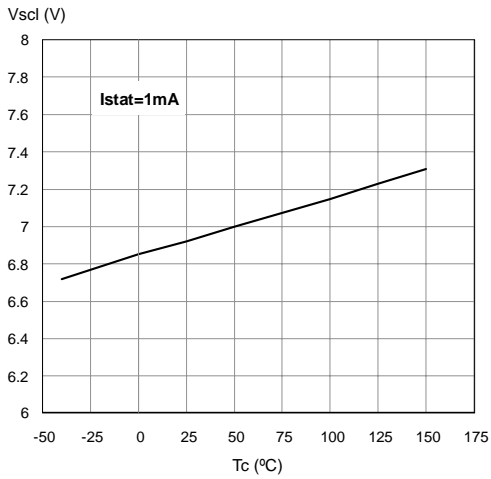
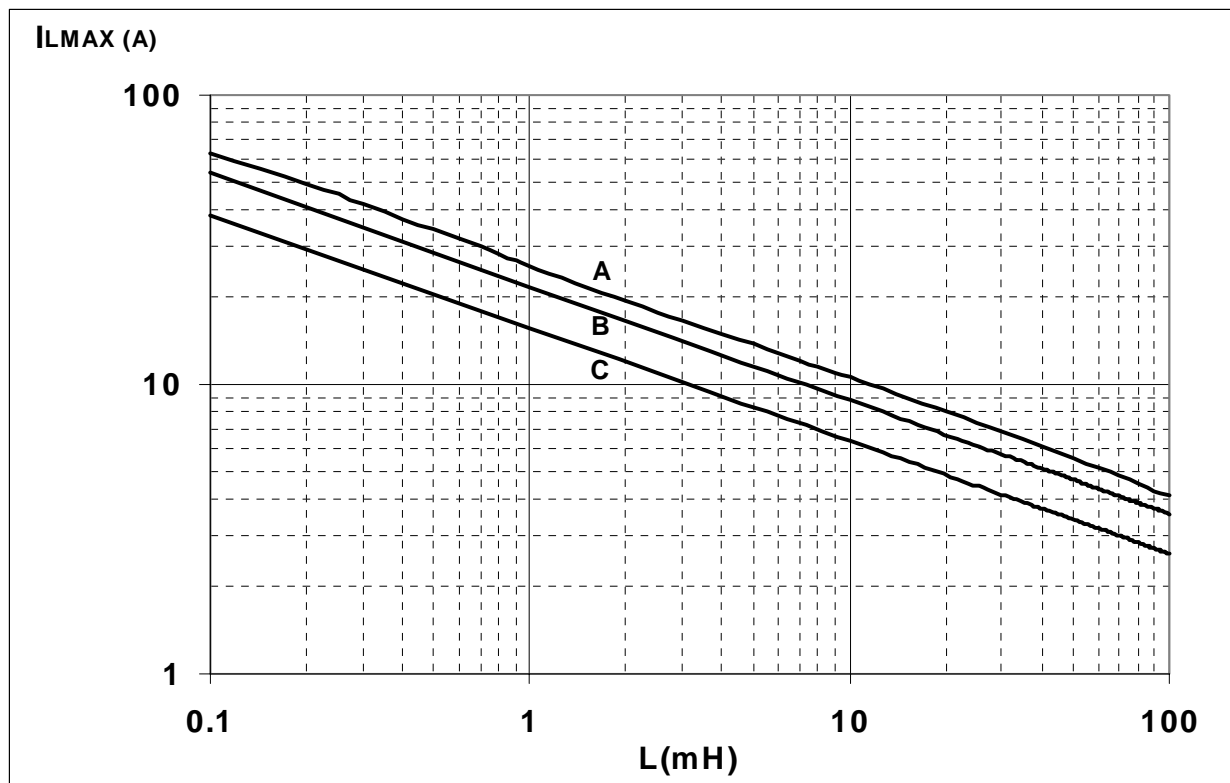

Figure 24. Maximum turn off current versus load inductance



- A = Single Pulse at $T_{Jstart}=150^{\circ}C$
- B= Repetitive pulse at $T_{Jstart}=100^{\circ}C$
- C= Repetitive Pulse at $T_{Jstart}=125^{\circ}C$

Conditions:

$V_{CC}=13.5V$

Values are generated with $R_L=0\Omega$

In case of repetitive pulses, T_{Jstart} (at beginning of each demagnetization) of every pulse must not exceed the temperature specified above for curves B and C.

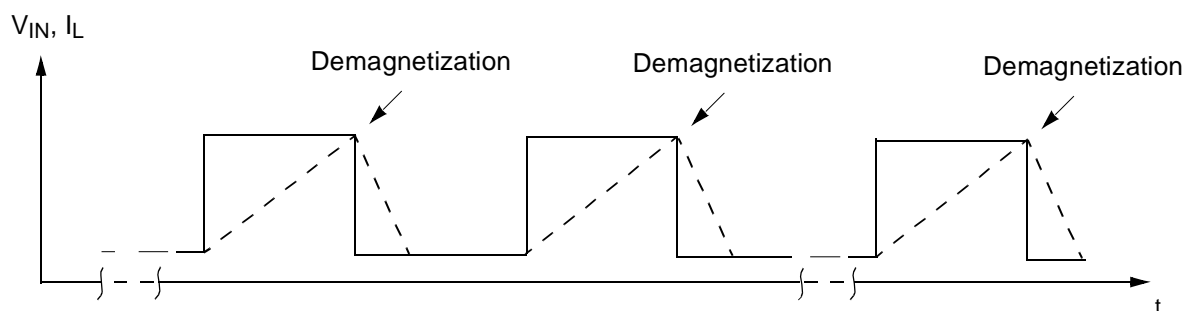

PowerSO-10™ Thermal Data

Figure 25. PowerSO-10™ PC Board

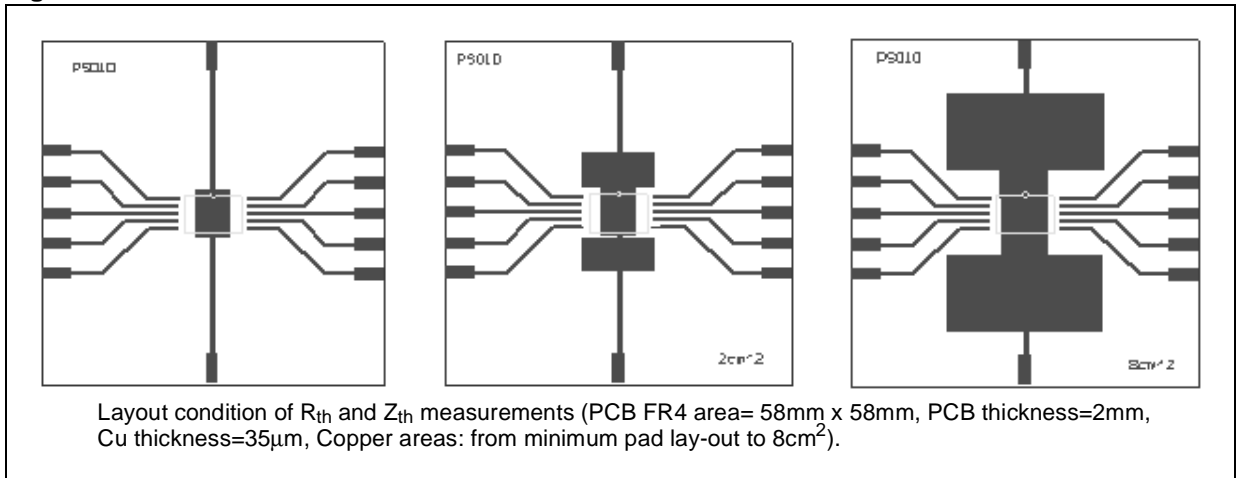

Figure 26. $R_{thj-amb}$ Vs PCB copper area in open box free air condition

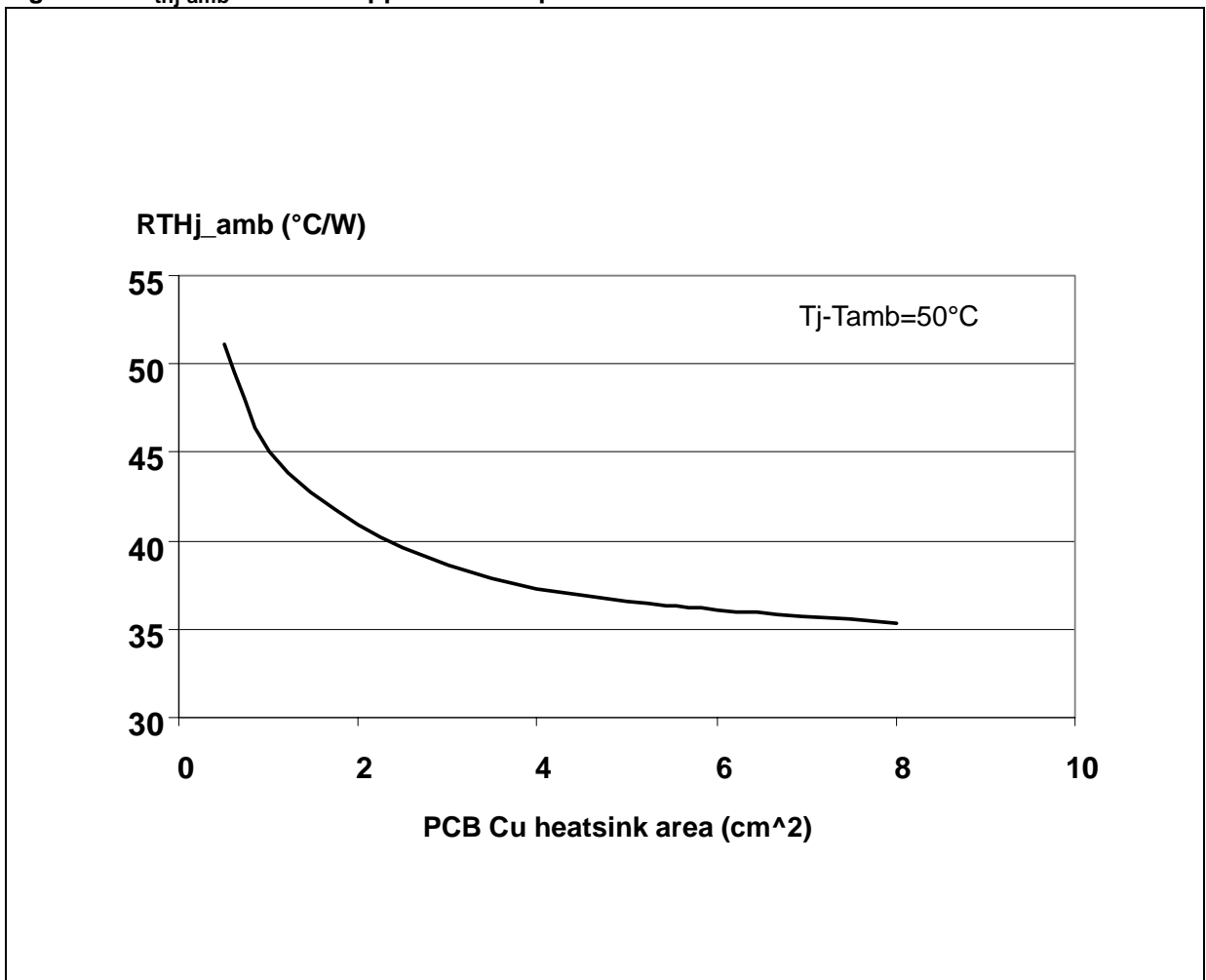

Figure 27. PowerSO-10 Thermal Impedance Junction Ambient Single Pulse

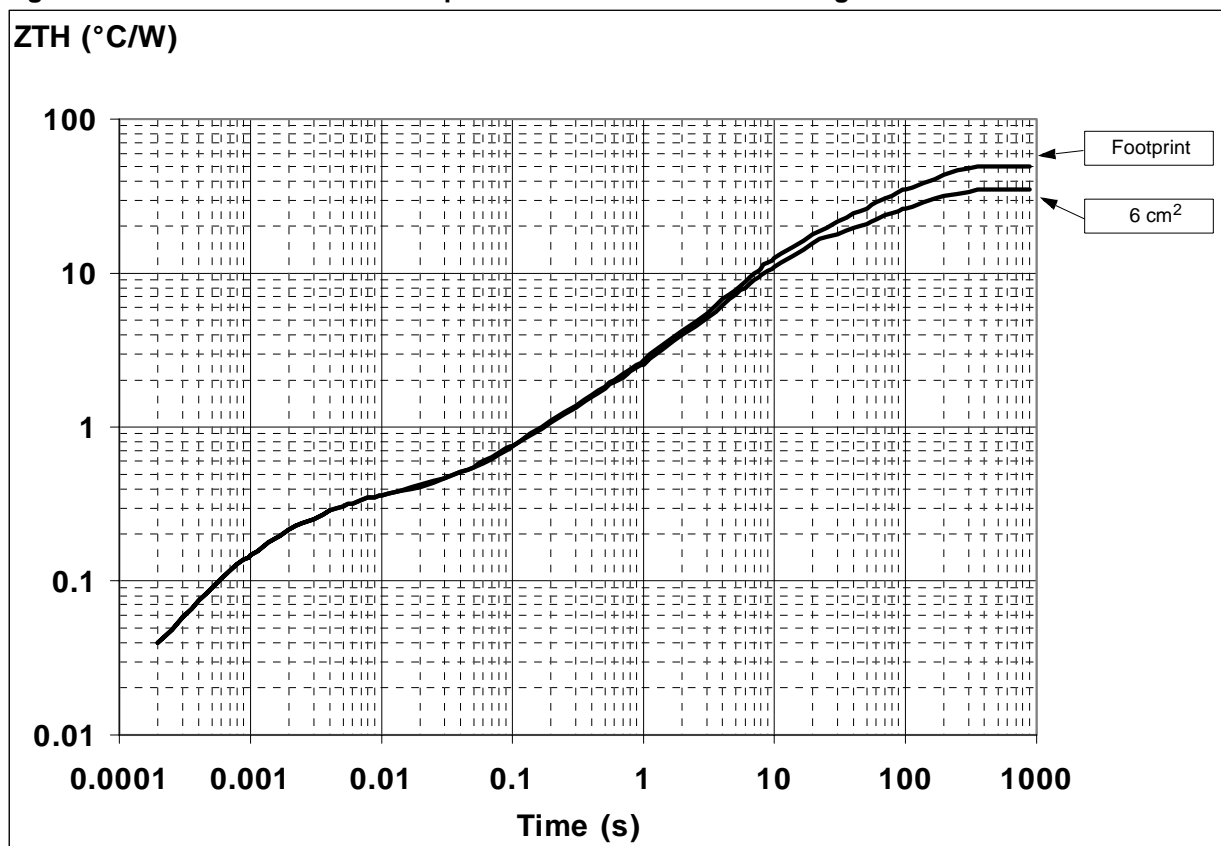
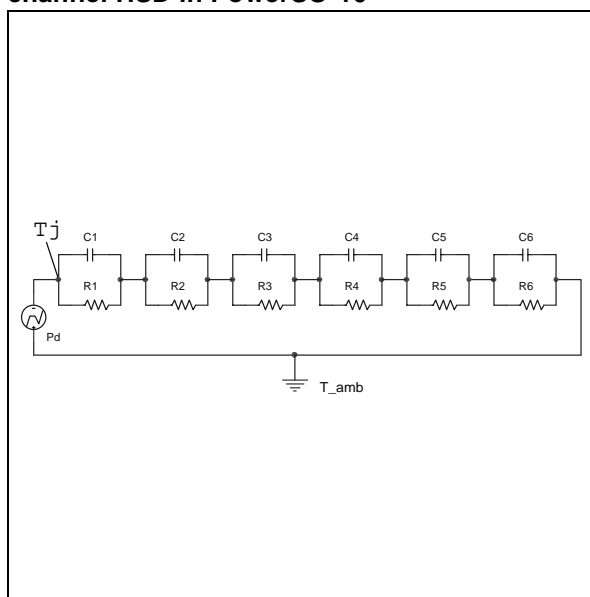

Figure 28. Thermal fitting model of a double channel HSD in PowerSO-10



Pulse calculation formula

$$Z_{TH\delta} = R_{TH} \cdot \delta + Z_{THtp}(1 - \delta)$$

where $\delta = t_p/T$

Table 14. Thermal Parameter

Area/island (cm ²)	Footprint	6
R1 (°C/W)	0.02	
R2 (°C/W)	0.1	
R3 (°C/W)	0.2	
R4 (°C/W)	0.8	
R5 (°C/W)	12	
R6 (°C/W)	37	22
C1 (W.s/°C)	0.0015	
C2 (W.s/°C)	7.00E-03	
C3 (W.s/°C)	0.015	
C4 (W.s/°C)	0.3	
C5 (W.s/°C)	0.75	
C6 (W.s/°C)	3	5

PACKAGE MECHANICAL

Table 15. PowerSO-10™ Mechanical Data

Symbol	millimeters		
	Min	Typ	Max
A	3.35		3.65
A (*)	3.4		3.6
A1	0.00		0.10
B	0.40		0.60
B (*)	0.37		0.53
C	0.35		0.55
C (*)	0.23		0.32
D	9.40		9.60
D1	7.40		7.60
E	9.30		9.50
E2	7.20		7.60
E2 (*)	7.30		7.50
E4	5.90		6.10
E4 (*)	5.90		6.30
e		1.27	
F	1.25		1.35
F (*)	1.20		1.40
H	13.80		14.40
H (*)	13.85		14.35
h		0.50	
L	1.20		1.80
L (*)	0.80		1.10
a	0°		8°
α (*)	2°		8°

Note: (*) Muar only POA P013P

Figure 29. PowerSO-10™ Package Dimensions

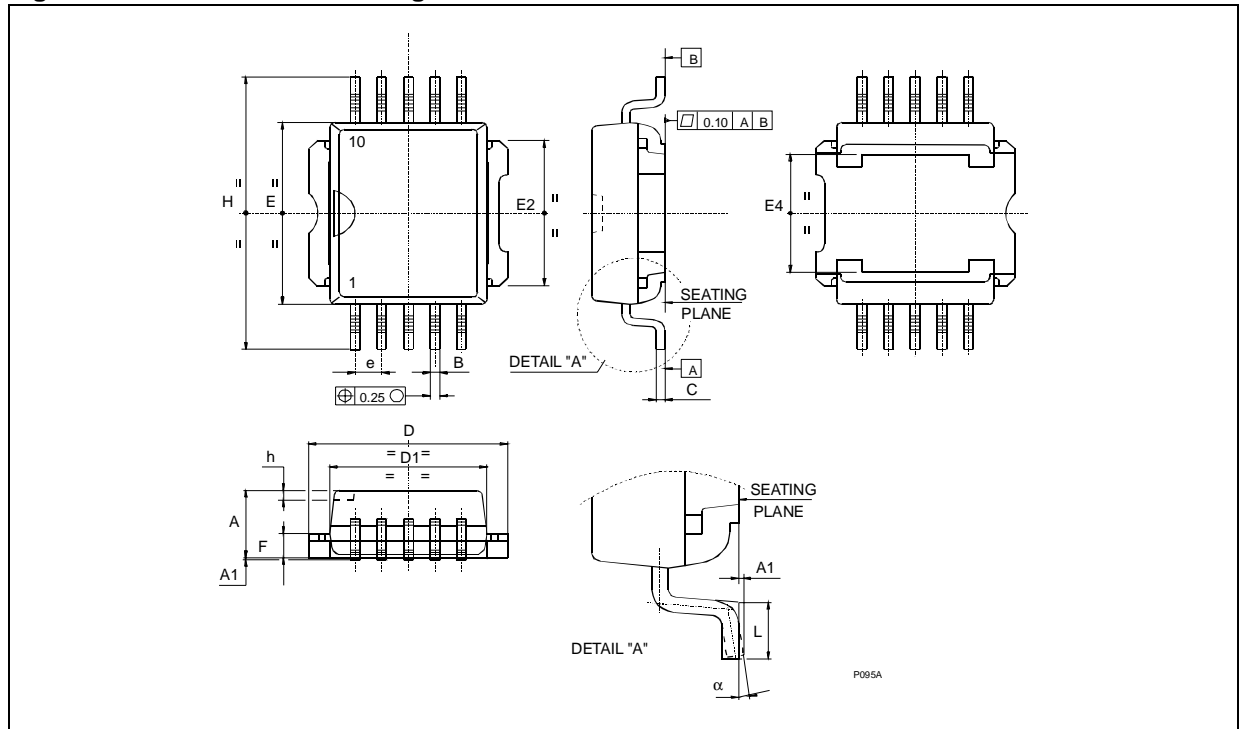

Figure 30. PowerSO-10™ Suggested Pad Layout And Tube Shipment (no suffix)

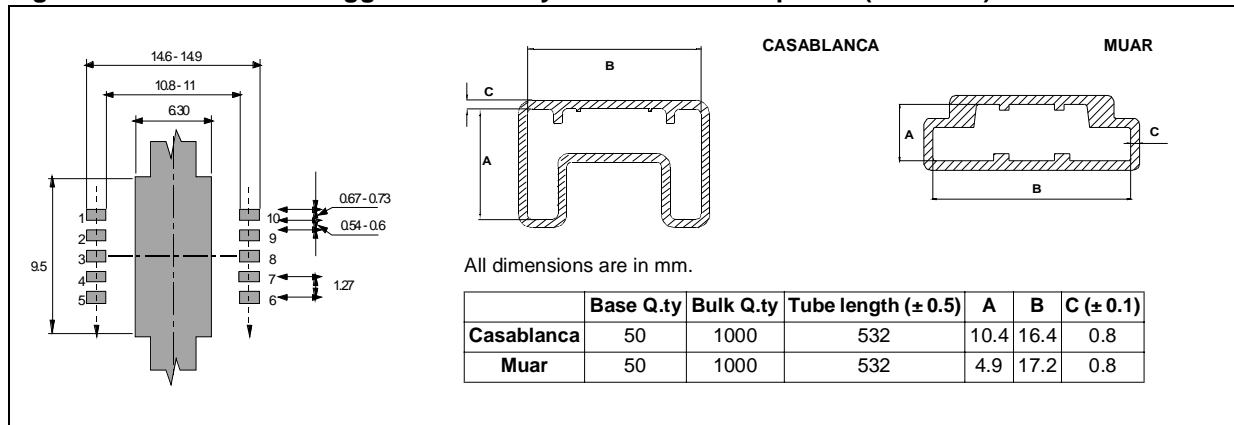
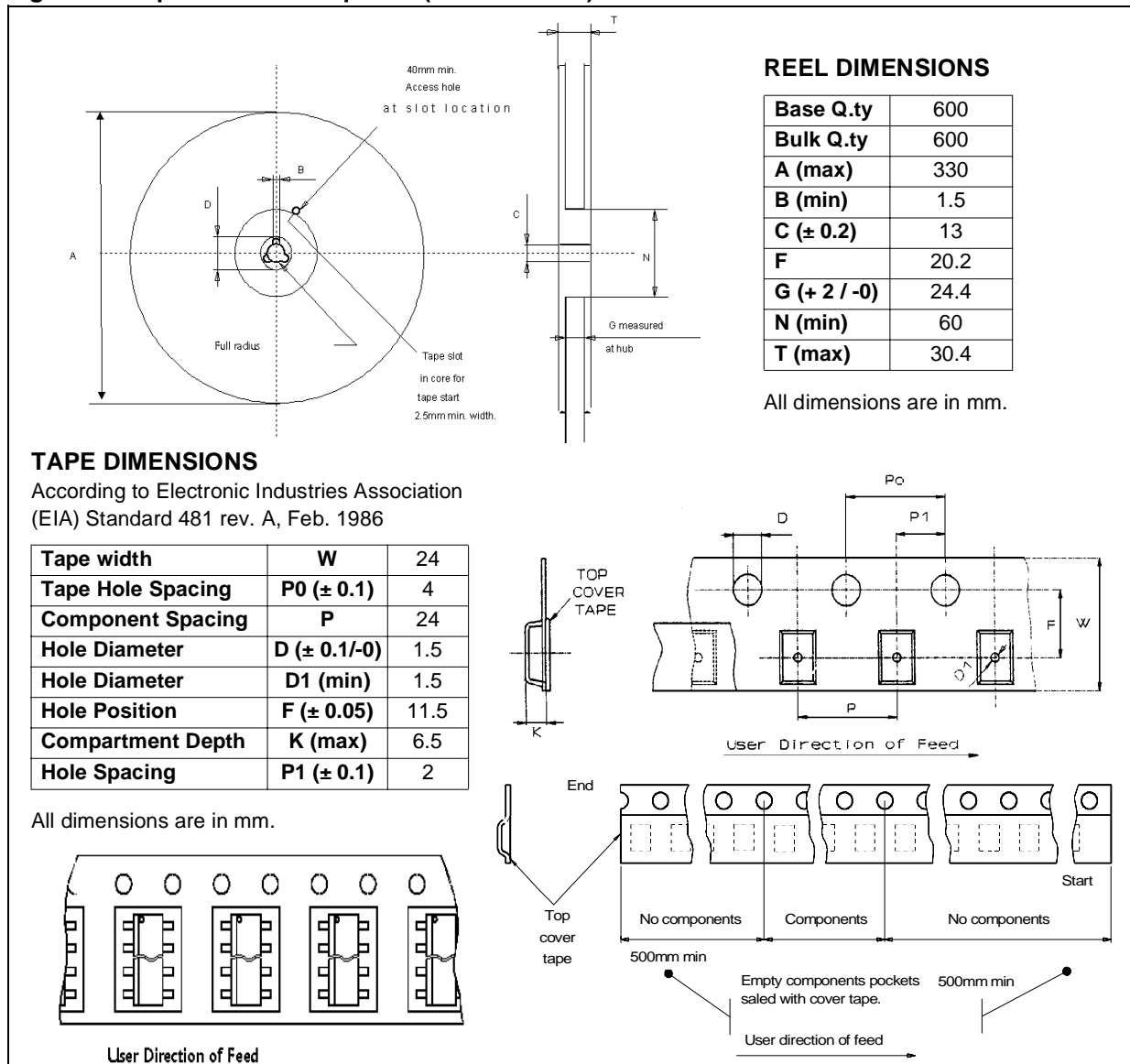

Figure 31. Tape And Reel Shipment (suffix “13TR”)



REVISION HISTORY

Date	Revision	Description of Changes
Sep. 2004	1	- First Issue.
Oct. 2004	2	- Minor text change.
24-Sep-2013	3	- Updated Disclaimer

Please Read Carefully:

Information in this document is provided solely in connection with ST products. STMicroelectronics NV and its subsidiaries ("ST") reserve the right to make changes, corrections, modifications or improvements, to this document, and the products and services described herein at any time, without notice.

All ST products are sold pursuant to ST's terms and conditions of sale.

Purchasers are solely responsible for the choice, selection and use of the ST products and services described herein, and ST assumes no liability whatsoever relating to the choice, selection or use of the ST products and services described herein.

No license, express or implied, by estoppel or otherwise, to any intellectual property rights is granted under this document. If any part of this document refers to any third party products or services it shall not be deemed a license grant by ST for the use of such third party products or services, or any intellectual property contained therein or considered as a warranty covering the use in any manner whatsoever of such third party products or services or any intellectual property contained therein.

UNLESS OTHERWISE SET FORTH IN ST'S TERMS AND CONDITIONS OF SALE ST DISCLAIMS ANY EXPRESS OR IMPLIED WARRANTY WITH RESPECT TO THE USE AND/OR SALE OF ST PRODUCTS INCLUDING WITHOUT LIMITATION IMPLIED WARRANTIES OF MERCHANTABILITY, FITNESS FOR A PARTICULAR PURPOSE (AND THEIR EQUIVALENTS UNDER THE LAWS OF ANY JURISDICTION), OR INFRINGEMENT OF ANY PATENT, COPYRIGHT OR OTHER INTELLECTUAL PROPERTY RIGHT.

ST PRODUCTS ARE NOT DESIGNED OR AUTHORIZED FOR USE IN: (A) SAFETY CRITICAL APPLICATIONS SUCH AS LIFE SUPPORTING, ACTIVE IMPLANTED DEVICES OR SYSTEMS WITH PRODUCT FUNCTIONAL SAFETY REQUIREMENTS; (B) AERONAUTIC APPLICATIONS; (C) AUTOMOTIVE APPLICATIONS OR ENVIRONMENTS, AND/OR (D) AEROSPACE APPLICATIONS OR ENVIRONMENTS. WHERE ST PRODUCTS ARE NOT DESIGNED FOR SUCH USE, THE PURCHASER SHALL USE PRODUCTS AT PURCHASER'S SOLE RISK, EVEN IF ST HAS BEEN INFORMED IN WRITING OF SUCH USAGE, UNLESS A PRODUCT IS EXPRESSLY DESIGNATED BY ST AS BEING INTENDED FOR "AUTOMOTIVE, AUTOMOTIVE SAFETY OR MEDICAL" INDUSTRY DOMAINS ACCORDING TO ST PRODUCT DESIGN SPECIFICATIONS. PRODUCTS FORMALLY ESCC, QML OR JAN QUALIFIED ARE DEEMED SUITABLE FOR USE IN AEROSPACE BY THE CORRESPONDING GOVERNMENTAL AGENCY.

Resale of ST products with provisions different from the statements and/or technical features set forth in this document shall immediately void any warranty granted by ST for the ST product or service described herein and shall not create or extend in any manner whatsoever, any liability of ST.

ST and the ST logo are trademarks or registered trademarks of ST in various countries.

Information in this document supersedes and replaces all information previously supplied.

The ST logo is a registered trademark of STMicroelectronics. All other names are the property of their respective owners.

© 2013 STMicroelectronics - All rights reserved

STMicroelectronics group of companies



Australia - Belgium - Brazil - Canada - China - Czech Republic - Finland - France - Germany - Hong Kong - India - Israel - Italy - Japan - Malaysia - Malta - Morocco - Philippines - Singapore - Spain - Sweden - Switzerland - United Kingdom - United States of America

www.st.com



Looking for pricing, stock, or lifecycle information?

Click below to explore more details on WIN SOURCE:

-  [View VN920DSP13TR](#) on WIN SOURCE
-  [STMicroelectronics](#) Information

Optimize Your Supply Chain with WIN SOURCE Solutions

-  Global Sourcing Solution
-  Obsolete Management
-  Cost Control Management
-  Shortage Management
-  Alternative Solution
-  Excess Inventory Management