



**THE DATASHEET OF
UJA1161TK,118**



UJA1161

Self-supplied high-speed CAN transceiver with Standby mode

Rev. 2 — 17 April 2014

Product data sheet

1. General description

The UJA1161 is a 'self-supplied' high-speed CAN transceiver integrating an ISO 11898-2/5 compliant HS-CAN transceiver and an internal 5 V CAN supply. The only supply input is a battery connection. The UJA1161 can be operated in a very low-current Standby mode with bus wake-up capability.

The UJA1161 implements the standard CAN physical layer as defined in the current ISO11898 standard (-2 and -5). Pending the release of the updated version of ISO11898 including CAN FD, additional timing parameters defining loop delay symmetry are included. This implementation enables reliable communication in the CAN FD fast phase at data rates up to 2 Mbit/s.

2. Features and benefits

2.1 General

- Self-supplied high-speed CAN transceiver
- Loop delay symmetry timing enables reliable communication at data rates up to 2 Mbit/s in the CAN FD fast phase
- ISO 11898-2 and ISO 11898-5 compliant
- Autonomous bus biasing according to ISO 11898-6
- Fully integrated 5 V supply (V_{BUF}) for the CAN transmitter/receiver
- VIO input allows for direct interfacing with 3.3 V to 5 V microcontrollers
- Bus connections are truly floating when power pin BAT is off

2.2 Designed for automotive applications

- ± 8 kV ElectroStatic Discharge (ESD) protection, according to the Human Body Model (HBM) on the CAN bus pins
- ± 6 kV ESD protection, according to IEC 61000-4-2 on the CAN bus pins and on pin BAT
- CAN bus pins short-circuit proof to ± 58 V
- Battery and CAN bus pins are protected against automotive transients according to with ISO 7637-3
- Very low quiescent current in Standby mode
- Leadless HVSON14 package (3 mm \times 4.5 mm) with improved Automated Optical Inspection (AOI) capability
- Dark green product (halogen free and Restriction of Hazardous Substances (RoHS) compliant)



2.3 Integrated supply voltage for the CAN transceiver (V_{BUF})

- 5 V nominal output; ± 2 % accuracy
- Undervoltage detection at 90 % of nominal value
- Excellent response with a 4.7 μ F ceramic output load capacitor

2.4 Power Management

- Standby mode featuring very low supply current
- Remote wake-up capability via standard CAN wake-up pattern

2.5 System control and diagnostic features

- Mode control via STBN pin
- Overtemperature shutdown
- Transmit data (TXD) dominant time-out function

3. Ordering information

Table 1. Ordering information

Type number	Package		
	Name	Description	Version
UJA1161TK	HVSON14	plastic thermal enhanced very thin small outline package; no leads; 14 terminals; body 3 × 4.5 × 0.85 mm	SOT1086-2

4. Block diagram

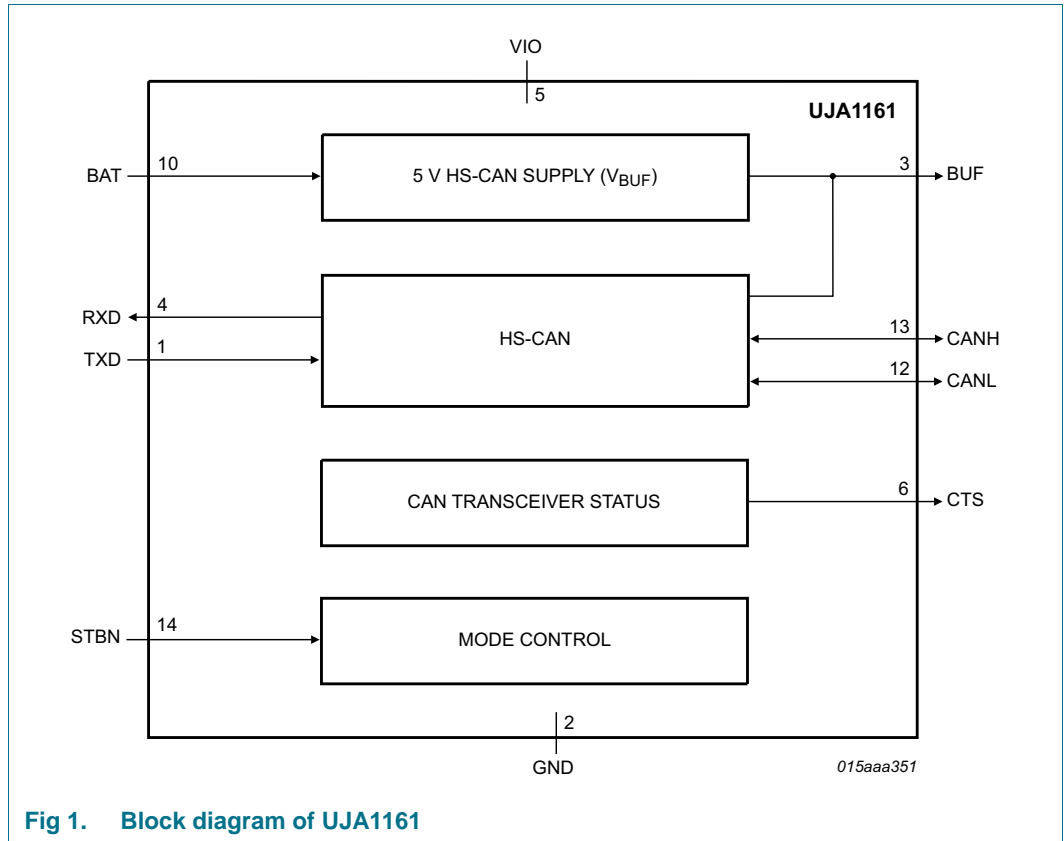
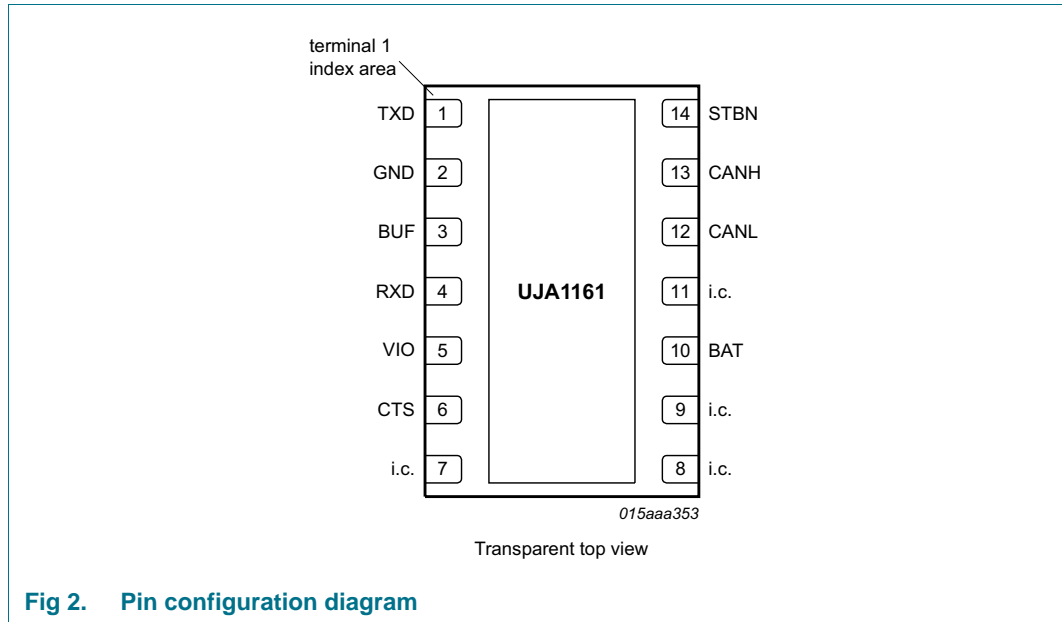

Fig 1. Block diagram of UJA1161

5. Pinning information

5.1 Pinning



5.2 Pin description

Table 2. Pin description

Symbol	Pin	Description
TXD	1	transmit data input
GND	2 ^[1]	ground
BUF	3	5 V transceiver supply voltage
RXD	4	receive data output; reads out data from the bus lines
VIO	5	supply voltage for I/O level adaptor
CTS	6	CAN transceiver status output
i.c.	7	internally connected; should be left floating or connected to GND
i.c.	8	internally connected; should be left floating or connected to GND
i.c.	9	internally connected; should be left floating or connected to GND
BAT	10	battery supply voltage
i.c.	11	internally connected; should be left floating or connected to GND
CANL	12	LOW-level CAN bus line
CANH	13	HIGH-level CAN bus line
STBN	14	standby control input (active LOW)

[1] The exposed die pad at the bottom of the package allows for better heat dissipation and grounding from the transceiver via the printed circuit board. For enhanced thermal and electrical performance, it is recommended to solder the exposed die pad to GND.

6. Functional description

The UJA1161 is a self-supplied high-speed CAN transceiver incorporating a 5 V CAN supply. A variety of fail-safe and diagnostic features offer enhanced system reliability.

6.1 System controller

The system controller is a state machine that manages register configuration and controls the internal functions of the UJA1161. UJA1161 operating modes and state transitions are illustrated in [Figure 3](#). These modes are discussed in more detail in the following sections.

6.1.1 Operating modes

The UJA1161 supports four operating modes: Normal, Standby, Overtemp and Off.

6.1.1.1 Normal mode

Normal mode is the active operating mode. In this mode, the UJA1161 is fully operational. Normal mode can be selected from Standby mode by setting pin STBN HIGH, provided $V_{IO} > V_{uvd(VIO)}$. The UJA1161 exits Normal mode:

- if the microcontroller selects Standby mode by setting pin STBN LOW
- if the UJA1161 detects an undervoltage on VIO, causing the UJA1161 to switch to Standby mode
- if the chip temperature rises above $T_{th(Act)otp}$, causing the UJA1161 to switch to Overtemp mode
- if the battery supply voltage drops below $V_{th(det)poff}$, causing the UJA1161 to switch to Off mode

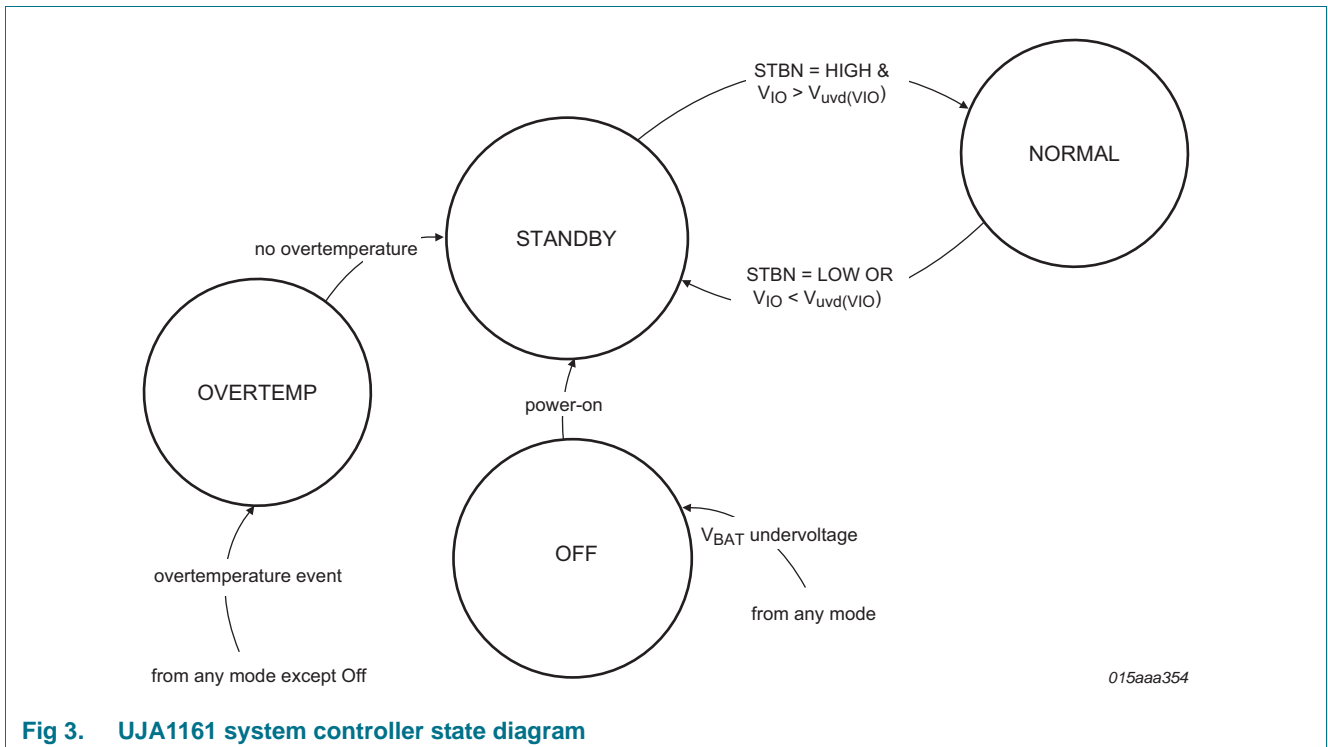

Fig 3. UJA1161 system controller state diagram

6.1.1.2 Standby mode

Standby mode is the UJA1161’s power saving mode, offering reduced current consumption. The transceiver is unable to transmit or receive data in Standby mode.

The receiver monitors bus activity for a wake-up request in Standby mode. The bus pins are biased at GND level (via $R_{i(cm)}$) when the bus is inactive for $t > t_{to(silence)}$ and at approximately 2.5 V when there is activity on the bus (autonomous biasing). CAN wake-up occurs via a standard wake-up pattern (see [Section 6.3.2](#)). Pin RXD is forced LOW when a bus wake-up event is detected.

The UJA1161 switches to Standby mode:

- from Normal mode if pin STBN goes LOW
- from Normal mode if an undervoltage is detected on VIO

6.1.1.3 Off mode

The UJA1161 switches to Off mode from any mode when $V_{BAT} < V_{th(det)poff}$. Only power-on detection is enabled; all other modules are inactive. The UJA1161 starts to boot up when the battery voltage rises above the power-on detection threshold $V_{th(det)pon}$ (triggering an initialization process) and switches to Standby mode after $t_{startup}$. Pin RXD is driven LOW when the UJA1161 switches from Off mode to Standby mode, to indicate a power-on event has occurred.

In Off mode, the CAN pins disengage from the bus (zero load; high-ohmic).

6.1.1.4 Overtemp mode

Overtemp mode is provided to prevent the UJA1161 being damaged by excessive temperatures. The UJA1161 switches immediately to Overtemp mode from Normal or Standby mode when the global chip temperature rises above the overtemperature protection activation threshold, $T_{th(act)otp}$.

In Overtemp mode, the CAN transmitter and receiver are disabled and the CAN pins are in a high-ohmic state. No wake-up event will be detected, but a pending wake-up will still be signalled by a LOW level on pin RXD, which will persist after the overtemperature event has been cleared. V_{BUF} is off in Overtemp mode.

The UJA1161 exits Overtemp mode:

- and switches to Standby mode if the chip temperature falls below the overtemperature protection release threshold, $T_{th(rel)otp}$
- if the device is forced to switch to Off mode ($V_{BAT} < V_{th(det)poff}$)

6.1.1.5 Hardware characterization for the UJA1161 operating modes

Table 3. Hardware characterization by functional block

Block	Operating mode			
	Off	Standby	Normal	Overtemp
V_{BUF}	off	on/off ^[1]	on	off
CAN	off	Offline	Active	off
RXD	V_{IO} level	V_{IO} level/LOW if wake-up detected	CAN bit stream	V_{IO} level/LOW if wake-up detected

- [1] V_{BUF} is switched on in Standby mode if a CAN wake-up pattern is detected on the bus; if pin STBN does not go HIGH within $t_{to(silence)}$, V_{BUF} is switched off again. V_{BUF} is also switched on in Standby mode if STBN goes HIGH to select Normal mode.

6.1.2 Mode control via pin STBN

The UJA1161 can be switched between Normal and Standby modes via the STBN control input (see [Figure 3](#)). When STBN goes LOW, the UJA1161 switches to Standby mode. When STBN goes HIGH, the UJA1161 switches to Normal mode.

6.2 Power supplies

6.2.1 Battery supply voltage (V_{BAT})

The internal circuitry is supplied from the battery via pin BAT. The device needs to be protected against negative supply voltages, e.g. by using an external series diode. If V_{BAT} falls below the power-off detection threshold, $V_{th(det)pooff}$, the UJA1161 switches to Off mode, which means that the internal 5 V CAN supply and other internal logic (except for power-on detection) are shut down.

The UJA1161 switches from Off mode to Standby mode $t_{startup}$ after the battery voltage rises above the power-on detection threshold, $V_{th(det)pon}$. A power-on event is indicated by a LOW level on pin RXD. RXD remains LOW from the moment UJA1161 exits Off mode until it switches to Normal mode.

6.2.2 CAN supply voltage (V_{BUF})

V_{BUF} provides the internal CAN transceiver with a 5 V supply. The output voltage on BUF is monitored. If V_{BUF} falls below the 90 % undervoltage threshold (90 % of the nominal V_{BUF} output voltage), the CAN transceiver switches to (or remains in) Offline mode.

6.3 High-speed CAN transceiver

The integrated high-speed CAN transceiver is designed for active communication at bit rates up to 1 Mbit/s, providing differential transmit and receive capability to a CAN protocol controller. The transceiver is ISO 11898-2 and ISO 11898-5 compliant. The CAN transmitter is supplied from V_{BUF} . The UJA1161 includes additional timing parameters on loop delay symmetry to ensure reliable communication in fast phase at data rates up to 2 Mbit/s, as used in CAN FD networks.

The CAN transceiver supports autonomous CAN biasing as defined in ISO 11898-6, which helps to minimize RF emissions. CANH and CANL are always biased to 2.5 V when the UJA1161 is in Normal mode with $V_{BUF} > 90\%$ threshold.

Autonomous biasing is active when the UJA1161 is in Standby mode with the CAN transceiver in CAN Offline mode - to 2.5 V if there is activity on the bus (CAN Offline Bias mode) and to GND if there is no activity on the bus for $t > t_{to(silence)}$ (CAN Offline mode).

This is useful when the node is disabled due to a malfunction in the microcontroller. The transceiver ensures that the CAN bus is correctly biased to avoid disturbing ongoing communication between other nodes. The autonomous CAN bias voltage is derived directly from V_{BAT} .

6.3.1 CAN operating modes

The integrated CAN transceiver supports three operating modes: Active, Offline and Offline Bias (see [Figure 4](#)). The CAN transceiver operating mode depends on the UJA1161 operating mode and the output voltage on BUF.

6.3.1.1 CAN Active mode

In CAN Active mode, the transceiver can transmit and receive data via CANH and CANL. The differential receiver converts the analog data on the bus lines into digital data, which is output on pin RXD. The transmitter converts digital data generated by the CAN controller (input on pin TXD) into analog signals suitable for transmission over the CANH and CANL bus lines.

The CAN transceiver is in Active mode when:

- the UJA1161 is in Normal mode (STBN = 1) AND $V_{BUF} > V_{uvd(BUF)}$ AND $V_{IO} > V_{uvd(VIO)}$

In CAN Active mode, the CAN bias voltage is derived from V_{BUF} . If V_{BUF} falls below $V_{uvd(BUF)}$, the UJA1161 exits CAN Active mode and enters CAN Offline Bias mode with autonomous CAN voltage biasing via pin BAT.

If pin TXD is LOW when the transceiver switches to CAN Active mode (UJA1161 in Normal mode; V_{BUF} and V_{IO} ok), the transmitter and receiver will remain disabled until TXD goes HIGH. This prevents network traffic being blocked for $t_{to(dom)TXD}$ (i.e. while the TXD dominant time-out timer is running; see [Section 6.6.1](#)) every time the transceiver enters Active mode, if the TXD pin is clamped permanently LOW.

6.3.1.2 CAN Offline and Offline Bias modes

In CAN Offline mode, the transceiver monitors the CAN bus for a wake-up event. CANH and CANL are biased to GND.

CAN Offline Bias mode is the same as CAN Offline mode, with the exception that the CAN bus is biased to 2.5 V. This mode is activated automatically when activity is detected on the CAN bus while the transceiver is in CAN Offline mode. The transceiver will return to CAN Offline mode if the CAN bus is silent (no CAN bus edges) for longer than $t_{to(silence)}$.

The CAN transceiver switches to CAN Offline mode from CAN Active mode when:

- the UJA1161 switches to Standby mode

provided the CAN-bus has been inactive for at least $t_{to(silence)}$. If the CAN-bus has been inactive for less than $t_{to(silence)}$, the CAN transceiver switches first to CAN Offline Bias mode and then to CAN Offline mode once the bus has been silent for $t_{to(silence)}$.

The CAN transceiver will switch from CAN Active mode to CAN Offline Bias mode if:

- $V_{BUF} < V_{uvd(BUF)}$ OR $V_{IO} < V_{uvd(VIO)}$

The CAN transceiver switches to CAN Offline mode:

- from CAN Offline Bias mode when the UJA1161 is in Standby mode and no activity has been detected on the bus (no CAN edges) for $t > t_{to(silence)}$ OR
- when the UJA1161 switches from Off or Overtemp mode to Standby mode

The CAN transceiver switches from CAN Offline mode to CAN Offline Bias mode if:

- a standard wake-up pattern (according to ISO11898-5) is detected on the CAN bus OR
- the UJA1161 switches to Normal mode while $V_{BUF} < V_{uvd(BUF)}$ OR $V_{IO} < V_{uvd(VIO)}$

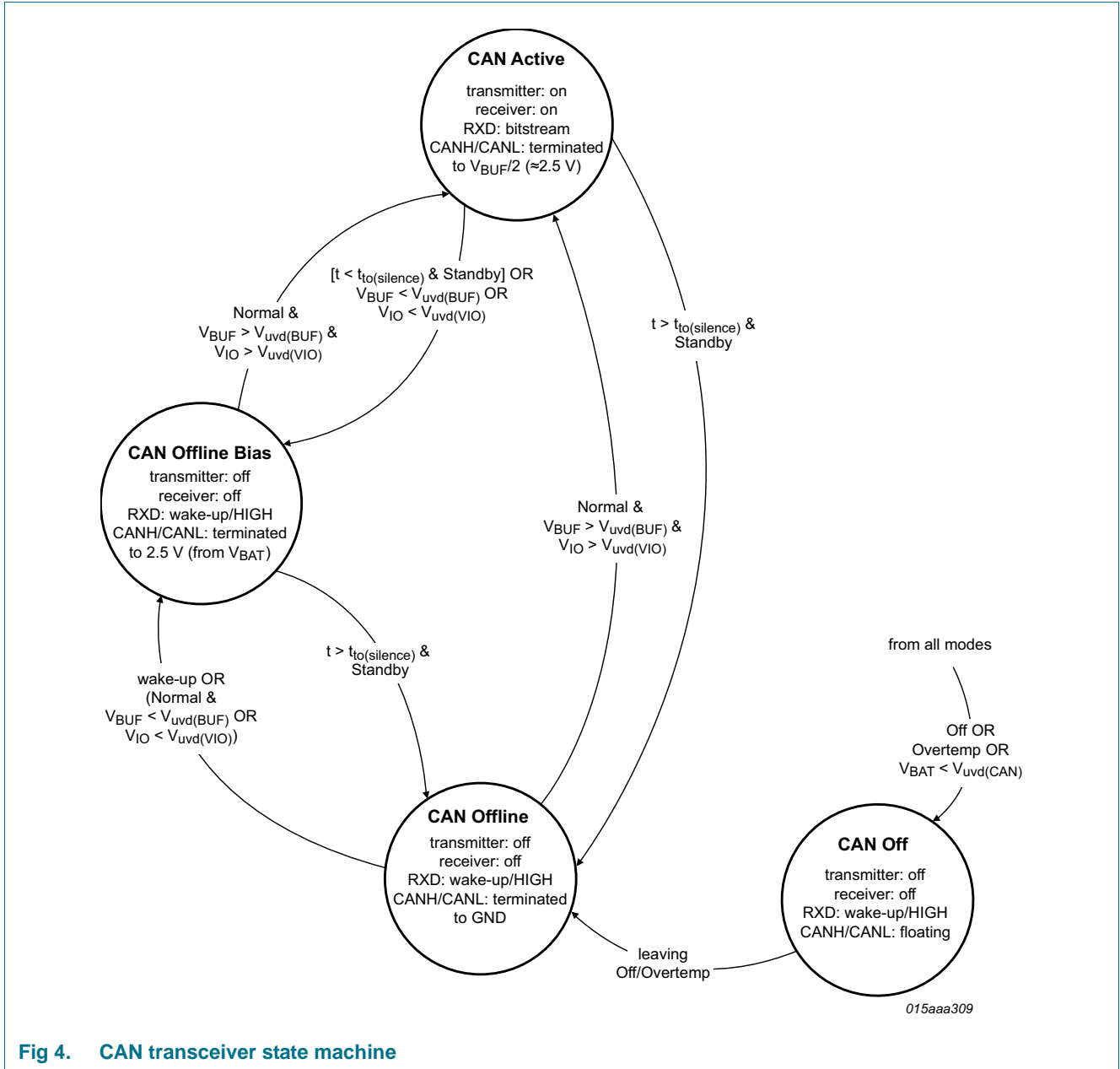

Fig 4. CAN transceiver state machine

6.3.1.3 CAN Off mode

The CAN transceiver is switched off completely with the bus lines floating when:

- the UJA1161 switches to Off or Overtemp mode OR
- V_{BAT} falls below the CAN receiver undervoltage detection threshold, $V_{uvd(CAN)}$

It will be switched on again on entering CAN Offline mode when V_{BAT} rises above the undervoltage recovery threshold ($V_{UVr(CAN)}$) and the UJA1161 is no longer in Off/Overtemp mode. CAN Off mode prevents reverse currents flowing from the bus when the battery supply to the UJA1161 is lost.

6.3.2 CAN standard wake-up

The UJA1161 monitors the bus for a wake-up pattern when the CAN transceiver is in Offline mode.

A filter at the receiver input prevents unwanted wake-up events occurring due to automotive transients or EMI. A dominant-recessive-dominant wake-up pattern must be transmitted on the CAN bus within the wake-up timeout time ($t_{to(wake)}$) to pass the wake-up filter and trigger a wake-up event (see Figure 5; note that additional pulses may occur between the recessive/dominant phases). The recessive and dominant phases must last at least $t_{wake(busrec)}$ and $t_{wake(busdom)}$, respectively.

Pin RXD is driven LOW when a valid CAN wake-up pattern is detected on the bus.

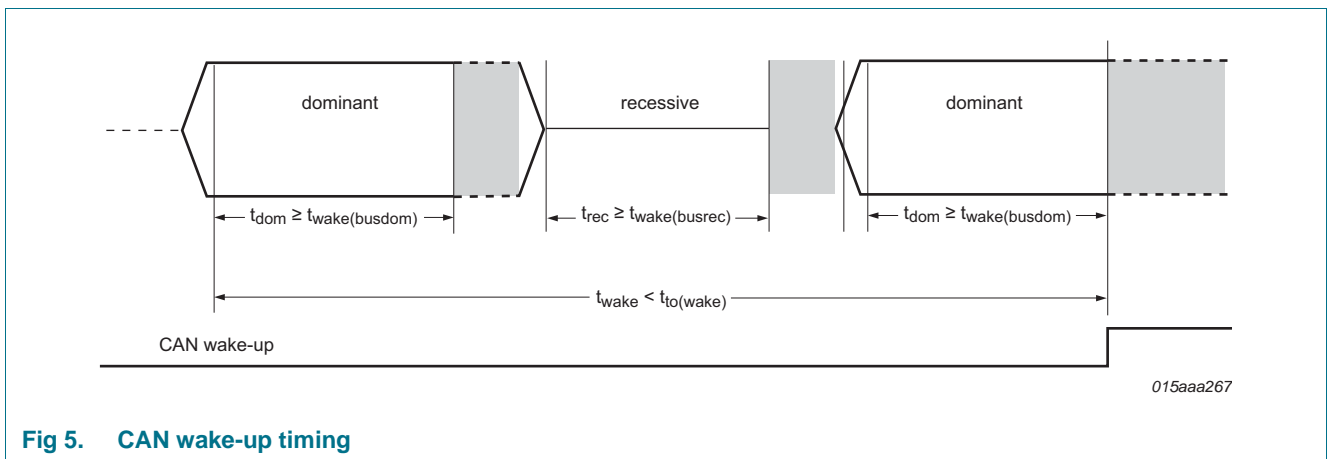

Fig 5. CAN wake-up timing

6.4 VIO supply pin

Pin VIO should be connected to the microcontroller supply voltage. This will cause the signal levels on TXD, RXD, STBN and CTS to be adjusted to the I/O levels of the microcontroller, enabling direct interfacing without the need for glue logic.

6.5 CAN transceiver status pin (CTS)

Pin CTS is driven HIGH to indicate to microcontroller that the transceiver is fully enabled and data can be transmitted and received via the TXD/RXD pins.

Pin CTS is actively driven LOW:

- while the transceiver is starting up (e.g. during a transition from Standby to Normal mode) or
- if pin TXD is clamped LOW for $t > t_{to(dom)TXD}$ or
- if an undervoltage is detected on VIO or BUF

6.6 CAN fail-safe features

6.6.1 TXD dominant timeout

A TXD dominant time-out timer is started when pin TXD is forced LOW while the transceiver is in CAN Active Mode. If the LOW state on pin TXD persists for longer than the TXD dominant time-out time ($t_{to(dom)TXD}$), the transmitter is disabled, releasing the bus lines to recessive state. This function prevents a hardware and/or software application failure from driving the bus lines to a permanent dominant state (blocking all network traffic). The TXD dominant time-out timer is reset when pin TXD goes HIGH. The TXD dominant time-out time also defines the minimum possible bit rate of 15 kbit/s.

6.6.2 Pull-up on TXD pin

Pin TXD has an internal pull-up (towards V_{IO}) to ensure a safe defined recessive driver state in case the pin is left floating.

6.6.3 Pull-down on STBN pin

Pin STBN has an internal pull-down (to GND) to ensure the UJA1161 switches to Standby mode if STBN is left floating.

6.6.4 Loss of power at pin BAT

A loss of power at pin BAT has no impact on the bus lines or on the microcontroller. No reverse currents flow from the bus.

7. Limiting values

Table 4. Limiting values

In accordance with the Absolute Maximum Rating System (IEC 60134).

Symbol	Parameter	Conditions	Min	Max	Unit
V _x	voltage on pin x	DC value			
		pins BUF ^[1] , VIO	-0.2	+6	V
		pins TXD, RXD, STBN, CTS	-0.2	V _{IO} + 0.2	V
		pin BAT	-0.2	+40	V
		pins CANH and CANL with respect to any other pin	-58	+58	V
V _(CANH-CANL)	voltage between pin CANH and pin CANL		-40	+40	V
V _{trt}	transient voltage	on pins BAT via reverse polarity diode and capacitor to ground CANL, CANH: coupling via 1 nF capacitors	^[2] -150	+100	V
V _{ESD}	electrostatic discharge voltage	IEC 61000-4-2	^[3]		
		on pins CANH and CANL; pin BAT with capacitor	-6	+6	kV
		HBM	^[4]		
		on pins CANH, CANL	^[5] -8	+8	kV
		on pin BAT	-4	+4	kV
		on any other pin	-2	+2	kV
		MM	^[6]		
		on any pin	-100	+100	V
		CDM	^[7]		
on corner pins	-750	+750	V		
on any other pin	-500	+500	V		
T _{vj}	virtual junction temperature		^[8] -40	+150	°C
T _{stg}	storage temperature		-55	+175	°C

[1] When the device is not powered up, I_{BUF(max)} = 25 mA.

[2] Verified by an external test house to ensure pins can withstand ISO 7637 part 2 automotive transient test pulses 1, 2a, 3a and 3b.

[3] ESD performance according to IEC 61000-4-2 (150 pF, 330 Ω) has been verified by an external test house for pins BAT, CANH and CANL; the result was equal to or better than ±6 kV.

[4] Human Body Model (HBM): according to AEC-Q100-002 (100 pF, 1.5 kΩ).

[5] Pins BUF and BAT connected to GND, emulating the application circuit.

[6] Machine Model (MM): according to AEC-Q100-003 (200 pF, 0.75 μH, 10 Ω).

[7] Charged Device Model (CDM): according to AEC-Q100-011 (field induced charge; 4 pF).

[8] In accordance with IEC 60747-1. An alternative definition of virtual junction temperature is: $T_{vj} = T_{amb} + P \times R_{th(j-a)}$, where $R_{th(j-a)}$ is a fixed value used in the calculation of T_{vj} . The rating for T_{vj} limits the allowable combinations of power dissipation (P) and ambient temperature (T_{amb}).

8. Thermal characteristics

Table 5. Thermal characteristics

Symbol	Parameter	Conditions	Typ	Unit
$R_{th(vj-a)}$	thermal resistance from virtual junction to ambient		[1] 60	K/W

[1] According to JEDEC JESD51-2, JESD51-5 and JESD51-7 at natural convection on 2s2p board. Board with two inner copper layers (thickness: 35 μm) and thermal via array under the exposed pad connected to the first inner copper layer (thickness: 70 μm).

9. Static characteristics

Table 6. Static characteristics

$T_{vj} = -40\text{ }^{\circ}\text{C}$ to $+150\text{ }^{\circ}\text{C}$; $V_{BAT} = 4.5\text{ V}$ to 28 V ; $V_{IO} = 2.85\text{ V}$ to 5.5 V ; $R_{(CANH-CANL)} = 60\ \Omega$; all voltages are defined with respect to ground; positive currents flow into the IC; typical values are given at $V_{BAT} = 13\text{ V}$; unless otherwise specified.

Symbol	Parameter	Conditions	Min	Typ	Max	Unit
Supply; pin BAT						
$V_{th(det)pon}$	power-on detection threshold voltage	V_{BAT} rising	4.2	-	4.55	V
$V_{th(det)poff}$	power-off detection threshold voltage	V_{BAT} falling	2.8	-	3	V
$V_{uvr(CAN)}$	CAN undervoltage recovery voltage	V_{BAT} rising	4.5	-	5	V
$V_{uvd(CAN)}$	CAN undervoltage detection voltage	V_{BAT} falling	4.2	-	4.55	V
I_{BAT}	battery supply current	Standby mode; CAN Offline mode; $-40\text{ }^{\circ}\text{C} < T_{vj} < +85\text{ }^{\circ}\text{C}$; $V_{BAT} = 7\text{ V}$ to 18 V	-	58	81	μA
		additional current in CAN Offline Bias mode; $-40\text{ }^{\circ}\text{C} < T_{vj} < 85\text{ }^{\circ}\text{C}$	-	46	63	μA
		Normal mode; CAN Active mode; CAN recessive; $V_{TXD} = V_{IO}$	-	4	7.5	mA
		Normal mode; CAN Active mode; CAN dominant; $V_{TXD} = 0\text{ V}$	-	46	67	mA
Voltage source; pin BUF						
V_O	output voltage	$V_{BAT} = 5.5\text{ V}$ to 18 V	4.9	5	5.1	V
V_{uvd}	undervoltage detection voltage		4.5	-	4.75	V
$I_{O(sc)}$	short-circuit output current		-300	-	-150	mA
Supply; pin VIO						
V_{uvd}	undervoltage detection voltage		2.7	-	2.85	V
$I_{I(VIO)}$	input current on pin VIO	Standby/Normal mode; $-40\text{ }^{\circ}\text{C} < T_{vj} < 85\text{ }^{\circ}\text{C}$	-	7.1	11	μA
Standby mode control input; pin STBN						
$V_{th(sw)}$	switching threshold voltage		$0.25V_{IO}$	-	$0.75V_{IO}$	V
R_{pd}	pull-down resistance		40	60	80	$\text{k}\Omega$

Self-supplied high-speed CAN transceiver with Standby mode

Table 6. Static characteristics ...continued

$T_{vj} = -40\text{ }^{\circ}\text{C}$ to $+150\text{ }^{\circ}\text{C}$; $V_{BAT} = 4.5\text{ V}$ to 28 V ; $V_{IO} = 2.85\text{ V}$ to 5.5 V ; $R_{(CANH-CANL)} = 60\text{ }\Omega$; all voltages are defined with respect to ground; positive currents flow into the IC; typical values are given at $V_{BAT} = 13\text{ V}$; unless otherwise specified.

Symbol	Parameter	Conditions	Min	Typ	Max	Unit
CAN transmit data input; pin TXD						
$V_{th(sw)}$	switching threshold voltage		$0.25V_{IO}$	-	$0.75V_{IO}$	V
R_{pu}	pull-up resistance		40	60	80	k Ω
CAN transmitter status; pin CTS						
I_{OH}	HIGH-level output current	$V_{CTS} = V_{IO} - 0.4\text{ V}$; transmitter on	-	-	-4	mA
I_{OL}	LOW-level output current	$V_{CTS} = 0.4\text{ V}$; transmitter off	4	-	-	mA
CAN receive data output; pin RXD						
V_{OH}	HIGH-level output voltage	$I_{OH} = -4\text{ mA}$	$V_{IO} - 0.4$	-	-	V
V_{OL}	LOW-level output voltage	$I_{OL} = 4\text{ mA}$	-	-	0.4	V
R_{pu}	pull-up resistance	CAN Offline mode	40	60	80	k Ω
High-speed CAN bus lines; pins CANH and CANL						
$V_{O(dom)}$	dominant output voltage	CAN Active mode; $V_{TXD} = 0\text{ V}$; $V_{BAT} > 5.5\text{ V}$				
		pin CANH	2.75	3.5	4.5	V
		pin CANL	0.5	1.5	2.25	V
V_{TXsym}	transmitter voltage symmetry	$V_{TXsym} = V_{CANH} + V_{CANL}$; $f_{TXD} = 250\text{ kHz}$; $C_{SPLIT} = 4.7\text{ nF}$	$0.9V_{BUF}$	-	$1.1V_{BUF}$	V
$V_{dom(TX)sym}$	transmitter dominant voltage symmetry	$V_{dom(TX)sym} = V_{BUF} - V_{CANH} - V_{CANL}$; $V_{BAT} > 5.5\text{ V}$	-400	-	+400	mV
$V_{O(dif)bus}$	bus differential output voltage	CAN Active mode (dominant); $V_{TXD} = 0\text{ V}$; $V_{BAT} > 5.5\text{ V}$; $R_{(CANH-CANL)} = 45\text{ }\Omega$ to $65\text{ }\Omega$	1.5	-	3.0	V
		CAN Active mode (recessive); CAN Offline mode; $V_{TXD} = V_{IO}$; $R_{(CANH-CANL)} = \text{no load}$; $V_{BAT} > 5.5\text{ V}$; $T_{vj} < 150\text{ }^{\circ}\text{C}$	-50	-	+50	mV
$V_{O(rec)}$	recessive output voltage	CAN Active mode; $V_{TXD} = V_{IO}$; $V_{BAT} > 5.5\text{ V}$; $R_{(CANH-CANL)} = \text{no load}$	2	$0.5V_{BUF}$	3	V
		CAN Offline mode; $V_{BAT} > 5.5\text{ V}$; $R_{(CANH-CANL)} = \text{no load}$	-0.1	-	+0.1	V
		CAN Offline Bias mode; $R_{(CANH-CANL)} = \text{no load}$	2	2.5	3	V
$I_{O(dom)}$	dominant output current	CAN Active mode; $V_{TXD} = 0\text{ V}$; $V_{BAT} > 5.5\text{ V}$				
		pin CANH; $V_{CANH} = 0\text{ V}$	-50	-	-	mA
		pin CANL; $V_{CANL} = 5\text{ V}$	-	-	52	mA
$I_{O(rec)}$	recessive output current	$V_{CANL} = V_{CANH} = -27\text{ V}$ to $+32\text{ V}$; $V_{TXD} = V_{IO}$	-3	-	+3	mA

Self-supplied high-speed CAN transceiver with Standby mode

Table 6. Static characteristics ...continued

$T_{vj} = -40\text{ °C}$ to $+150\text{ °C}$; $V_{BAT} = 4.5\text{ V}$ to 28 V ; $V_{IO} = 2.85\text{ V}$ to 5.5 V ; $R_{(CANH-CANL)} = 60\ \Omega$; all voltages are defined with respect to ground; positive currents flow into the IC; typical values are given at $V_{BAT} = 13\text{ V}$; unless otherwise specified.

Symbol	Parameter	Conditions	Min	Typ	Max	Unit
$V_{th(RX)dif}$	differential receiver threshold voltage	CAN Active mode; $V_{CANL} = V_{CANH} = -12\text{ V}$ to $+12\text{ V}$; $V_{BAT} > 5.5\text{ V}$	0.5	0.7	0.9	V
		CAN Offline mode; $V_{CANL} = V_{CANH} = -12\text{ V}$ to $+12\text{ V}$; $V_{BAT} > 5.5\text{ V}$	0.4	0.7	1.15	V
$V_{hys(RX)dif}$	differential receiver hysteresis voltage	CAN Active mode; $V_{CANL} = V_{CANH} = -12\text{ V}$ to $+12\text{ V}$; $V_{BAT} > 5.5\text{ V}$	50	200	400	mV
$R_{i(cm)}$	common-mode input resistance		9	15	28	k Ω
ΔR_i	input resistance deviation		-1	-	+1	%
$R_{i(dif)}$	differential input resistance		19	30	52	k Ω
$C_{i(cm)}$	common-mode input capacitance		[1]	-	20	pF
$C_{i(dif)}$	differential input capacitance		[1]	-	10	pF
I_{LI}	input leakage current	$V_{BAT} = V_{BUF} = 0\text{ V}$ or $V_{BAT} = V_{BUF} =$ shorted to ground via $47\text{ k}\Omega$; $V_{CANH} = V_{CANL} = 5\text{ V}$	-5	-	+5	μA
Temperature protection						
$T_{th(act)otp}$	overtemperature protection activation threshold temperature		167	177	187	$^{\circ}\text{C}$
$T_{th(rel)otp}$	overtemperature protection release threshold temperature		127	137	147	$^{\circ}\text{C}$

[1] Not tested in production; guaranteed by design.

[2] The test circuit used to measure the bus output voltage symmetry (which includes C_{SPLIT}) is shown in [Figure 10](#).

10. Dynamic characteristics

Table 7. Dynamic characteristics

$T_{vj} = -40\text{ °C to }+150\text{ °C}$; $V_{BAT} = 4.5\text{ V to }28\text{ V}$; $V_{IO} = 2.85\text{ V to }5.5\text{ V}$; $R_{(CANH-CANL)} = 60\ \Omega$; all voltages are defined with respect to ground; positive currents flow into the IC; typical values are given at $V_{BAT} = 13\text{ V}$; unless otherwise specified.

Symbol	Parameter	Conditions	Min	Typ	Max	Unit
Voltage sources; pins BUF and VIO						
$t_{startup}$	start-up time	from V_{BAT} exceeding the power-on detection threshold until $V_{BUF} > 90\%$ undervoltage threshold; $C_{BUF} = 4.7\ \mu\text{F}$	-	2.8	4.7	ms
$t_{d(uvd)}$	undervoltage detection delay time		6	-	54	μs
Mode control: pin STBN						
$t_{ftr(stb)}$	standby filter time		2.5	-	13.5	μs
CAN transceiver timing; pins CANH, CANL, TXD and RXD						
$t_{d(TXD-RXD)}$	delay time from TXD to RXD	$R_L = 60\ \Omega$; $C_L = 100\ \text{pF}$; 50 % V_{TXD} to 50 % V_{RXD} ; $C_{RXD} = 15\ \text{pF}$; $f_{TXD} = 250\ \text{kHz}$	-	-	255	ns
		$R_L = 120\ \Omega$; $C_L = 200\ \text{pF}$; 50 % V_{TXD} to 50 % V_{RXD} ; $C_{RXD} = 15\ \text{pF}$; $f_{TXD} = 250\ \text{kHz}$	[1]	-	350	ns
$t_{d(TXD-busdom)}$	delay time from TXD to bus dominant		-	80	-	ns
$t_{d(TXD-busrec)}$	delay time from TXD to bus recessive		-	80	-	ns
$t_{d(busdom-RXD)}$	delay time from bus dominant to RXD	$C_{RXD} = 15\ \text{pF}$	-	105	-	ns
$t_{d(busrec-RXD)}$	delay time from bus recessive to RXD	$C_{RXD} = 15\ \text{pF}$	-	120	-	ns
$t_{bit(RXD)}$	bit time on pin RXD	$t_{bit(TXD)} = 500\ \text{ns}$	[2]	400	-	550 ns
$t_{wake(busdom)}$	bus dominant wake-up time	first pulse (after first recessive) for wake-up on pins CANH and CANL; CAN Offline mode	0.5	-	3.0	μs
		second pulse for wake-up on pins CANH and CANL	0.5	-	3.0	μs
$t_{wake(busrec)}$	bus recessive wake-up time	first pulse for wake-up on pins CANH and CANL; CAN Offline mode	0.5	-	3.0	μs
		second pulse (after first dominant) for wake-up on pins CANH and CANL	0.5	-	3.0	μs
$t_{to(wake)}$	wake-up time-out time	between first and second dominant pulses; CAN Offline mode	570	-	1200	μs
$t_{to(dom)TXD}$	TXD dominant time-out time	CAN Active mode; $V_{TXD} = 0\text{ V}$	2.7	-	3.3	ms
$t_{to(silence)}$	bus silence time-out time	recessive time measurement started in all CAN modes; $R_L = 120\ \Omega$	0.95	-	1.17	s
$t_{d(busact-bias)}$	delay time from bus active to bias		-	-	200	μs
$t_{startup(CAN)}$	CAN start-up time	when switching to Active mode (CTS = HIGH)	-	-	220	μs

- [1] Guaranteed by design.
- [2] See [Figure 7](#).

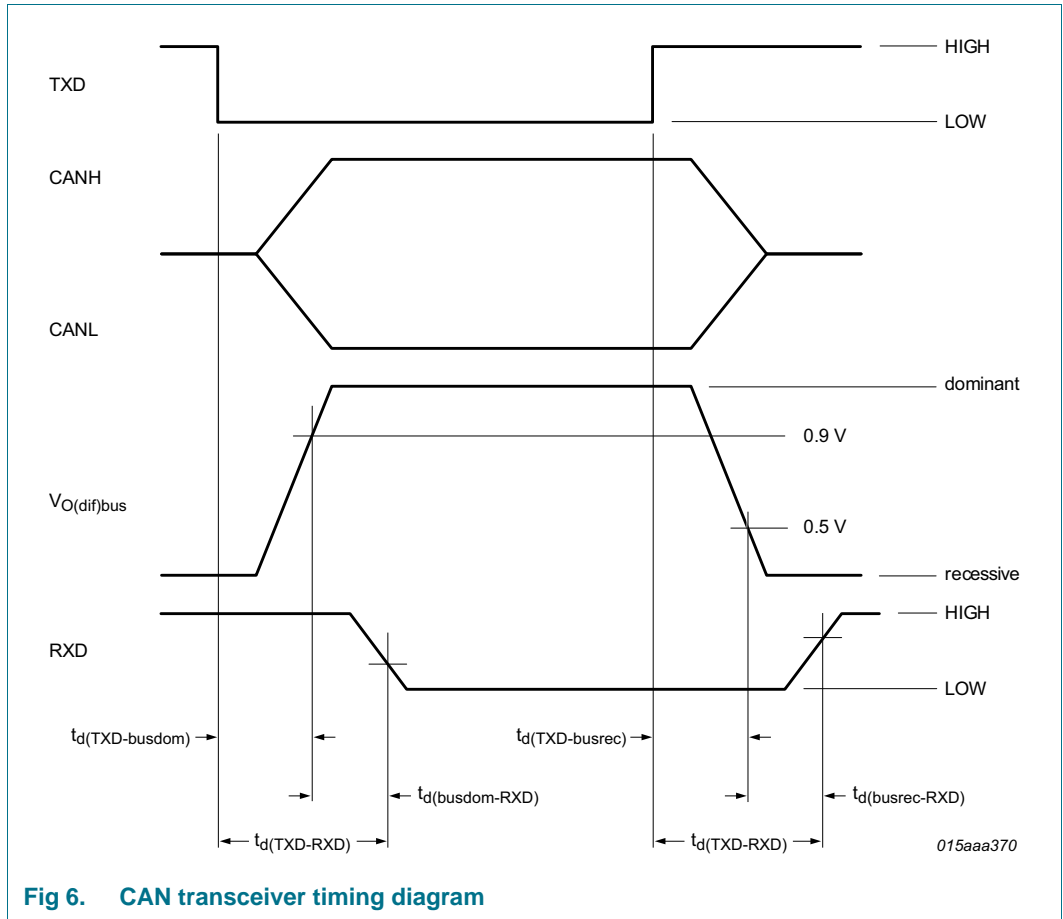

Fig 6. CAN transceiver timing diagram

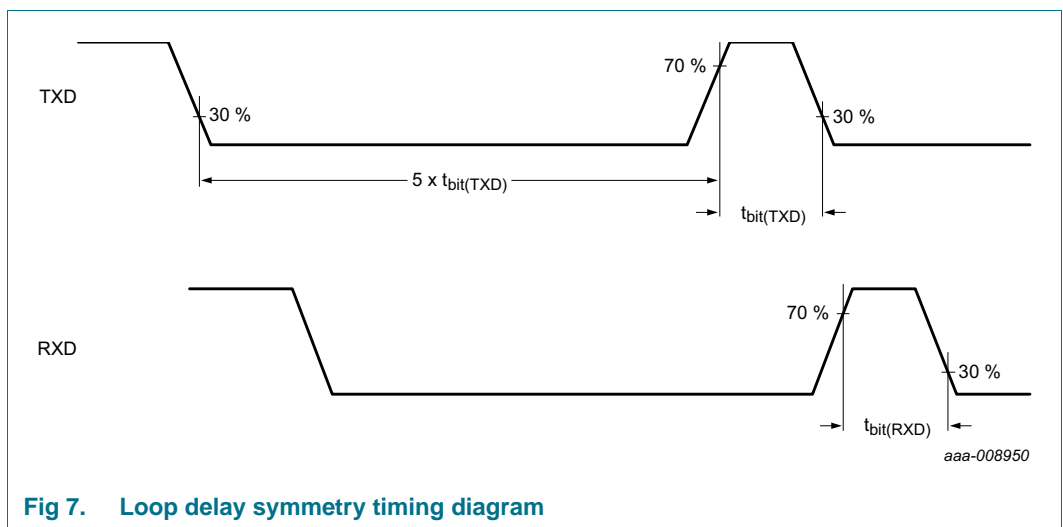
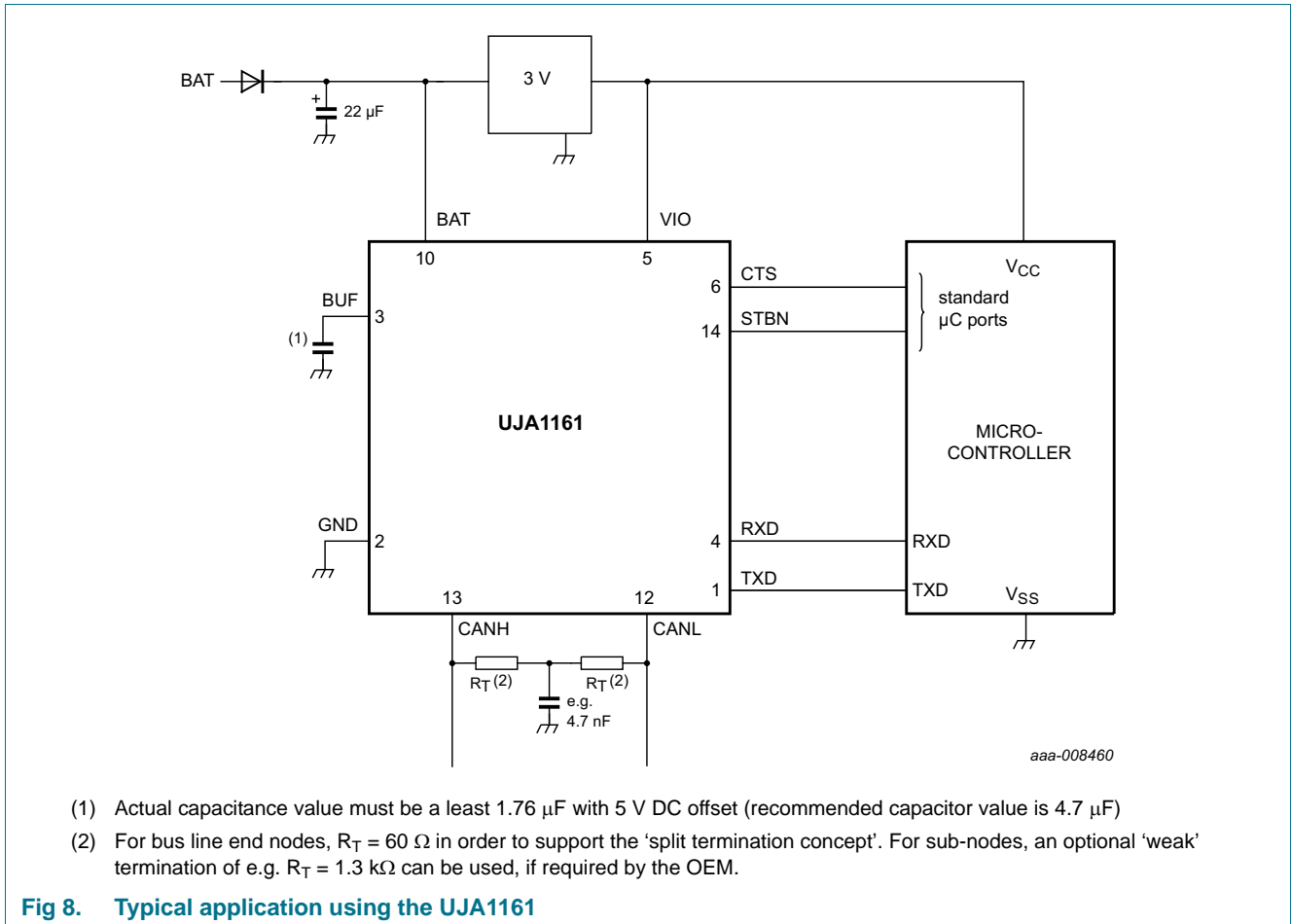

Fig 7. Loop delay symmetry timing diagram

11. Application information

11.1 Application diagram



12. Test information

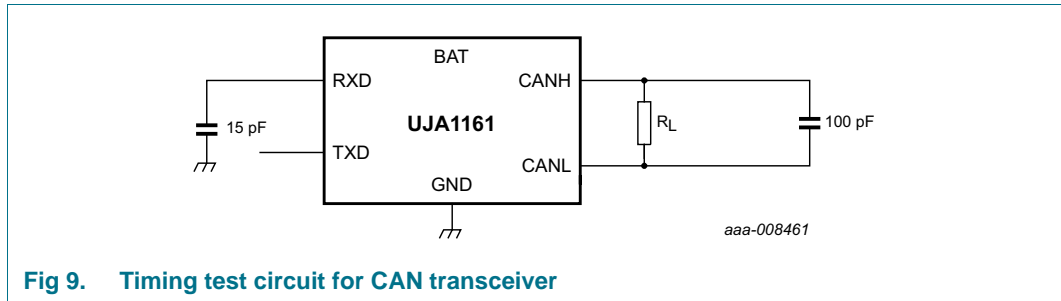

Fig 9. Timing test circuit for CAN transceiver

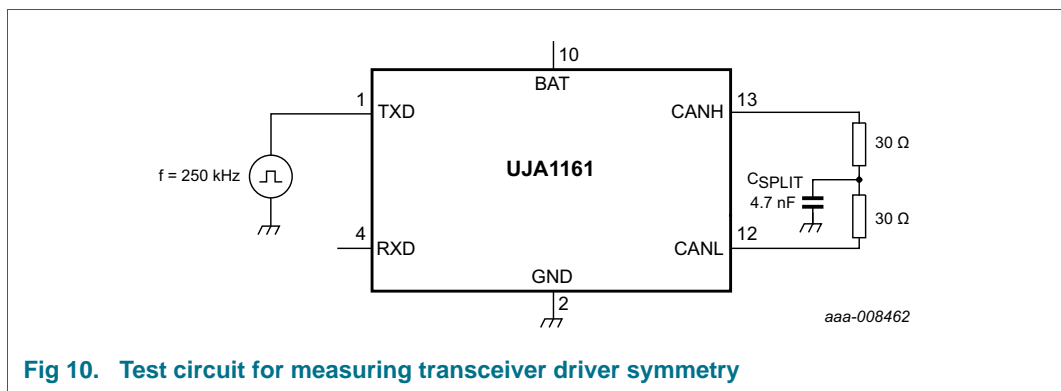

Fig 10. Test circuit for measuring transceiver driver symmetry

12.1 Quality information

This product has been qualified in accordance with the Automotive Electronics Council (AEC) standard Q100 Rev-G - *Failure mechanism based stress test qualification for integrated circuits*, and is suitable for use in automotive applications.

13. Package outline

HVSON14: plastic, thermal enhanced very thin small outline package; no leads; 14 terminals; body 3 x 4.5 x 0.85 mm

SOT1086-2

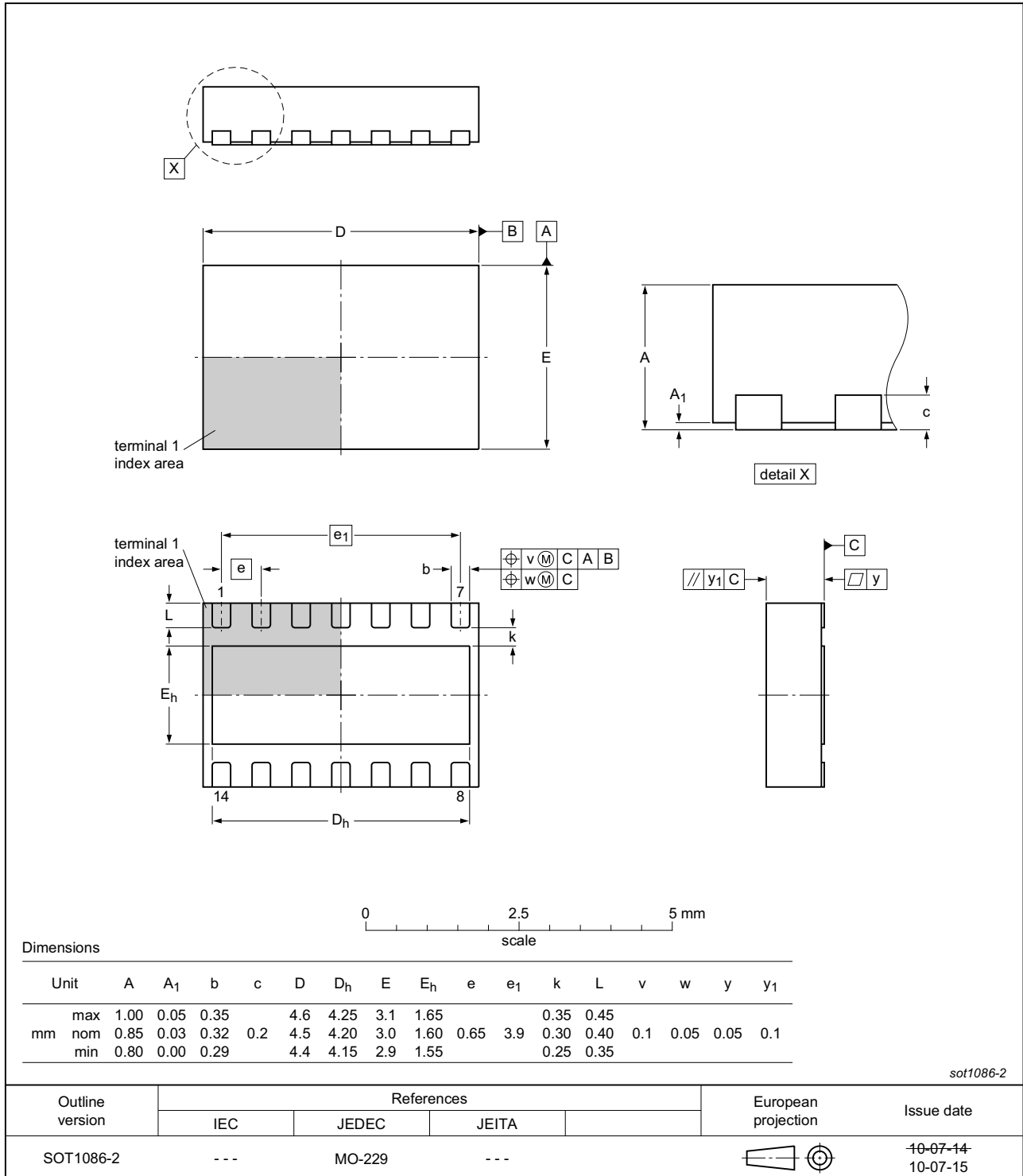

Fig 11. Package outline SOT1086-2 (HVSON14)

14. Handling information

All input and output pins are protected against ElectroStatic Discharge (ESD) under normal handling. When handling ensure that the appropriate precautions are taken as described in *JESD625-A* or equivalent standards.

15. Soldering of SMD packages

This text provides a very brief insight into a complex technology. A more in-depth account of soldering ICs can be found in Application Note *AN10365 "Surface mount reflow soldering description"*.

15.1 Introduction to soldering

Soldering is one of the most common methods through which packages are attached to Printed Circuit Boards (PCBs), to form electrical circuits. The soldered joint provides both the mechanical and the electrical connection. There is no single soldering method that is ideal for all IC packages. Wave soldering is often preferred when through-hole and Surface Mount Devices (SMDs) are mixed on one printed wiring board; however, it is not suitable for fine pitch SMDs. Reflow soldering is ideal for the small pitches and high densities that come with increased miniaturization.

15.2 Wave and reflow soldering

Wave soldering is a joining technology in which the joints are made by solder coming from a standing wave of liquid solder. The wave soldering process is suitable for the following:

- Through-hole components
- Leaded or leadless SMDs, which are glued to the surface of the printed circuit board

Not all SMDs can be wave soldered. Packages with solder balls, and some leadless packages which have solder lands underneath the body, cannot be wave soldered. Also, leaded SMDs with leads having a pitch smaller than ~0.6 mm cannot be wave soldered, due to an increased probability of bridging.

The reflow soldering process involves applying solder paste to a board, followed by component placement and exposure to a temperature profile. Leaded packages, packages with solder balls, and leadless packages are all reflow solderable.

Key characteristics in both wave and reflow soldering are:

- Board specifications, including the board finish, solder masks and vias
- Package footprints, including solder thieves and orientation
- The moisture sensitivity level of the packages
- Package placement
- Inspection and repair
- Lead-free soldering versus SnPb soldering

15.3 Wave soldering

Key characteristics in wave soldering are:

- Process issues, such as application of adhesive and flux, clinching of leads, board transport, the solder wave parameters, and the time during which components are exposed to the wave
- Solder bath specifications, including temperature and impurities

15.4 Reflow soldering

Key characteristics in reflow soldering are:

- Lead-free versus SnPb soldering; note that a lead-free reflow process usually leads to higher minimum peak temperatures (see [Figure 12](#)) than a SnPb process, thus reducing the process window
- Solder paste printing issues including smearing, release, and adjusting the process window for a mix of large and small components on one board
- Reflow temperature profile; this profile includes preheat, reflow (in which the board is heated to the peak temperature) and cooling down. It is imperative that the peak temperature is high enough for the solder to make reliable solder joints (a solder paste characteristic). In addition, the peak temperature must be low enough that the packages and/or boards are not damaged. The peak temperature of the package depends on package thickness and volume and is classified in accordance with [Table 8](#) and [9](#)

Table 8. SnPb eutectic process (from J-STD-020D)

Package thickness (mm)	Package reflow temperature (°C)	
	Volume (mm ³)	
	< 350	≥ 350
< 2.5	235	220
≥ 2.5	220	220

Table 9. Lead-free process (from J-STD-020D)

Package thickness (mm)	Package reflow temperature (°C)		
	Volume (mm ³)		
	< 350	350 to 2000	> 2000
< 1.6	260	260	260
1.6 to 2.5	260	250	245
> 2.5	250	245	245

Moisture sensitivity precautions, as indicated on the packing, must be respected at all times.

Studies have shown that small packages reach higher temperatures during reflow soldering, see [Figure 12](#).

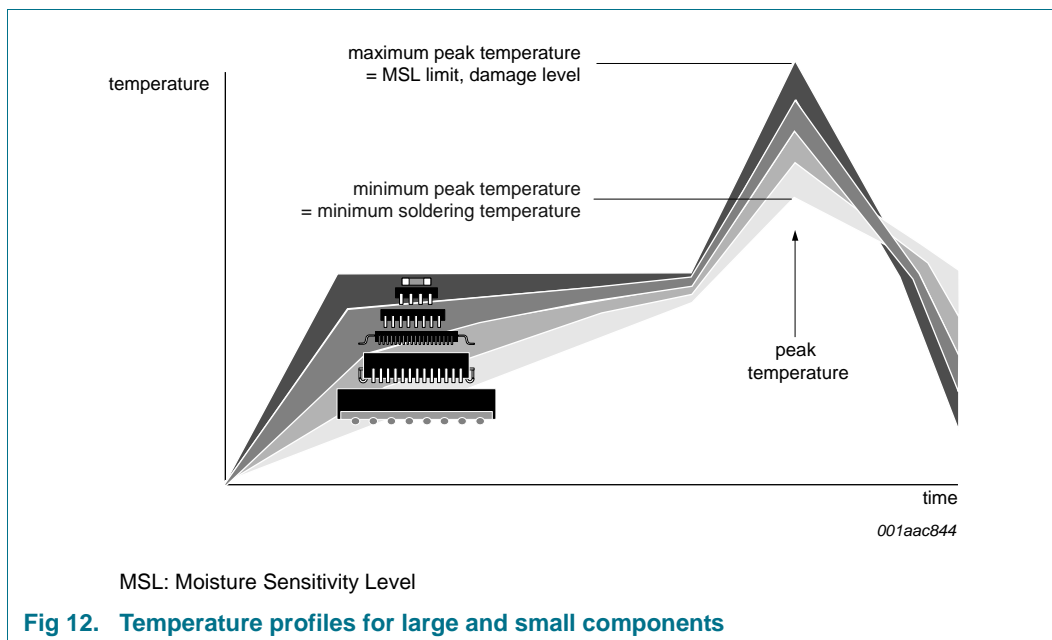

For further information on temperature profiles, refer to Application Note *AN10365* “*Surface mount reflow soldering description*”.

16. Soldering of HVSON packages

[Section 15](#) contains a brief introduction to the techniques most commonly used to solder Surface Mounted Devices (SMD). A more detailed discussion on soldering HVSON leadless package ICs can be found in the following application notes:

- *AN10365* “*Surface mount reflow soldering description*”
- *AN10366* “*HVQFN application information*”

17. Revision history

Table 10. Revision history

Document ID	Release date	Data sheet status	Change notice	Supersedes
UJA1161 v.2	20140417	Product data sheet	-	UJA1161 v.1
Modifications:	<ul style="list-style-type: none"> • Section 1: text revised (2nd paragraph added) • Section 2.1: feature added (loop delay symmetry) • Figure 1: amended • Table 2: CTS pin description changed; table note amended • Table 3: row CAN revised • Section 6.3: text and state diagram revised • Section 6.5: text revised • Table 7: conditions revised for symbol $t_{startup}$; parameter values changed: $t_{d(uvd)}$; parameter $t_{bit(RXD)}$ added; additional measurement for parameter $t_{d(TXD-RXD)}$ • Figure 7: added • Section 12.1: text updated • Fig. 10 deleted 			
UJA1161 v.1	20130926	Product data sheet	-	-

18. Legal information

18.1 Data sheet status

Document status ^{[1][2]}	Product status ^[3]	Definition
Objective [short] data sheet	Development	This document contains data from the objective specification for product development.
Preliminary [short] data sheet	Qualification	This document contains data from the preliminary specification.
Product [short] data sheet	Production	This document contains the product specification.

[1] Please consult the most recently issued document before initiating or completing a design.

[2] The term 'short data sheet' is explained in section "Definitions".

[3] The product status of device(s) described in this document may have changed since this document was published and may differ in case of multiple devices. The latest product status information is available on the Internet at URL <http://www.nxp.com>.

18.2 Definitions

Draft — The document is a draft version only. The content is still under internal review and subject to formal approval, which may result in modifications or additions. NXP Semiconductors does not give any representations or warranties as to the accuracy or completeness of information included herein and shall have no liability for the consequences of use of such information.

Short data sheet — A short data sheet is an extract from a full data sheet with the same product type number(s) and title. A short data sheet is intended for quick reference only and should not be relied upon to contain detailed and full information. For detailed and full information see the relevant full data sheet, which is available on request via the local NXP Semiconductors sales office. In case of any inconsistency or conflict with the short data sheet, the full data sheet shall prevail.

Product specification — The information and data provided in a Product data sheet shall define the specification of the product as agreed between NXP Semiconductors and its customer, unless NXP Semiconductors and customer have explicitly agreed otherwise in writing. In no event however, shall an agreement be valid in which the NXP Semiconductors product is deemed to offer functions and qualities beyond those described in the Product data sheet.

18.3 Disclaimers

Limited warranty and liability — Information in this document is believed to be accurate and reliable. However, NXP Semiconductors does not give any representations or warranties, expressed or implied, as to the accuracy or completeness of such information and shall have no liability for the consequences of use of such information. NXP Semiconductors takes no responsibility for the content in this document if provided by an information source outside of NXP Semiconductors.

In no event shall NXP Semiconductors be liable for any indirect, incidental, punitive, special or consequential damages (including - without limitation - lost profits, lost savings, business interruption, costs related to the removal or replacement of any products or rework charges) whether or not such damages are based on tort (including negligence), warranty, breach of contract or any other legal theory.

Notwithstanding any damages that customer might incur for any reason whatsoever, NXP Semiconductors' aggregate and cumulative liability towards customer for the products described herein shall be limited in accordance with the *Terms and conditions of commercial sale* of NXP Semiconductors.

Right to make changes — NXP Semiconductors reserves the right to make changes to information published in this document, including without limitation specifications and product descriptions, at any time and without notice. This document supersedes and replaces all information supplied prior to the publication hereof.

Suitability for use in automotive applications — This NXP Semiconductors product has been qualified for use in automotive applications. Unless otherwise agreed in writing, the product is not designed, authorized or warranted to be suitable for use in life support, life-critical or safety-critical systems or equipment, nor in applications where failure or malfunction of an NXP Semiconductors product can reasonably be expected to result in personal injury, death or severe property or environmental damage. NXP Semiconductors and its suppliers accept no liability for inclusion and/or use of NXP Semiconductors products in such equipment or applications and therefore such inclusion and/or use is at the customer's own risk.

Applications — Applications that are described herein for any of these products are for illustrative purposes only. NXP Semiconductors makes no representation or warranty that such applications will be suitable for the specified use without further testing or modification.

Customers are responsible for the design and operation of their applications and products using NXP Semiconductors products, and NXP Semiconductors accepts no liability for any assistance with applications or customer product design. It is customer's sole responsibility to determine whether the NXP Semiconductors product is suitable and fit for the customer's applications and products planned, as well as for the planned application and use of customer's third party customer(s). Customers should provide appropriate design and operating safeguards to minimize the risks associated with their applications and products.

NXP Semiconductors does not accept any liability related to any default, damage, costs or problem which is based on any weakness or default in the customer's applications or products, or the application or use by customer's third party customer(s). Customer is responsible for doing all necessary testing for the customer's applications and products using NXP Semiconductors products in order to avoid a default of the applications and the products or of the application or use by customer's third party customer(s). NXP does not accept any liability in this respect.

Limiting values — Stress above one or more limiting values (as defined in the Absolute Maximum Ratings System of IEC 60134) will cause permanent damage to the device. Limiting values are stress ratings only and (proper) operation of the device at these or any other conditions above those given in the Recommended operating conditions section (if present) or the Characteristics sections of this document is not warranted. Constant or repeated exposure to limiting values will permanently and irreversibly affect the quality and reliability of the device.

Terms and conditions of commercial sale — NXP Semiconductors products are sold subject to the general terms and conditions of commercial sale, as published at <http://www.nxp.com/profile/terms>, unless otherwise agreed in a valid written individual agreement. In case an individual agreement is concluded only the terms and conditions of the respective agreement shall apply. NXP Semiconductors hereby expressly objects to applying the customer's general terms and conditions with regard to the purchase of NXP Semiconductors products by customer.

No offer to sell or license — Nothing in this document may be interpreted or construed as an offer to sell products that is open for acceptance or the grant, conveyance or implication of any license under any copyrights, patents or other industrial or intellectual property rights.

Export control — This document as well as the item(s) described herein may be subject to export control regulations. Export might require a prior authorization from competent authorities.

Translations — A non-English (translated) version of a document is for reference only. The English version shall prevail in case of any discrepancy between the translated and English versions.

18.4 Trademarks

Notice: All referenced brands, product names, service names and trademarks are the property of their respective owners.

19. Contact information

For more information, please visit: <http://www.nxp.com>

For sales office addresses, please send an email to: salesaddresses@nxp.com

20. Contents

1	General description	1	12.1	Quality information	19
2	Features and benefits	1	13	Package outline	20
2.1	General	1	14	Handling information	21
2.2	Designed for automotive applications	1	15	Soldering of SMD packages	21
2.3	Integrated supply voltage for the CAN transceiver (V_{BUF})	2	15.1	Introduction to soldering	21
2.4	Power Management	2	15.2	Wave and reflow soldering	21
2.5	System control and diagnostic features	2	15.3	Wave soldering	21
3	Ordering information	2	15.4	Reflow soldering	22
4	Block diagram	3	16	Soldering of HVSON packages	23
5	Pinning information	4	17	Revision history	24
5.1	Pinning	4	18	Legal information	25
5.2	Pin description	4	18.1	Data sheet status	25
6	Functional description	5	18.2	Definitions	25
6.1	System controller	5	18.3	Disclaimers	25
6.1.1	Operating modes	5	18.4	Trademarks	26
6.1.1.1	Normal mode	5	19	Contact information	26
6.1.1.2	Standby mode	6	20	Contents	27
6.1.1.3	Off mode	6			
6.1.1.4	Overtemp mode	6			
6.1.1.5	Hardware characterization for the UJA1161 operating modes	6			
6.1.2	Mode control via pin STBN	7			
6.2	Power supplies	7			
6.2.1	Battery supply voltage (V_{BAT})	7			
6.2.2	CAN supply voltage (V_{BUF})	7			
6.3	High-speed CAN transceiver	7			
6.3.1	CAN operating modes	8			
6.3.1.1	CAN Active mode	8			
6.3.1.2	CAN Offline and Offline Bias modes	8			
6.3.1.3	CAN Off mode	9			
6.3.2	CAN standard wake-up	10			
6.4	VIO supply pin	10			
6.5	CAN transceiver status pin (CTS)	10			
6.6	CAN fail-safe features	11			
6.6.1	TXD dominant timeout	11			
6.6.2	Pull-up on TXD pin	11			
6.6.3	Pull-down on STBN pin	11			
6.6.4	Loss of power at pin BAT	11			
7	Limiting values	12			
8	Thermal characteristics	13			
9	Static characteristics	13			
10	Dynamic characteristics	16			
11	Application information	18			
11.1	Application diagram	18			
12	Test information	19			

Please be aware that important notices concerning this document and the product(s) described herein, have been included in section 'Legal information'.

© NXP Semiconductors N.V. 2014.

All rights reserved.

For more information, please visit: <http://www.nxp.com>



For sales office addresses, please send an email to: salesaddresses@nxp.com

Date of release: 17 April 2014

Document identifier: UJA1161

Looking for pricing, stock, or lifecycle information?

Click below to explore more details on WIN SOURCE:

-  [View UJA1161TK,118 on WIN SOURCE](#)
-  [NXP / Nexperia Information](#)

Optimize Your Supply Chain with WIN SOURCE Solutions

-  Global Sourcing Solution
-  Obsolete Management
-  Cost Control Management
-  Shortage Management
-  Alternative Solution
-  Excess Inventory Management