



THE DATASHEET OF TPSMC33CA



TPSMC Series

Surface Mount - 1500W

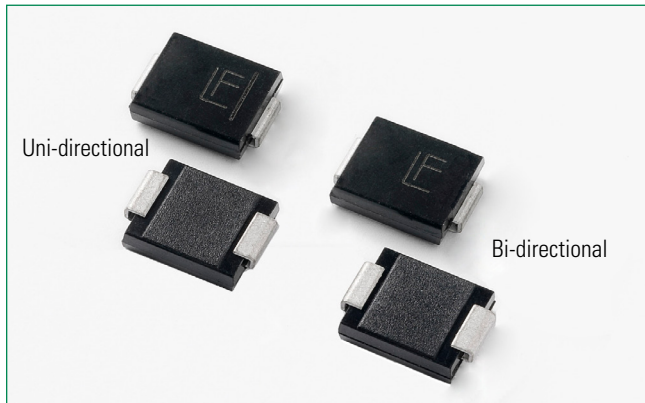

Agency Approvals

| Agency | Agency File Number |
|--------|--------------------|
| | E230531 |

Maximum Ratings & Thermal Characteristics

($T_A=25^\circ\text{C}$ unless otherwise noted)

| Parameter | Symbol | Value | Unit |
|--|-----------------|------------|--------------------|
| Peak Pulse Power Dissipation by 10/1000 μs Waveform (Fig.2)(Note 1), (Note 2) | P_{PPM} | 1500 | W |
| Power Dissipation on Infinite Heat Sink at $T_A=50^\circ\text{C}$ | $P_{M(AV)}$ | 6.5 | W |
| Peak Forward Surge Current, 8.3ms Single Half Sine Wave (Note 3) | I_{FSM} | 200 | A |
| Maximum Instantaneous Forward Voltage at 100A for Unidirectional Only | V_F | 3.5 | V |
| Operating Junction and Storage Temperature Range | T_J, T_{STG} | -65 to 150 | $^\circ\text{C}$ |
| Typical Thermal Resistance Junction to Lead | $R_{\theta JL}$ | 15 | $^\circ\text{C/W}$ |
| Typical Thermal Resistance Junction to Ambient | $R_{\theta JA}$ | 75 | $^\circ\text{C/W}$ |

Notes:

- Non-repetitive current pulse per Fig. 4 and derated above $T_A = 25^\circ\text{C}$ per Fig. 3.
- Mounted on copper pad area of $0.31 \times 0.31"$ ($8.0 \times 8.0\text{mm}$) to each terminal.
- Measured on 8.3ms single half sine wave or equivalent square wave for unidirectional device only, duty cycle=4 per minute maximum.

Functional Diagram

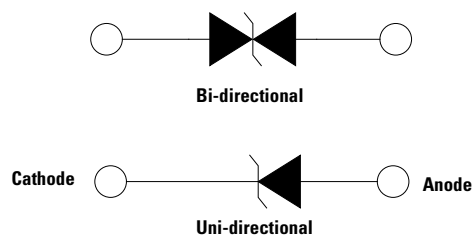

Description

The TPSMC series is designed specifically to protect sensitive electronic equipment from voltage transients induced by lightning and other transient voltage events.

Features

- High reliability application and automotive grade AEC-Q101 qualified
- For surface mounted applications to optimize board space
- Low profile package
- Typical failure mode is short from over-specified voltage or current
- Whisker test is conducted based on JEDEC JESD201A per its table 4a and 4c
- IEC 61000-4-2 ESD 30kV(Air), 30kV (Contact)
- ESD protection of data lines in accordance with IEC 61000-4-2
- EFT protection of data lines in accordance with IEC 61000-4-4
- Built-in strain relief
- $V_{BR} @ T_J = V_{BR} @ 25^\circ\text{C} \times (1 + \alpha T \times (T_J - 25))$ (α : Temperature Coefficient)
- Glass passivated chip junction
- 1500W peak pulse power capability at 10/1000 μs waveform, repetition rate (duty cycles):0.01%
- Fast response time: typically less than 1.0ps from 0V to V_{BR} min
- Excellent clamping capability
- Low incremental surge resistance
- Typical I_R less than $1\mu\text{A}$ above 13V
- High temperature soldering guaranteed: $260^\circ\text{C}/10$ seconds at terminals
- UL Recognized body that meets flammability rating V-0
- Meet MSL level1, per J-STD-020, high temperature soldering guaranteed.
- Matte tin lead-free plated
- Halogen free and RoHS compliant
- Pb-free E3 means 2nd level interconnect is Pb-free and the terminal finish material is tin(Sn) (IPC/JEDEC J-STD-609A.01)
- UL Recognized to ANSI/UL 497B: Protectors for Data Communications and Fire-Alarm Circuits

Applications

TVS Components are ideal for the protection of I/O Interfaces, V_{CC} bus and other vulnerable circuits used in Telecom, Computer, Industrial and Consumer electronic applications.

TPSMC Series

Surface Mount - 1500W

Electrical Characteristics

| Part Number (Uni) | Part Number (Bi) | Marking | | Reverse Stand off Voltage V_R (Volts) | Breakdown Voltage V_{BR} (Volts) @ I_T | | Test Current I_T (mA) | Maximum Clamping Voltage V_C @ I_{pp} (V) | Maximum Peak Pulse Current I_{pp} (A) | Maximum Reverse Leakage I_R @ V_R (μ A) | Agency Approval  |
|-------------------|------------------|---------|-------|---|--|--------|-------------------------|---|---|--|---|
| | | UNI | BI | | MIN | MAX | | | | | |
| TPSMC12A | TPSMC12CA | 12AA | 12CA | 10.20 | 11.40 | 12.60 | 1 | 16.7 | 91.0 | 5 | X |
| TPSMC13A | TPSMC13CA | 13AA | 13CA | 11.10 | 12.40 | 13.70 | 1 | 18.2 | 83.5 | 1 | X |
| TPSMC15A | TPSMC15CA | 15AA | 15CA | 12.80 | 14.30 | 15.80 | 1 | 21.2 | 71.7 | 1 | X |
| TPSMC16A | TPSMC16CA | 16AA | 16CA | 13.60 | 15.20 | 16.80 | 1 | 22.5 | 67.6 | 1 | X |
| TPSMC18A | TPSMC18CA | 18AA | 18CA | 15.30 | 17.10 | 18.90 | 1 | 25.2 | 60.3 | 1 | X |
| TPSMC20A | TPSMC20CA | 20AA | 20CA | 17.10 | 19.00 | 21.00 | 1 | 27.7 | 54.9 | 1 | X |
| TPSMC22A | TPSMC22CA | 22AA | 22CA | 18.80 | 20.90 | 23.10 | 1 | 30.6 | 49.7 | 1 | X |
| TPSMC24A | TPSMC24CA | 24AA | 24CA | 20.50 | 22.80 | 25.20 | 1 | 33.2 | 45.8 | 1 | X |
| TPSMC27A | TPSMC27CA | 27AA | 27CA | 23.10 | 25.70 | 28.40 | 1 | 37.5 | 40.5 | 1 | X |
| TPSMC30A | TPSMC30CA | 30AA | 30CA | 25.60 | 28.50 | 31.50 | 1 | 41.4 | 36.7 | 1 | X |
| TPSMC33A | TPSMC33CA | 33AA | 33CA | 28.20 | 31.40 | 34.70 | 1 | 45.7 | 33.3 | 1 | X |
| TPSMC36A | TPSMC36CA | 36AA | 36CA | 30.80 | 34.20 | 37.80 | 1 | 49.9 | 30.5 | 1 | X |
| TPSMC39A | TPSMC39CA | 39AA | 39CA | 33.30 | 37.10 | 41.00 | 1 | 53.9 | 28.2 | 1 | X |
| TPSMC43A | TPSMC43CA | 43AA | 43CA | 36.80 | 40.90 | 45.20 | 1 | 59.3 | 25.6 | 1 | X |
| TPSMC47A | TPSMC47CA | 47AA | 47CA | 40.20 | 44.70 | 49.40 | 1 | 64.8 | 23.5 | 1 | X |
| TPSMC51A | TPSMC51CA | 51AA | 51CA | 43.60 | 48.50 | 53.60 | 1 | 70.1 | 21.7 | 1 | X |
| TPSMC56A | TPSMC56CA | 56AA | 56CA | 47.80 | 53.20 | 58.80 | 1 | 77.0 | 19.7 | 1 | X |
| TPSMC62A | TPSMC62CA | 62AA | 62CA | 53.00 | 58.90 | 65.10 | 1 | 85.0 | 17.9 | 1 | X |
| TPSMC68A | TPSMC68CA | 68AA | 68CA | 58.10 | 64.60 | 71.40 | 1 | 92.0 | 16.5 | 1 | X |
| TPSMC75A | TPSMC75CA | 75AA | 75CA | 64.10 | 71.30 | 78.80 | 1 | 103.0 | 14.8 | 1 | X |
| TPSMC82A | TPSMC82CA | 82AA | 82CA | 70.10 | 77.90 | 86.10 | 1 | 113.0 | 13.5 | 1 | X |
| TPSMC91A | TPSMC91CA | 91AA | 91CA | 77.80 | 86.50 | 95.50 | 1 | 125.0 | 12.2 | 1 | X |
| TPSMC100A | TPSMC100CA | 100AA | 100CA | 85.50 | 95.00 | 105.26 | 1 | 137.0 | 11.1 | 1 | X |
| TPSMC110A | TPSMC110CA | 110AA | 110CA | 94.50 | 104.50 | 115.79 | 1 | 152.0 | 10 | 1 | X |
| TPSMC120A | TPSMC120CA | 120AA | 120CA | 102.60 | 114.00 | 126.32 | 1 | 165.0 | 9.2 | 1 | X |
| TPSMC130A | TPSMC130CA | 130AA | 130CA | 111.15 | 123.50 | 136.84 | 1 | 179.0 | 8.5 | 1 | X |
| TPSMC150A | TPSMC150CA | 150AA | 150CA | 128.25 | 142.50 | 157.89 | 1 | 207.0 | 7.3 | 1 | X |
| TPSMC160A | TPSMC160CA | 160AA | 160CA | 136.80 | 152.00 | 168.42 | 1 | 219.0 | 6.9 | 1 | X |
| TPSMC170A | TPSMC170CA | 170AA | 170CA | 145.35 | 161.50 | 178.95 | 1 | 234.0 | 6.5 | 1 | X |
| TPSMC180A | TPSMC180CA | 180AA | 180CA | 153.90 | 171.00 | 189.47 | 1 | 246.0 | 6.2 | 1 | X |
| TPSMC200A | TPSMC200CA | 200AA | 200CA | 171.00 | 190.00 | 210.53 | 1 | 274.0 | 5.5 | 1 | X |
| TPSMC220A | TPSMC220CA | 220AA | 220CA | 188.10 | 209.00 | 231.58 | 1 | 328.0 | 4.6 | 1 | X |
| TPSMC250A | TPSMC250CA | 250AA | 250CA | 213.75 | 237.50 | 263.16 | 1 | 344.0 | 4.4 | 1 | X |

For bidirectional type having V_R of 10 volts and less, the I_R limit is double.

I-V Curve Characteristics

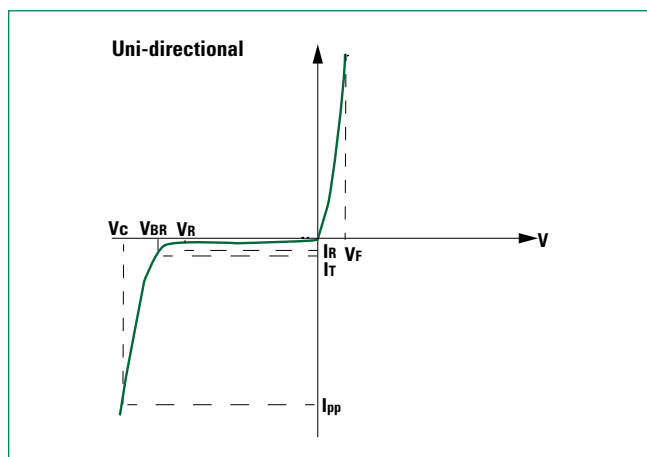

P_{ppm} **Peak Pulse Power Dissipation** -- Max power dissipation
 V_R **Stand-off Voltage** -- Maximum voltage that can be applied to the TVS without operation
 V_{BR} **Breakdown Voltage** -- Maximum voltage that flows though the TVS at a specified test current (I_T)

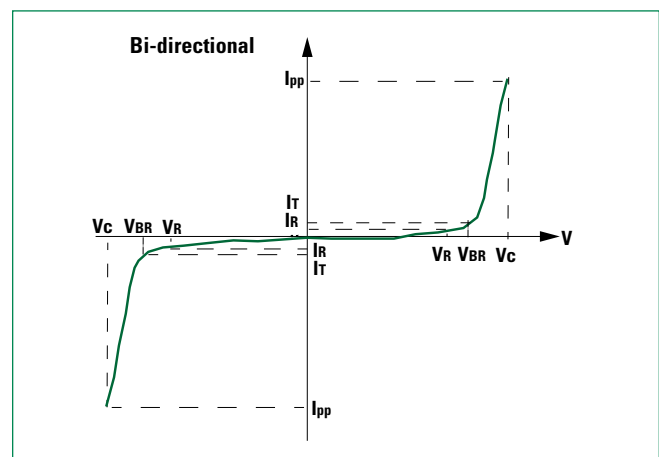

V_C **Clamping Voltage** -- Peak voltage measured across the TVS at a specified I_{ppm} (peak impulse current)
 I_R **Reverse Leakage Current** -- Current measured at V_R
 V_F **Forward Voltage Drop for Uni-directional**

TPSMC Series

Surface Mount - 1500W

Ratings and Characteristic Curves ($T_A=25^{\circ}\text{C}$ unless otherwise noted)

Figure 1 - TVS Transients Clamping Waveform

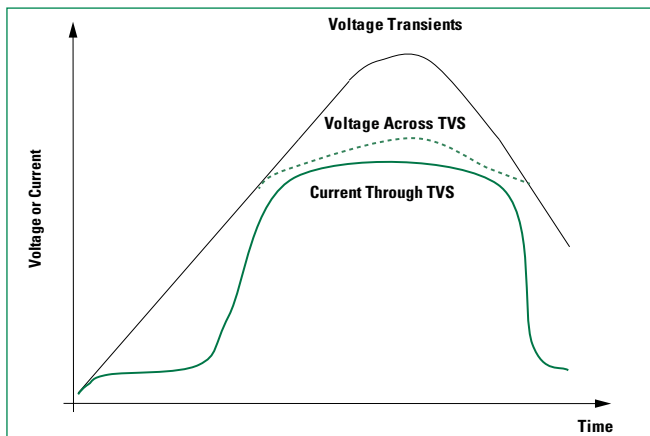

Figure 2 - Peak Pulse Power Rating

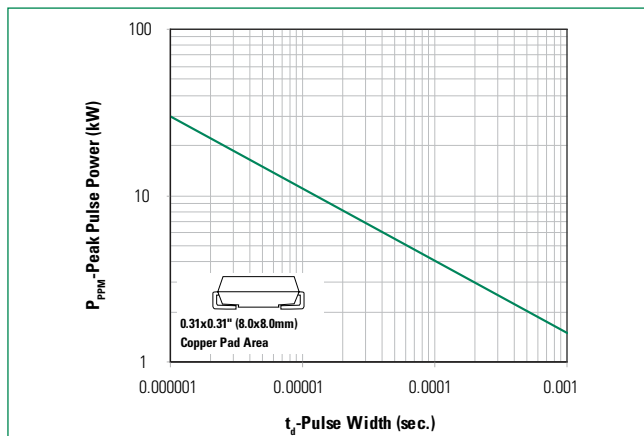

Figure 3 - Peak Pulse Power Derating Curve

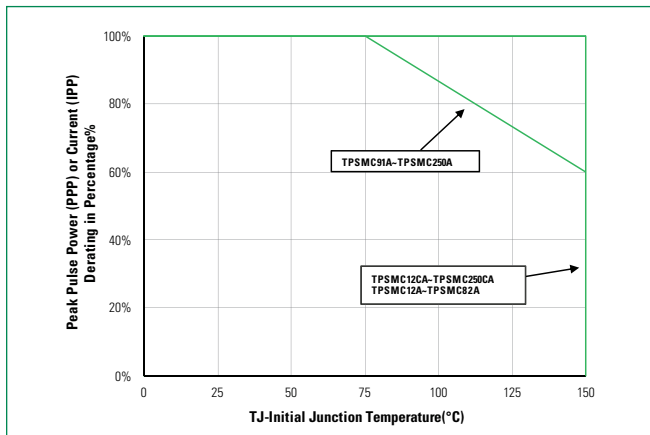

Figure 4 - Pulse Waveform

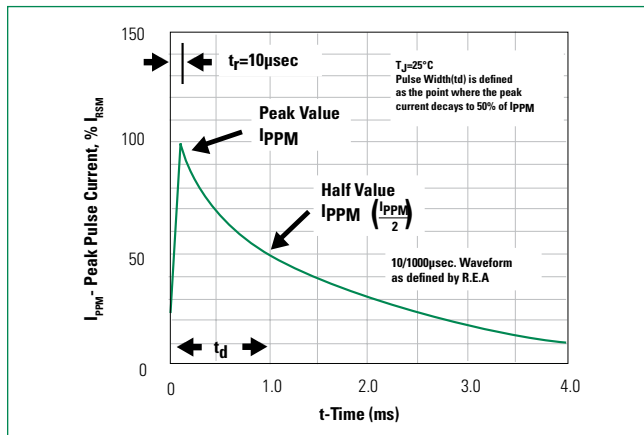

Figure 5 - Typical Junction Capacitance

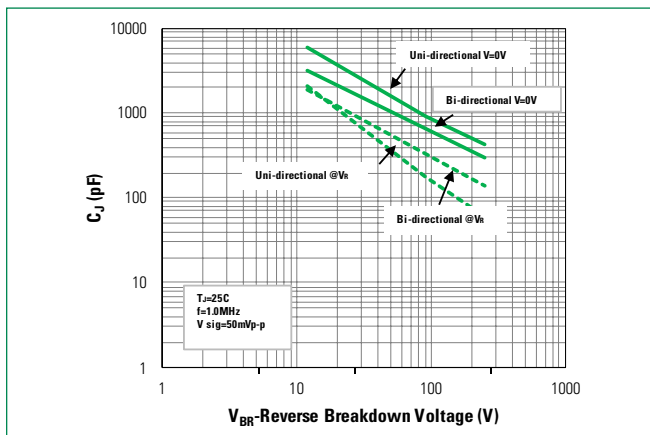
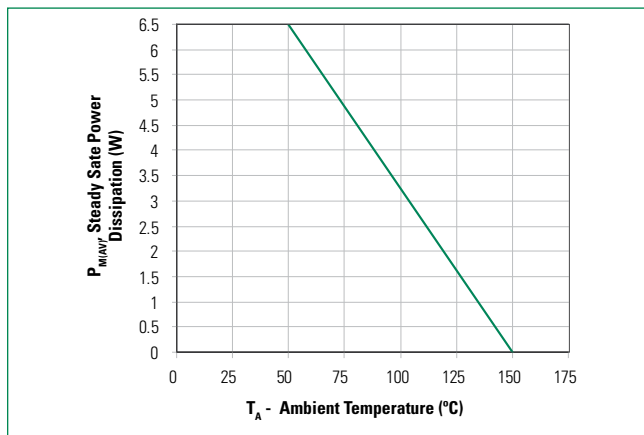

Figure 6 - Steady State Power Dissipation Derating Curve



TPSMC Series

Surface Mount - 1500W

Figure 7 - Maximum Non-Repetitive Peak Forward Surge Current Uni-Directional Only

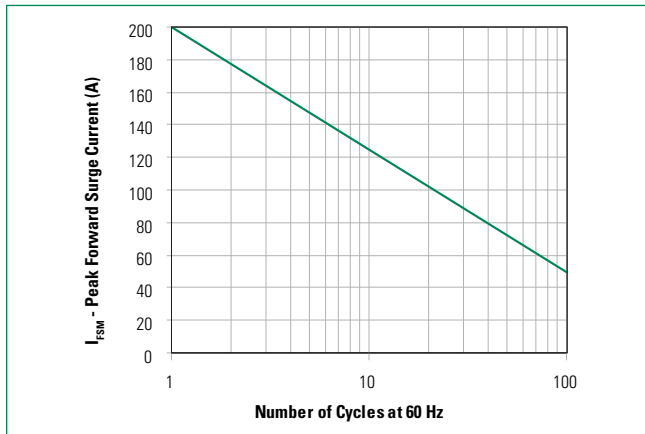

Physical Specifications

| | |
|-----------------|---|
| Weight | 0.007 ounce, 0.21 grams |
| Case | JEDEC DO214AB. Molded plastic body over glass passivated junction |
| Polarity | Color band denotes positive end (cathode) except Bidirectional. |
| Terminal | Matte Tin-plated leads, Solderable per JESD22-B102 |

Environmental Specifications

| | |
|----------------------------|--------------------------|
| High Temp. Storage | JESD22-A103 |
| HTRB | JESD22-A108 |
| Temperature Cycling | JESD22-A104 |
| MSL | JEDEC-J-STD-020, Level 1 |
| H3TRB | JESD22-A101 |
| RSH | JESD22-A111 |

Soldering Parameters

| | | |
|--|------------------------------------|-------------------------|
| Reflow Condition | Lead-free assembly | |
| Pre Heat | - Temperature Min ($T_{s(min)}$) | 150°C |
| | - Temperature Max ($T_{s(max)}$) | 200°C |
| | - Time (min to max) (t_s) | 60 – 120 secs |
| Average ramp up rate (Liquidus Temp (T_L) to peak) | | 3°C/second max |
| $T_{s(max)}$ to T_L - Ramp-up Rate | | 3°C/second max |
| Reflow | - Temperature (T_L) (Liquidus) | 217°C |
| | - Time (min to max) (t_r) | 60 – 150 seconds |
| Peak Temperature (T_p) | | 260 ^{+0/-5} °C |
| Time within 5°C of actual peak Temperature (t_p) | | 30 seconds max |
| Ramp-down Rate | | 6°C/second max |
| Time 25°C to peak Temperature (T_p) | | 8 minutes max. |
| Do not exceed | | 260°C |

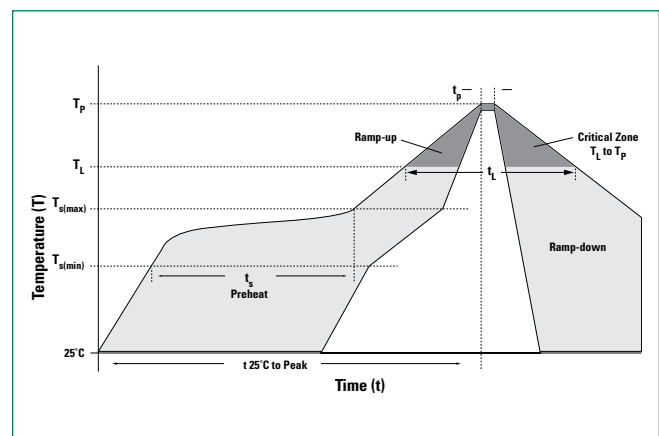

Dimensions

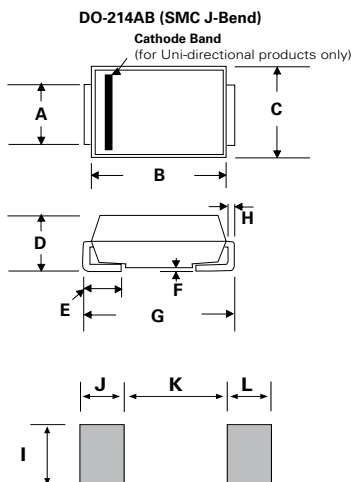

| Dimensions | Inches | | Millimeters | |
|------------|--------|-------|-------------|-------|
| | Min | Max | Min | Max |
| A | 0.114 | 0.126 | 2.900 | 3.200 |
| B | 0.260 | 0.280 | 6.600 | 7.110 |
| C | 0.220 | 0.245 | 5.590 | 6.220 |
| D | 0.079 | 0.103 | 2.060 | 2.620 |
| E | 0.030 | 0.060 | 0.760 | 1.520 |
| F | - | 0.008 | - | 0.203 |
| G | 0.305 | 0.320 | 7.750 | 8.130 |
| H | 0.006 | 0.012 | 0.152 | 0.305 |
| I | 0.129 | - | 3.300 | - |
| J | 0.094 | - | 2.400 | - |
| K | - | 0.165 | - | 4.200 |
| L | 0.094 | - | 2.400 | - |

TPSMC Series

Surface Mount - 1500W

Part Numbering System

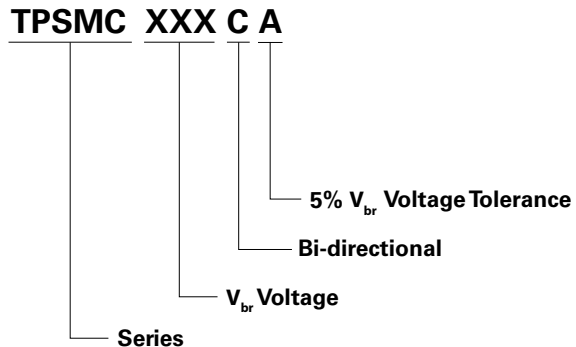

Part Marking System

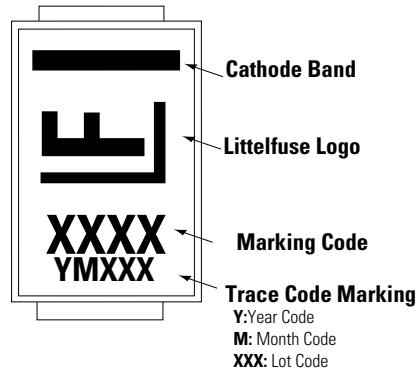

Packaging

| Part number | Component Package | Quantity | Packaging Option | Packaging Specification |
|-------------|-------------------|----------|----------------------------------|-------------------------|
| TPSMCxxxXX | DO-214AB | 3000 | Tape & Reel - 16mm tape/13" reel | EIA STD RS-481 |

Tape and Reel Specification

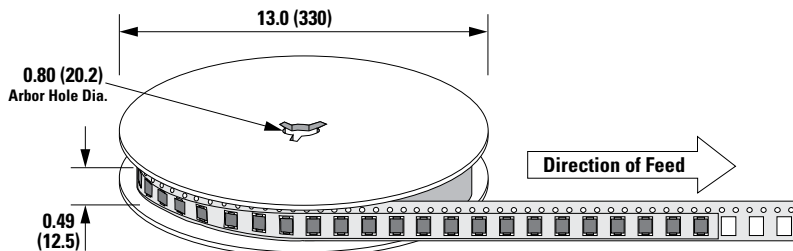
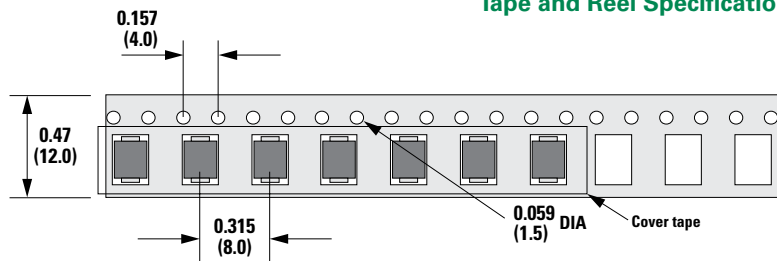

Cathode Mark For Unidirectional Components

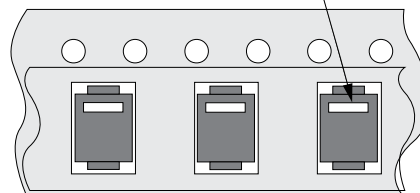

Disclaimer Notice - Information furnished is believed to be accurate and reliable. However, users should independently evaluate the suitability of and test each product selected for their own applications. Littelfuse products are not designed for, and may not be used in, all applications. Read complete Disclaimer Notice at <http://www.littelfuse.com/disclaimer-electronics>.

Looking for pricing, stock, or lifecycle information?

Click below to explore more details on WIN SOURCE:

 [View TPSMC33CA on WIN SOURCE](#)

 [Littelfuse Inc. Information](#)

Optimize Your Supply Chain with WIN SOURCE Solutions

-  Global Sourcing Solution
-  Obsolete Management
-  Cost Control Management
-  Shortage Management
-  Alternative Solution
-  Excess Inventory Management