

DATA SHEET

BFT92W

PNP 4 GHz wideband transistor

Product specification

May 1994



PNP 4 GHz wideband transistor

BFT92W

FEATURES

- High power gain
- Gold metallization ensures excellent reliability
- SOT323 (S-mini) package.

APPLICATION

It is intended as a general purpose transistor for wideband applications up to 2 GHz.

DESCRIPTION

Silicon PNP transistor in a plastic, SOT323 (S-mini) package. The BFT92W uses the same crystal as the SOT23 version, BFT92.

PINNING

PIN	DESCRIPTION
1	base
2	emitter
3	collector

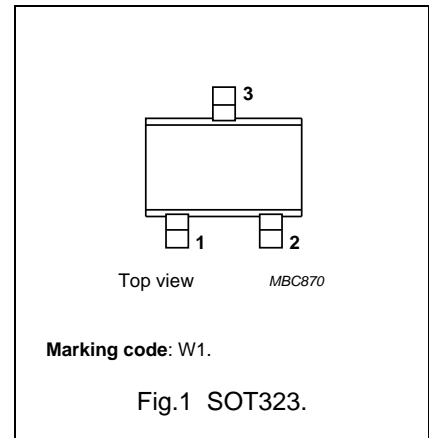

QUICK REFERENCE DATA

SYMBOL	PARAMETER	CONDITIONS	MIN.	TYP.	MAX.	UNIT
V_{CBO}	collector-base voltage	open emitter	–	–	–20	V
V_{CEO}	collector-emitter voltage	open base	–	–	–15	V
I_C	collector current (DC)		–	–	–35	mA
P_{tot}	total power dissipation	up to $T_s = 93\text{ °C}$; note 1	–	–	300	mW
h_{FE}	DC current gain	$I_C = -15\text{ mA}$; $V_{CE} = -10\text{ V}$	20	50	–	
C_{re}	feedback capacitance	$I_C = 0$; $V_{CB} = -10\text{ V}$; $f = 1\text{ MHz}$	–	0.5	–	pF
f_T	transition frequency	$I_C = -15\text{ mA}$; $V_{CE} = -10\text{ V}$; $f = 500\text{ MHz}$	–	4	–	GHz
G_{UM}	maximum unilateral power gain	$I_C = -15\text{ mA}$; $V_{CE} = -10\text{ V}$; $f = 500\text{ MHz}$; $T_{amb} = 25\text{ °C}$	–	17	–	dB
F	noise figure	$I_C = -5\text{ mA}$; $V_{CE} = -10\text{ V}$; $f = 500\text{ MHz}$	–	2.5	–	dB
T_j	junction temperature		–	–	150	°C

Note

1. T_s is the temperature at the soldering point of the collector pin.

PNP 4 GHz wideband transistor

BFT92W

LIMITING VALUES

In accordance with the Absolute Maximum Rating System (IEC 134).

SYMBOL	PARAMETER	CONDITIONS	MIN.	MAX.	UNIT
V _{CB0}	collector-base voltage	open emitter	–	–20	V
V _{CEO}	collector-emitter voltage	open base	–	–15	V
V _{EBO}	emitter-base voltage	open collector	–	–2	V
I _C	collector current (DC)		–	–25	mA
P _{tot}	total power dissipation	up to T _s = 93 °C; note 1	–	300	mW
T _{stg}	storage temperature		–65	+150	°C
T _j	junction temperature		–	150	°C

THERMAL CHARACTERISTICS

SYMBOL	PARAMETER	CONDITIONS	VALUE	UNIT
R _{th j-s}	thermal resistance from junction to soldering point	up to T _s = 93 °C; note 1	190	K/W

Note to the “Limiting values” and “Thermal characteristics”

1. T_s is the temperature at the soldering point of the collector pin.

CHARACTERISTICST_j = 25 °C (unless otherwise specified).

SYMBOL	PARAMETER	CONDITIONS	MIN.	TYP.	MAX.	UNIT
I _{CBO}	collector cut-off current	I _E = 0; V _{CB} = –10 V	–	–	–50	nA
h _{FE}	DC current gain	I _C = –15 mA; V _{CE} = –10 V	20	50	–	
f _T	transition frequency	I _C = –15 mA; V _{CE} = –10 V; f = 500 MHz; T _{amb} = 25 °C	–	4	–	GHz
C _c	collector capacitance	I _E = i _e = 0; V _{CB} = –10 V; f = 1 MHz	–	0.65	–	pF
C _e	emitter capacitance	I _C = i _c = 0; V _{EB} = –0.5 V; f = 1 MHz	–	0.75	–	pF
C _{re}	feedback capacitance	I _C = 0; V _{CB} = –10 V; f = 1 MHz	–	0.5	–	pF
G _{UM}	maximum unilateral power gain; note 1	I _C = –15 mA; V _{CE} = –10 V; f = 500 MHz; T _{amb} = 25 °C	–	17	–	dB
		I _C = –15 mA; V _{CE} = –10 V; f = 1 GHz; T _{amb} = 25 °C	–	11	–	dB
F	noise figure	Γ _s = Γ _{opt} ; I _C = –5 mA; V _{CE} = –10 V; f = 500 MHz	–	2.5	–	dB
		Γ _s = Γ _{opt} ; I _C = –5 mA; V _{CE} = –10 V; f = 1 GHz	–	3	–	dB

Note

1. G_{UM} is the maximum unilateral power gain, assuming s₁₂ is zero. $G_{UM} = 10 \log \frac{|s_{21}|^2}{(1 - |s_{11}|^2)(1 - |s_{22}|^2)}$ dB.

PNP 4 GHz wideband transistor

BFT92W

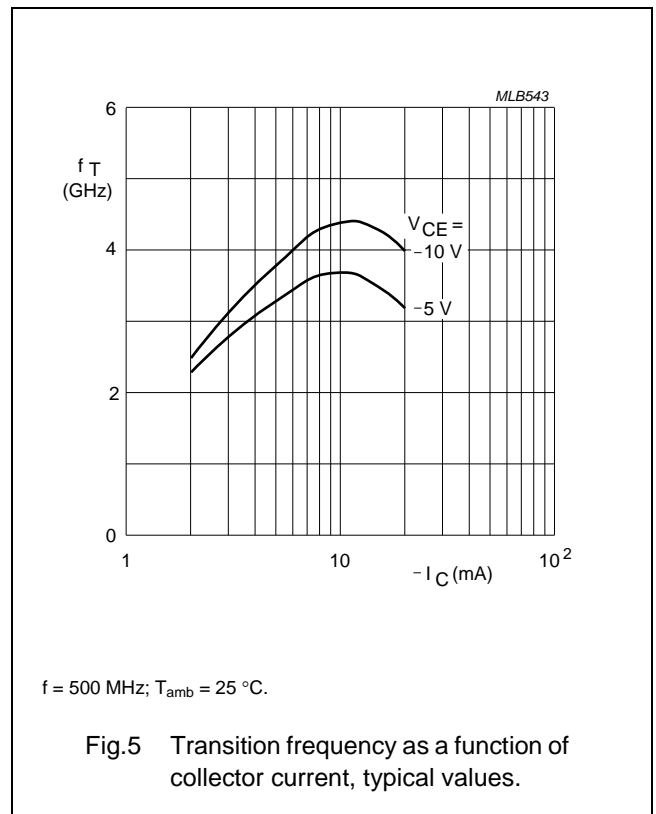
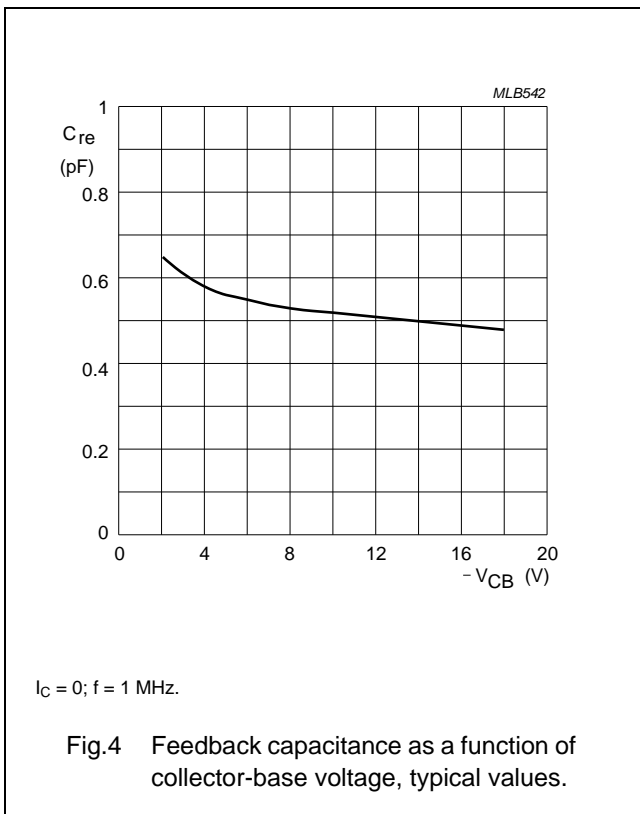
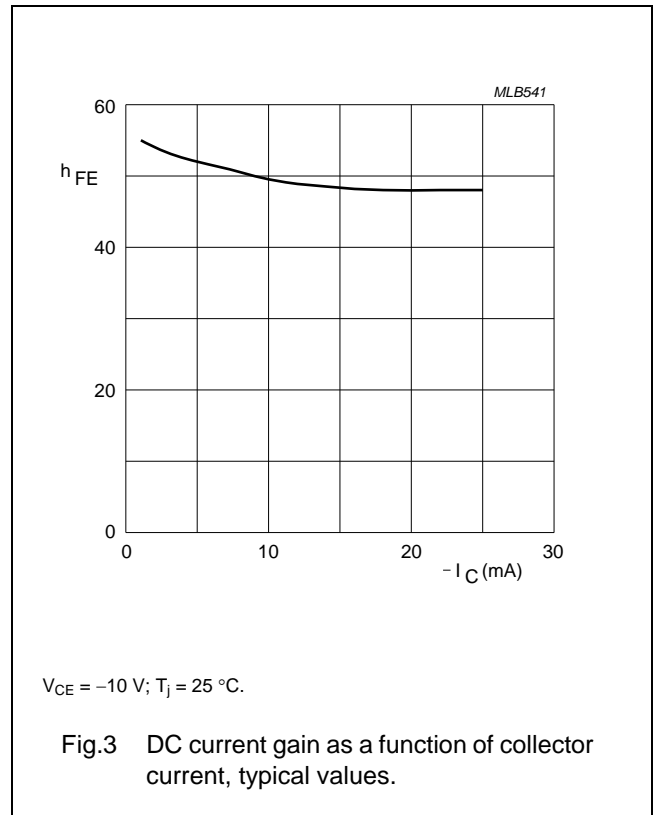
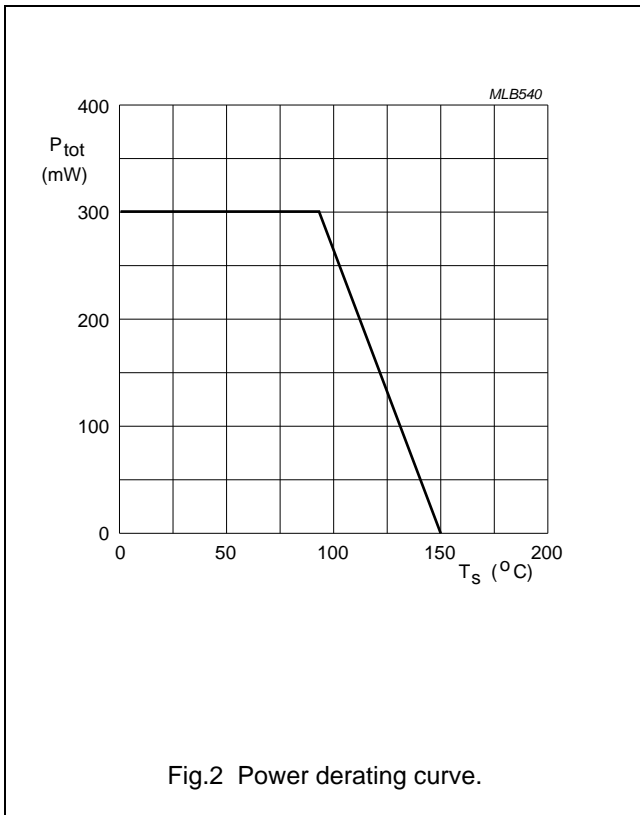

PNP 4 GHz wideband transistor

BFT92W

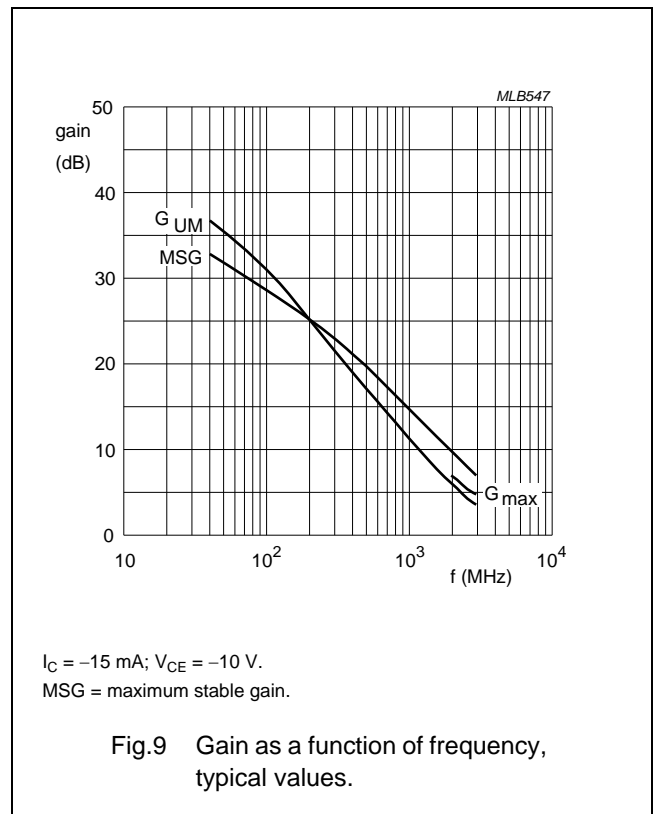
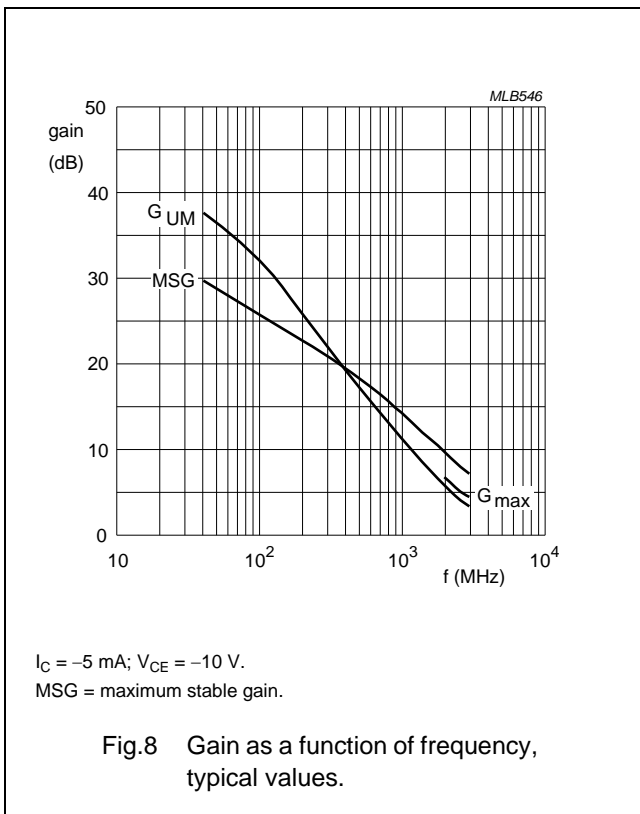
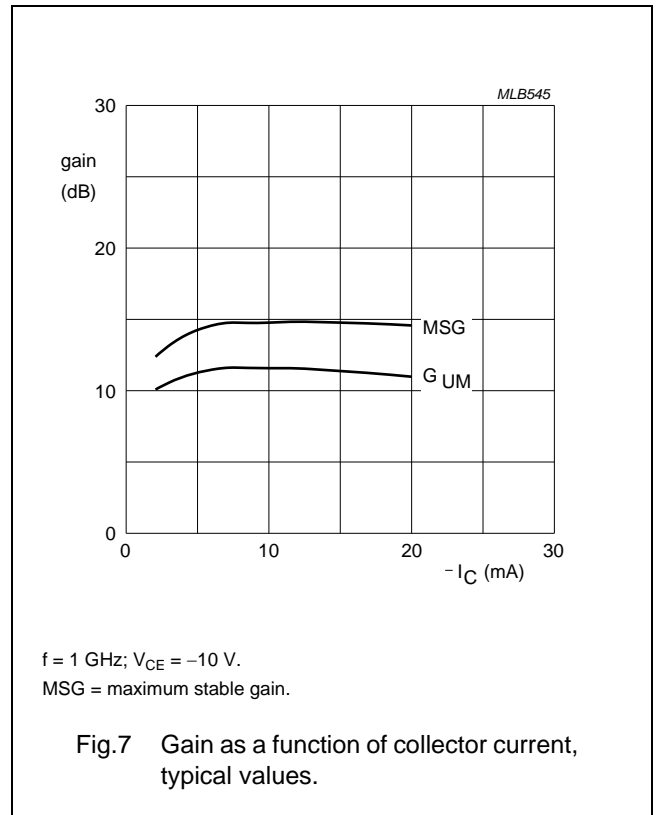
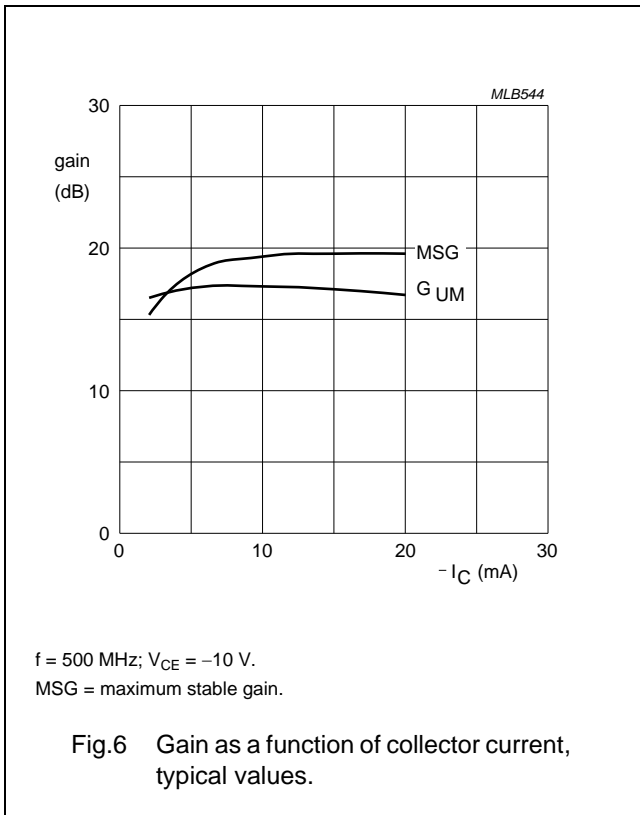

PNP 4 GHz wideband transistor

BFT92W

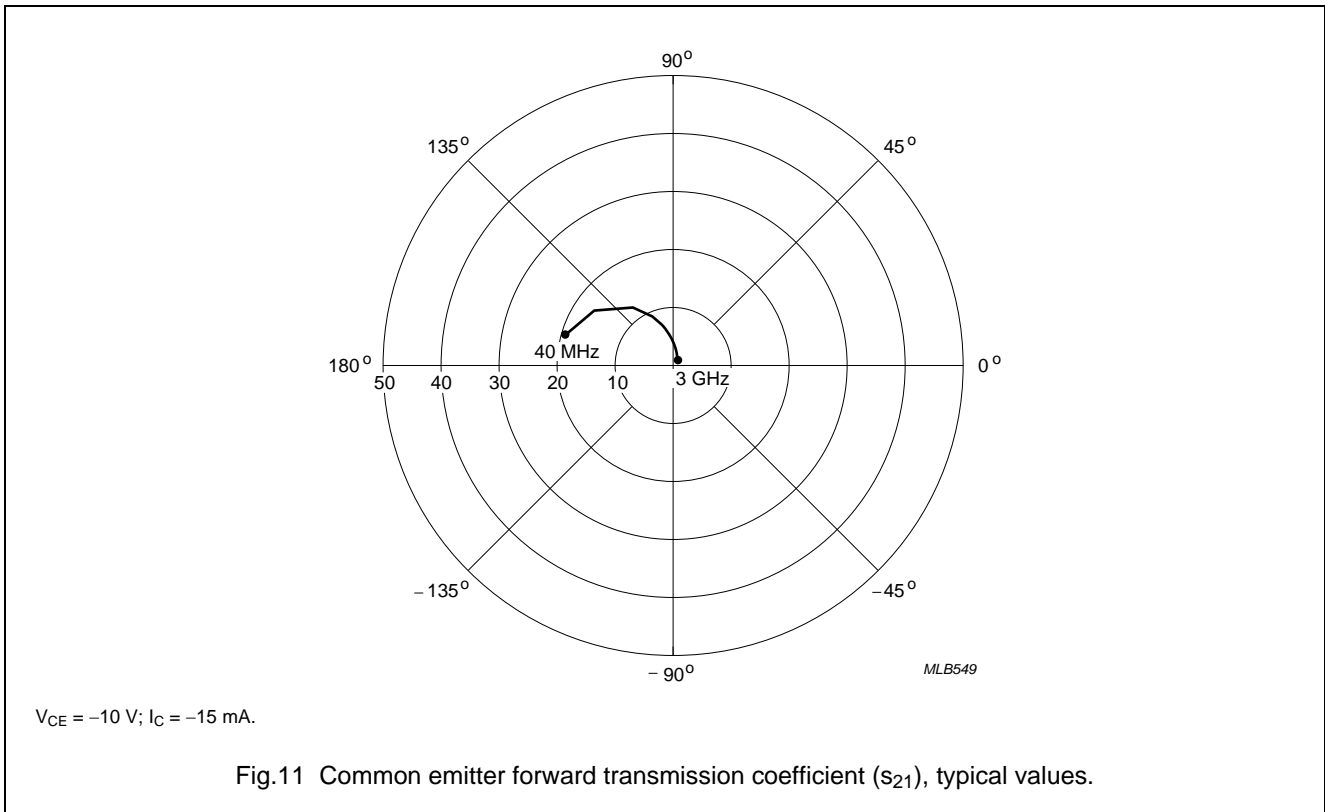
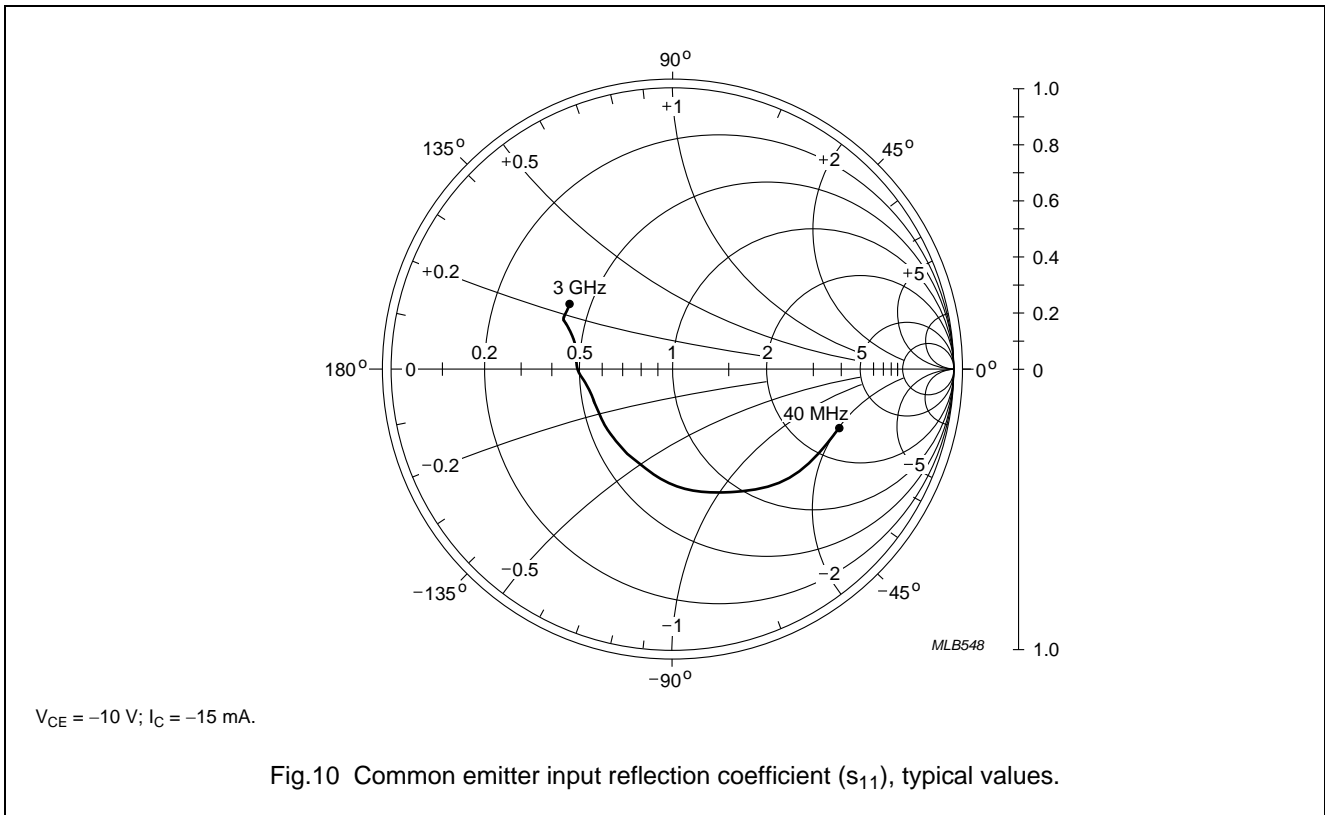

PNP 4 GHz wideband transistor

BFT92W

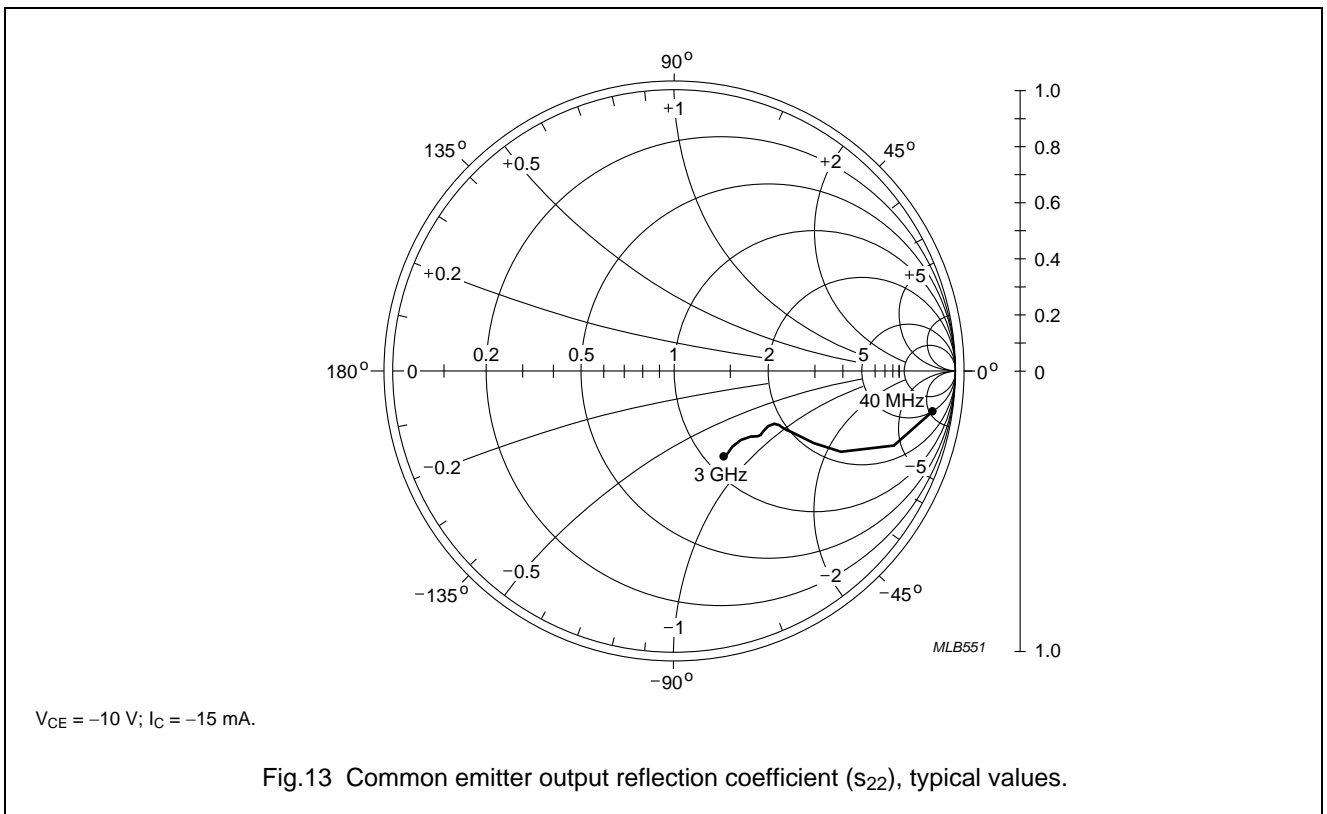
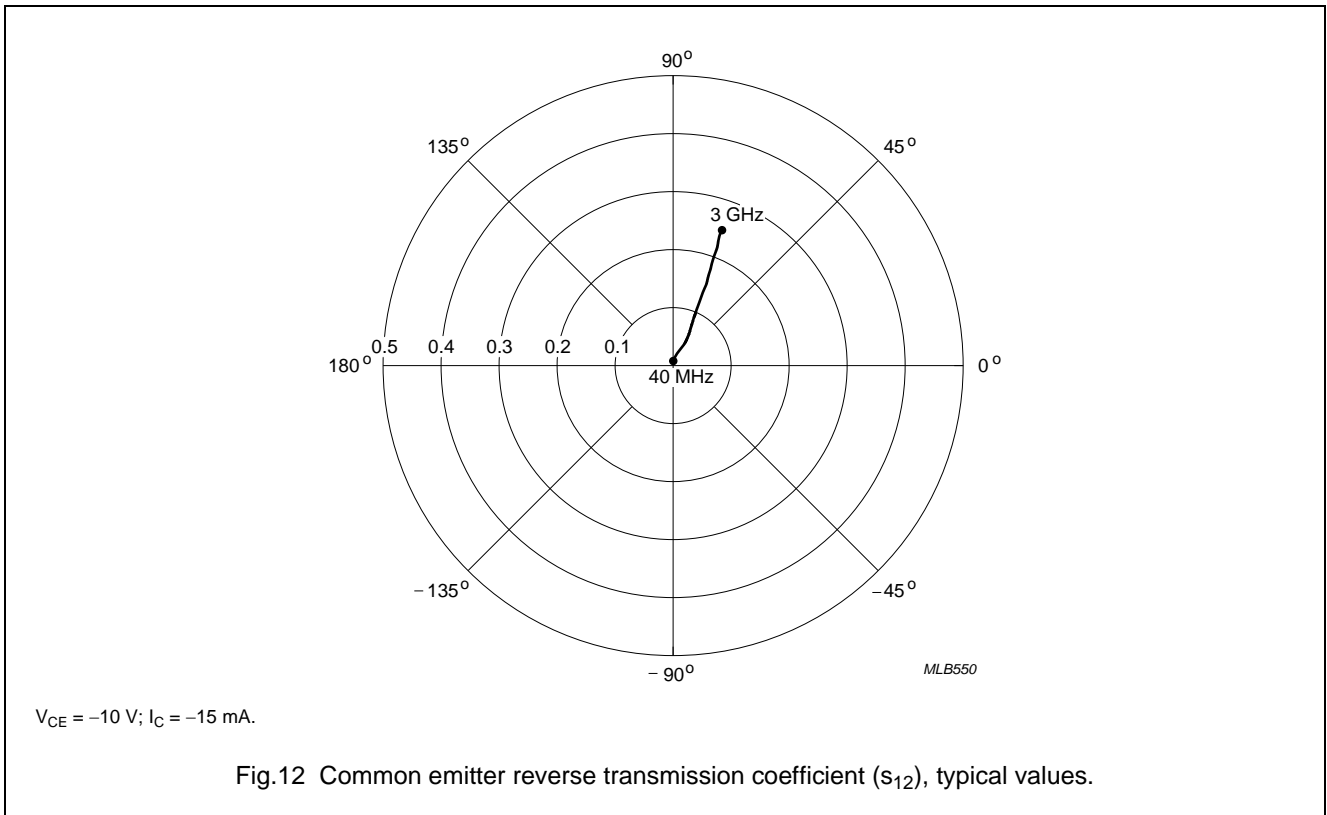

PNP 4 GHz wideband transistor

BFT92W

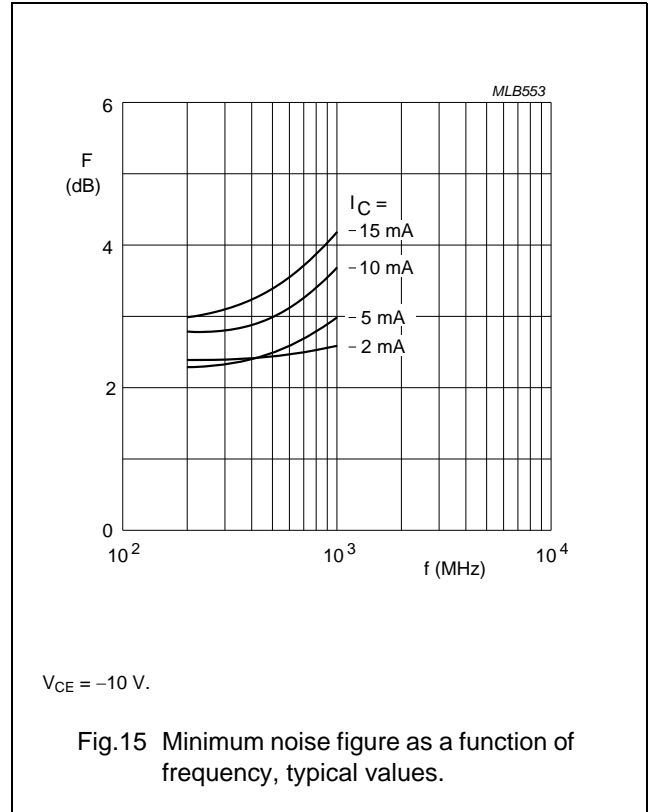
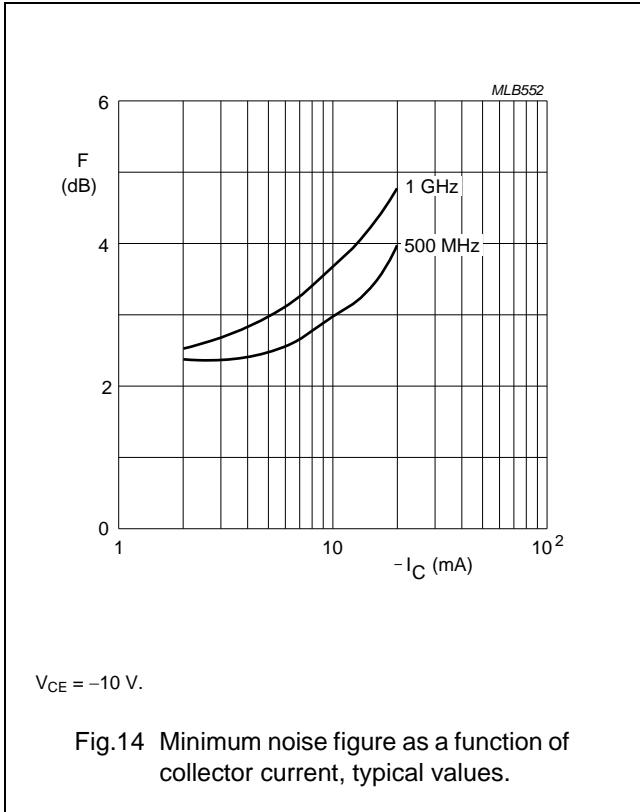

PNP 4 GHz wideband transistor

BFT92W

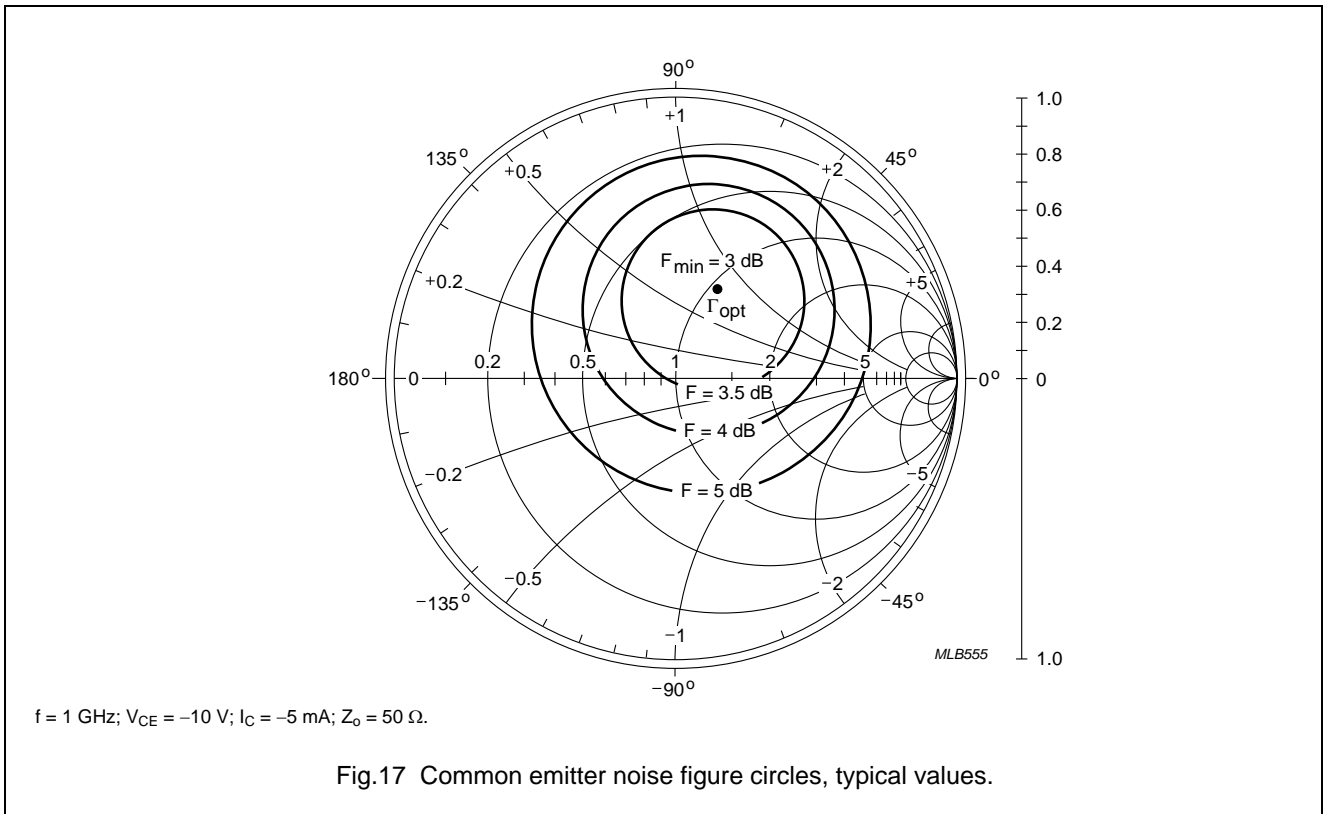
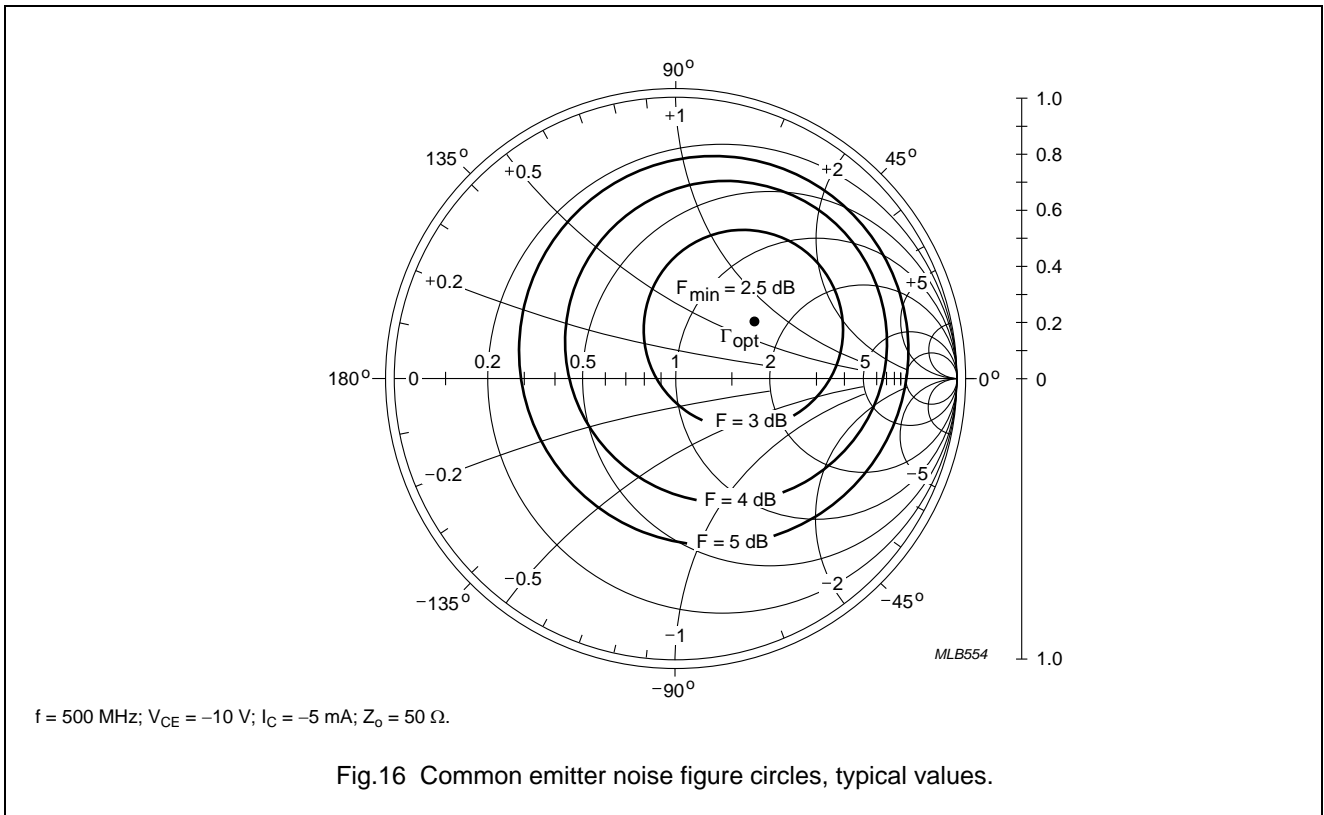

PNP 4 GHz wideband transistor

BFT92W

SPICE parameters for the BFT92W crystal

SEQUENCE No.	PARAMETER	VALUE	UNIT
1	IS	437.5	aA
2	BF	33.58	-
3	NF	1.009	-
4	VAF	23.39	V
5	IKF	99.53	mA
6	ISE	87.05	fA
7	NE	1.943	-
8	BR	4.947	-
9	NR	1.002	-
10	VAR	3.903	V
11	IKR	5.281	mA
12	ISC	35.88	fA
13	NC	1.393	-
14	RB	5.000	Ω
15	IRB	1.000	μ A
16	RBM	5.000	Ω
17	RE	1.000	Ω
18	RC	10.00	Ω
19 ⁽¹⁾	XTB	0.000	-
20 ⁽¹⁾	EG	1.110	eV
21 ⁽¹⁾	XTI	3.000	-
22	CJE	746.6	fF
23	VJE	600.0	mV
24	MJE	0.357	-
25	TF	17.49	ps
26	XTF	1.354	-
27	VTF	155.6	mV
28	ITF	1.000	mA
29	PTF	45.00	deg
30	CJC	937.1	fF
31	VJC	396.4	mV
32	MJC	0.200	-
33	XCJC	0.106	-
34	TR	8.422	ns
35 ⁽¹⁾	CJS	0.000	F

SEQUENCE No.	PARAMETER	VALUE	UNIT
36 ⁽¹⁾	VJS	750.0	mV
37 ⁽¹⁾	MJS	0.000	-
38	FC	0.768	-

Note

1. These parameters have not been extracted, the default values are shown.

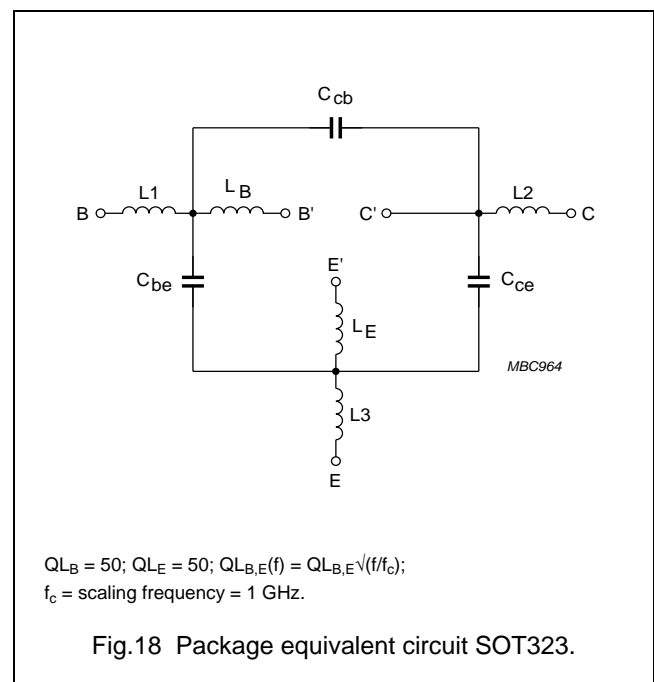

Fig.18 Package equivalent circuit SOT323.

List of components (see Fig.18)

DESIGNATION	VALUE	UNIT
C_{be}	2	fF
C_{cb}	100	fF
C_{ce}	100	fF
L1	0.34	nH
L2	0.10	nH
L3	0.34	nH
L_B	0.60	nH
L_E	0.60	nH

PNP 4 GHz wideband transistor

BFT92W

PACKAGE OUTLINE

Plastic surface-mounted package; 3 leads

SOT323

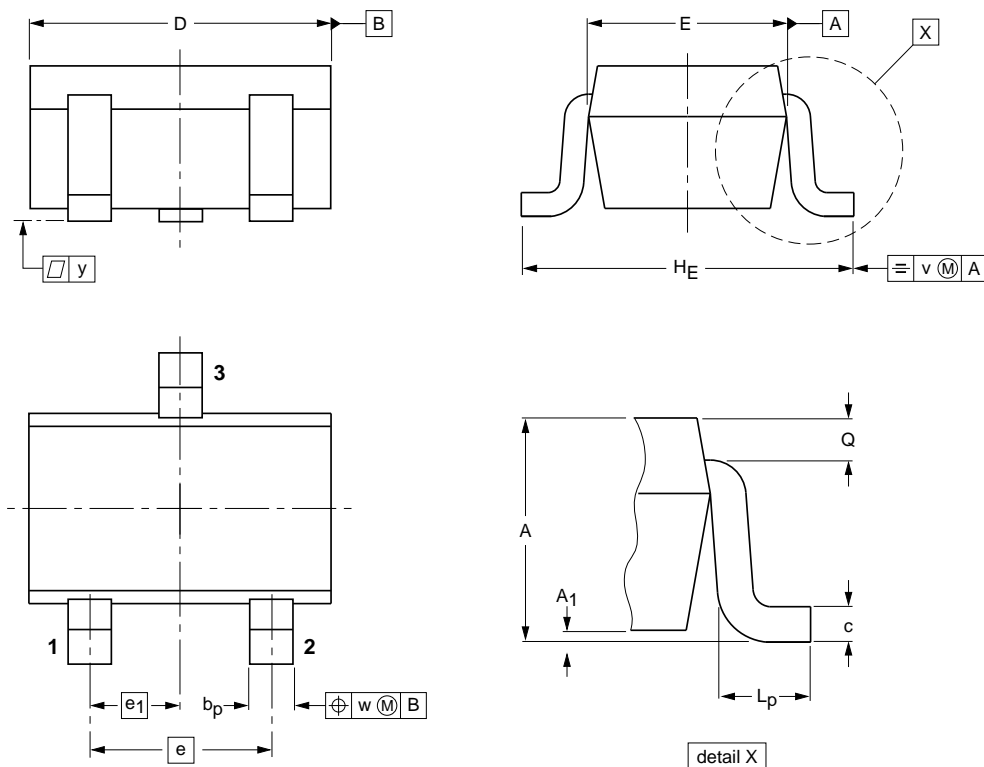

DIMENSIONS (mm are the original dimensions)

UNIT	A	A ₁ max	b _p	c	D	E	e	e ₁	H _E	L _p	Q	v	w
mm	1.1 0.8	0.1	0.4 0.3	0.25 0.10	2.2 1.8	1.35 1.15	1.3	0.65	2.2 2.0	0.45 0.15	0.23 0.13	0.2	0.2

OUTLINE VERSION	REFERENCES				EUROPEAN PROJECTION	ISSUE DATE
	IEC	JEDEC	JEITA			
SOT323			SC-70			04-11-04 06-03-16

PNP 4 GHz wideband transistor

BFT92W

DATA SHEET STATUS

DOCUMENT STATUS ⁽¹⁾	PRODUCT STATUS ⁽²⁾	DEFINITION
Objective data sheet	Development	This document contains data from the objective specification for product development.
Preliminary data sheet	Qualification	This document contains data from the preliminary specification.
Product data sheet	Production	This document contains the product specification.

Notes

1. Please consult the most recently issued document before initiating or completing a design.
2. The product status of device(s) described in this document may have changed since this document was published and may differ in case of multiple devices. The latest product status information is available on the Internet at URL <http://www.nxp.com>.

DEFINITIONS

Product specification — The information and data provided in a Product data sheet shall define the specification of the product as agreed between NXP Semiconductors and its customer, unless NXP Semiconductors and customer have explicitly agreed otherwise in writing. In no event however, shall an agreement be valid in which the NXP Semiconductors product is deemed to offer functions and qualities beyond those described in the Product data sheet.

DISCLAIMERS

Limited warranty and liability — Information in this document is believed to be accurate and reliable. However, NXP Semiconductors does not give any representations or warranties, expressed or implied, as to the accuracy or completeness of such information and shall have no liability for the consequences of use of such information.

In no event shall NXP Semiconductors be liable for any indirect, incidental, punitive, special or consequential damages (including - without limitation - lost profits, lost savings, business interruption, costs related to the removal or replacement of any products or rework charges) whether or not such damages are based on tort (including negligence), warranty, breach of contract or any other legal theory.

Notwithstanding any damages that customer might incur for any reason whatsoever, NXP Semiconductors' aggregate and cumulative liability towards customer for the products described herein shall be limited in accordance with the *Terms and conditions of commercial sale* of NXP Semiconductors.

Right to make changes — NXP Semiconductors reserves the right to make changes to information published in this document, including without limitation specifications and product descriptions, at any time and without notice. This document supersedes and replaces all information supplied prior to the publication hereof.

Suitability for use — NXP Semiconductors products are not designed, authorized or warranted to be suitable for use in life support, life-critical or safety-critical systems or equipment, nor in applications where failure or malfunction of an NXP Semiconductors product can reasonably be expected to result in personal injury, death or severe property or environmental damage. NXP Semiconductors accepts no liability for inclusion and/or use of NXP Semiconductors products in such equipment or applications and therefore such inclusion and/or use is at the customer's own risk.

Applications — Applications that are described herein for any of these products are for illustrative purposes only. NXP Semiconductors makes no representation or warranty that such applications will be suitable for the specified use without further testing or modification.

Customers are responsible for the design and operation of their applications and products using NXP Semiconductors products, and NXP Semiconductors accepts no liability for any assistance with applications or customer product design. It is customer's sole responsibility to determine whether the NXP Semiconductors product is suitable and fit for the customer's applications and products planned, as well as for the planned application and use of customer's third party customer(s). Customers should provide appropriate design and operating safeguards to minimize the risks associated with their applications and products.

PNP 4 GHz wideband transistor

BFT92W

NXP Semiconductors does not accept any liability related to any default, damage, costs or problem which is based on any weakness or default in the customer's applications or products, or the application or use by customer's third party customer(s). Customer is responsible for doing all necessary testing for the customer's applications and products using NXP Semiconductors products in order to avoid a default of the applications and the products or of the application or use by customer's third party customer(s). NXP does not accept any liability in this respect.

Limiting values — Stress above one or more limiting values (as defined in the Absolute Maximum Ratings System of IEC 60134) will cause permanent damage to the device. Limiting values are stress ratings only and (proper) operation of the device at these or any other conditions above those given in the Recommended operating conditions section (if present) or the Characteristics sections of this document is not warranted. Constant or repeated exposure to limiting values will permanently and irreversibly affect the quality and reliability of the device.

Terms and conditions of commercial sale — NXP Semiconductors products are sold subject to the general terms and conditions of commercial sale, as published at <http://www.nxp.com/profile/terms>, unless otherwise agreed in a valid written individual agreement. In case an individual agreement is concluded only the terms and conditions of the respective agreement shall apply. NXP Semiconductors hereby expressly objects to applying the customer's general terms and conditions with regard to the purchase of NXP Semiconductors products by customer.

No offer to sell or license — Nothing in this document may be interpreted or construed as an offer to sell products that is open for acceptance or the grant, conveyance or implication of any license under any copyrights, patents or other industrial or intellectual property rights.

Export control — This document as well as the item(s) described herein may be subject to export control regulations. Export might require a prior authorization from national authorities.

Quick reference data — The Quick reference data is an extract of the product data given in the Limiting values and Characteristics sections of this document, and as such is not complete, exhaustive or legally binding.

Non-automotive qualified products — Unless this data sheet expressly states that this specific NXP Semiconductors product is automotive qualified, the product is not suitable for automotive use. It is neither qualified nor tested in accordance with automotive testing or application requirements. NXP Semiconductors accepts no liability for inclusion and/or use of non-automotive qualified products in automotive equipment or applications.

In the event that customer uses the product for design-in and use in automotive applications to automotive specifications and standards, customer (a) shall use the product without NXP Semiconductors' warranty of the product for such automotive applications, use and specifications, and (b) whenever customer uses the product for automotive applications beyond NXP Semiconductors' specifications such use shall be solely at customer's own risk, and (c) customer fully indemnifies NXP Semiconductors for any liability, damages or failed product claims resulting from customer design and use of the product for automotive applications beyond NXP Semiconductors' standard warranty and NXP Semiconductors' product specifications.

NXP Semiconductors

provides High Performance Mixed Signal and Standard Product solutions that leverage its leading RF, Analog, Power Management, Interface, Security and Digital Processing expertise

Customer notification

This data sheet was changed to reflect the new company name NXP Semiconductors, including new legal definitions and disclaimers. No changes were made to the technical content, except for package outline drawings which were updated to the latest version.

Contact information

For additional information please visit: <http://www.nxp.com>

For sales offices addresses send e-mail to: salesaddresses@nxp.com



© NXP B.V. 2010

All rights are reserved. Reproduction in whole or in part is prohibited without the prior written consent of the copyright owner.

The information presented in this document does not form part of any quotation or contract, is believed to be accurate and reliable and may be changed without notice. No liability will be accepted by the publisher for any consequence of its use. Publication thereof does not convey nor imply any license under patent- or other industrial or intellectual property rights.

Looking for pricing, stock, or lifecycle information?

Click below to explore more details on WIN SOURCE:

-  [View BFT92W,115 on WIN SOURCE](#)
-  [NXP / Nexperia Information](#)

Optimize Your Supply Chain with WIN SOURCE Solutions

-  Global Sourcing Solution
-  Obsolete Management
-  Cost Control Management
-  Shortage Management
-  Alternative Solution
-  Excess Inventory Management