



**THE DATASHEET OF  
TLV62065EVM-719**



## TLV62065EVM-719

This user's guide describes the characteristics, operation, and use of the TLV62065 evaluation module (EVM). The TLV62065EVM-719 is a fully assembled and tested platform for evaluating the performance of the [TLV62065](#) 2.0-A step-down converter. This document includes schematic diagrams, printed circuit board (PCB) layout, bill of materials, and test data. Throughout this document, the abbreviations *EVM*, *TLV62065EVM*, and the term *evaluation module* are synonymous with the TLV62065EVM-719 unless otherwise noted.

### Contents

1	Introduction .....	2
2	TLV62065EVM Schematic .....	2
3	Connector and Test Point Descriptions .....	3
4	Test Configuration .....	4
5	TLV62065EVM Test Data .....	5
6	TLV62065EVM Assembly Drawings and Layout .....	12
7	Bill of Materials .....	17

### List of Figures

1	TLV62065EVM Schematic.....	2
2	Hardware Board Connection .....	4
3	TLV62065 Efficiency vs Load Current, PFM Mode .....	5
4	TLV62065 Efficiency vs Load Current.....	6
5	TLV62065 Start-up Into 2.2-Ω Load .....	6
6	TLV62065 Start-up With No Load .....	6
7	TLV62065 Shutdown Into 2.2-Ω Load.....	7
8	TLV62065 Shutdown With No Load .....	7
9	TLV62065 Output Voltage Ripple, PFM Mode .....	8
10	TLV62065 Output Voltage Ripple, PWM Mode .....	8
11	TLV62065 Input Voltage Ripple.....	9
12	TLV62065 Gain and Phase vs Frequency.....	9
13	TLV62065 Gain and Phase vs Frequency .....	10
14	TLV62065 Transient Response, PFM Mode.....	10
15	TLV62065 Transient Response, PWM Mode.....	11
16	TLV62065EVM Component Placement, Top View .....	12
17	TLV62065EVM Top-Side Copper, Top View .....	13
18	TLV62065EVM Internal Layer 1, X-Ray View From Top.....	14
19	TLV62065EVM Internal Layer 2, X-Ray View From Top.....	15
20	TLV62065EVM Bottom-Side Copper, Bottom View.....	16



## 3 Connector and Test Point Descriptions

### 3.1 Enable Jumpers/Switches: TLV62065EVM

#### 3.1.1 J1, VIN

This header is the positive connection to the input power supply. The power supply must be connected between J1 and J3 (GND). Twist the leads to the input supply, and keep them as short as possible. The input voltage must be between 2.9 V and 5.5 V.

#### 3.1.2 J2, S+/S-

J2 S+/S- are the sense connections for the input of the converter. Connect a voltmeter, or the sense connection of a power supply or oscilloscope, to this header.

#### 3.1.3 J3, GND

This header is the return connection to the input power supply. Connect the power supply between J3 and J1 (VIN). Twist the leads to the input supply, and keep them as short as possible. The input voltage must be between 2.9 V and 5.5 V.

#### 3.1.4 J4, VOUT

This header is the positive output of the step-down converter. The output voltage of the TLV62065 is adjustable with feedback resistors R1 and R2. On the EVM, the output voltage is set to 1.8 V by default.

---

**NOTE:** A feed-forward capacitor (C5) is required. Refer to the [TLV62065 data sheet \(SLVSAC4\)](#) for detailed information.

---

#### 3.1.5 J5, S+/S-

J5 S+/S- are the sense connections for the output of the converter. Connect a voltmeter, or the sense connection of an electronic load or oscilloscope, to this header.

#### 3.1.6 J6, GND

J6 is the return connection of the converter. A load can be connected between J6 and J4 (V<sub>OUT</sub>). The converter is capable of carrying a load current up to 2.0 A.

#### 3.1.7 JP1, EN

This jumper enables/disables the TLV62065 on the EVM. Shorting jumper JP1 between the center pin and *On* turns on the unit. Shorting the jumper between center pin and *Off* turns off the unit. A 1-M $\Omega$  pullup resistor is connected between VIN and EN. Removing jumper JP1 turns on the converter.

### 3.1.8 JP2, MODE

This jumper enables/disables the power-saving mode under light loads. Shorting jumper JP2 between the center pin and PWM disables the power-saving mode. If the power-save mode is disabled, the converter operates in forced PWM mode over the entire load current range. Shorting the jumper between the center pin and PFM enables the power-saving mode. The device operates in power-saving mode under light load conditions. See the TLV62065 data sheet ([SLVSAC4](#)) for a detailed description of this configuration. A 1-M $\Omega$  pulldown resistor is connected between GND and MODE. By removing JP2, the converter operates in power-saving mode under light-load conditions.

### 3.1.9 J7, VOUT (SMA)

This SMA connector is connected to the output voltage of the TLV62065. It can be used to easily analyze the noise spectrum of the output voltage with a spectrum analyzer. By default, J7 is not assembled on the EVM.

## 4 Test Configuration

### 4.1 Hardware Setup

Figure 2 illustrates a typical hardware test configuration.

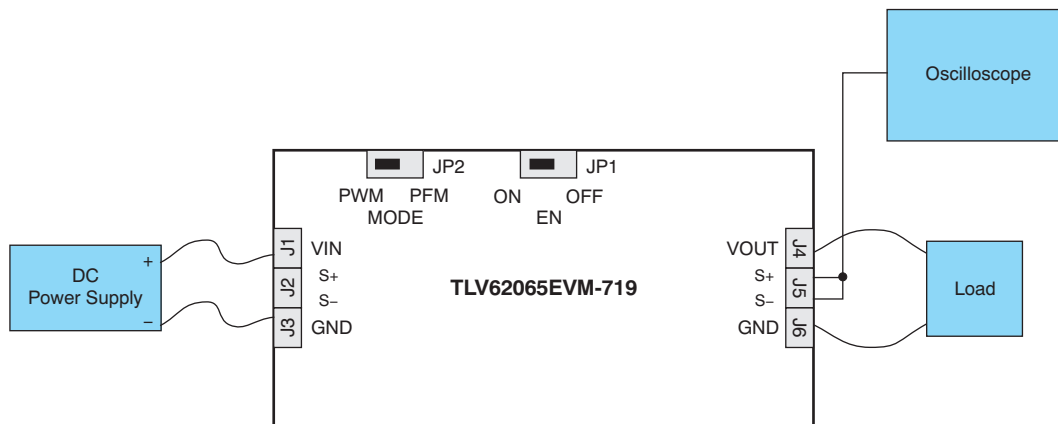

Figure 2. Hardware Board Connection

## 4.2 Testing Procedure

Follow these procedures when configuring the EVM for testing.

### CAUTION

Many of the components on the TLV62065EVM-719 are susceptible to damage by electrostatic discharge (ESD). Customers are advised to observe proper ESD-handling precautions when unpacking and handling the EVM, including the use of a grounded wrist strap, bootstraps, or mats at an approved ESD workstation. An electrostatic smock and safety glasses also are recommended.

1. Connect a dc power supply between J1 and J3 on the TLV62065EVM. Note that the input voltage must be between 2.9 V and 5.5 V. Keep the wires from the input power supply to the EVM as short as possible and twisted.
2. Connect a dc voltmeter or oscilloscope to J5, the output sense connection of the EVM.
3. A load can be connected between J4 and J6 on the TLV62065EVM.
4. To enable the converter, connect the shorting bar on JP1 between EN and ON located on the TLV62065EVM.
5. The TLV62065EVM has a feature to allow the user to switch between Power-Save mode under light loads and forced PWM mode; this feature is enabled or disabled with jumper JP2.

## 5 TLV62065EVM Test Data

Figure 3 through Figure 15 present typical performance curves for the TLV62065EVM. Actual performance data can be affected by measurement techniques and environmental variables; therefore, these curves are presented for reference and may differ from actual results obtained by some users.

### 5.1 Efficiency

Figure 3 and Figure 4 show the typical efficiency performance for the TLV62065EVM.

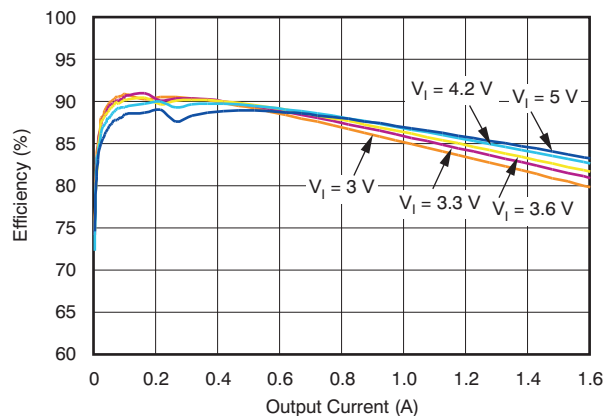

Figure 3. TLV62065 Efficiency vs Load Current, PFM Mode

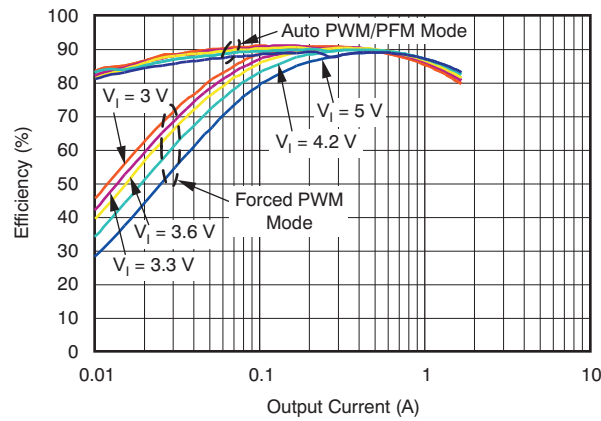
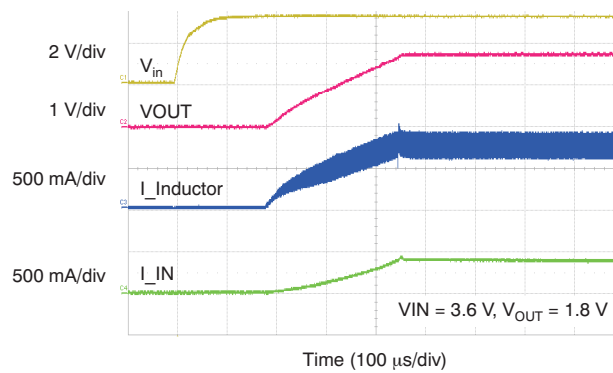

Figure 4. TLV62065 Efficiency vs Load Current

## 5.2 Start-up

Figure 5 and Figure 6 show the typical start-up performance for the TLV62065EVM.



Conditions:  $V_{IN} = 3.6\text{ V}$ ,  $V_{OUT} = 1.8\text{ V}$

Figure 5. TLV62065 Start-up Into 2.2-Ω Load

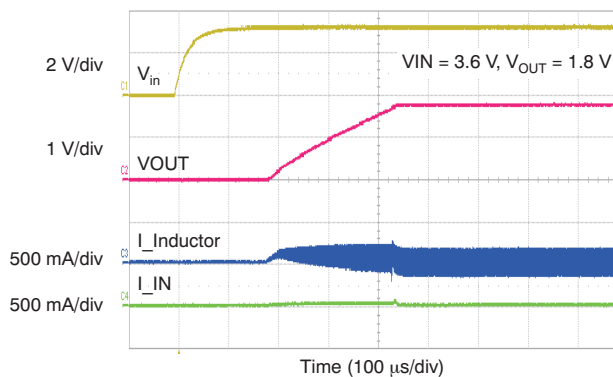
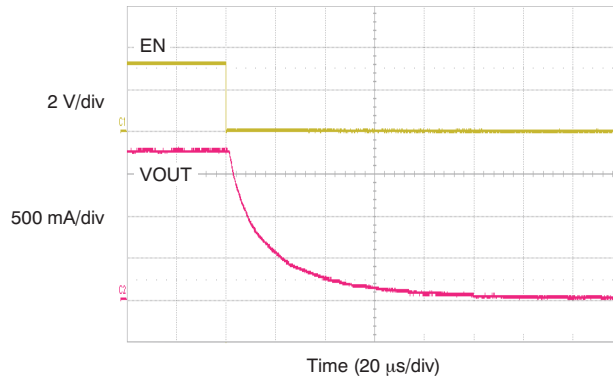

Figure 6. TLV62065 Start-up With No Load

### 5.3 Shutdown

Figure 7 and Figure 8 illustrate the typical shutdown behavior for the TLV62065EVM.



Conditions:  $V_{IN} = 3.6\text{ V}$ ,  $V_{OUT} = 1.8\text{ V}$

**Figure 7. TLV62065 Shutdown Into 2.2-Ω Load**

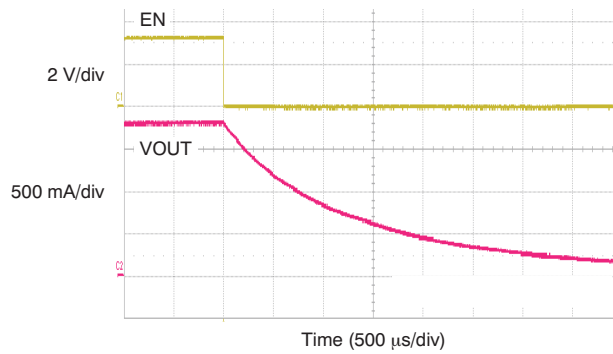

Conditions:  $V_{IN} = 3.6\text{ V}$ ,  $V_{OUT} = 1.8\text{ V}$

**Figure 8. TLV62065 Shutdown With No Load**

## 5.4 Output Voltage Ripple

Figure 9 and Figure 10 show the typical output voltage ripple for the TLV62065EVM in PFM and PWM modes, respectively.

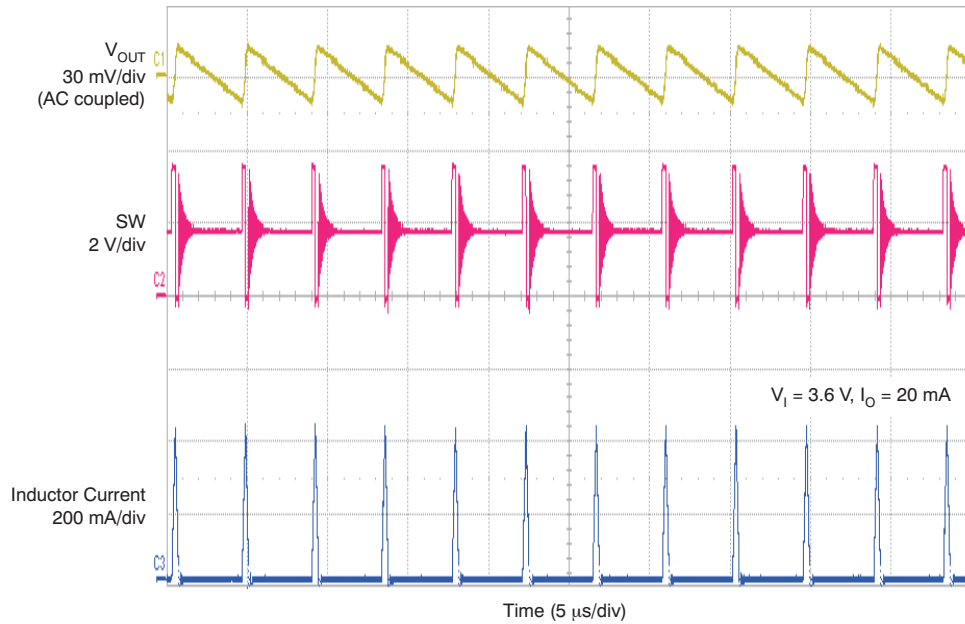

**Figure 9. TLV62065 Output Voltage Ripple, PFM Mode**

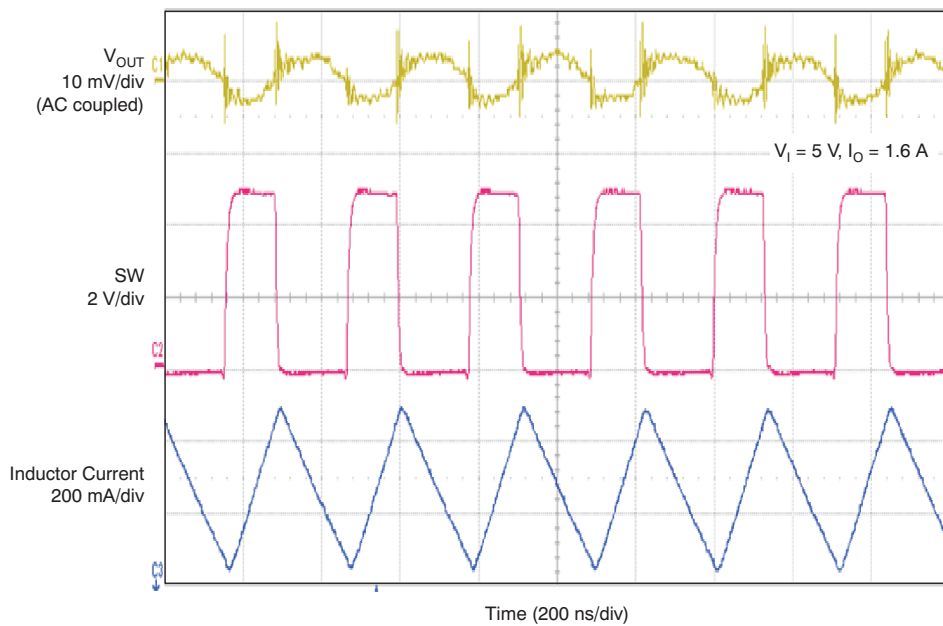

**Figure 10. TLV62065 Output Voltage Ripple, PWM Mode**

### 5.5 Input Voltage Ripple

Figure 11 shows the typical input voltage ripple for the TLV62065EVM at 3.6 V in and 1.6 A load.

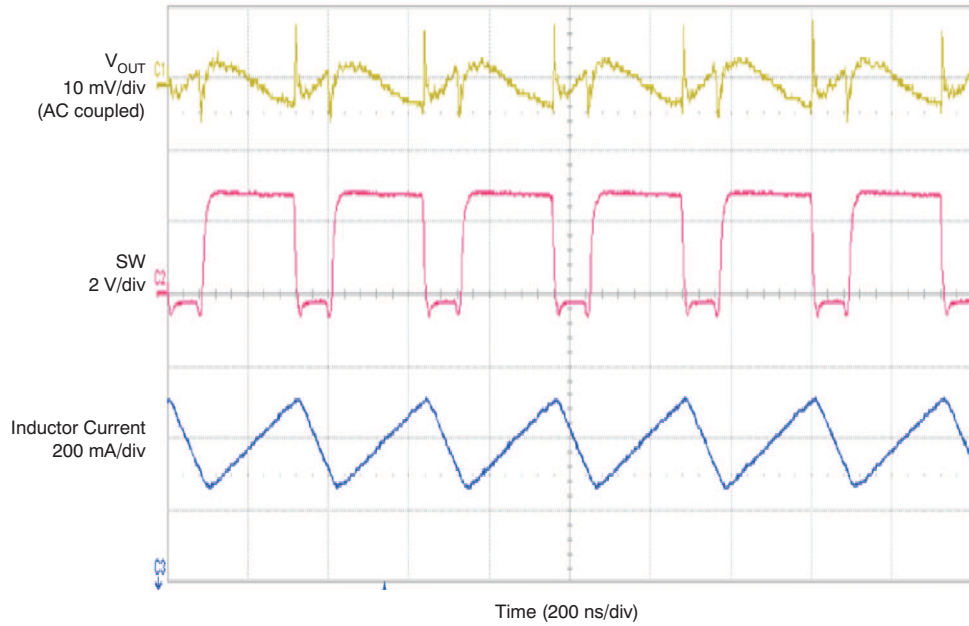
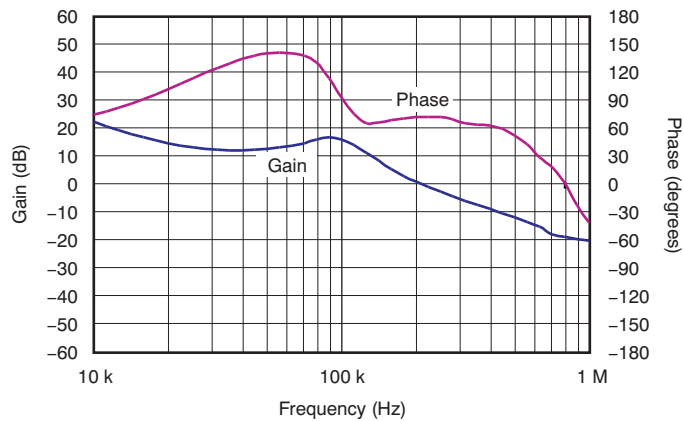

Figure 11. TLV62065 Input Voltage Ripple

### 5.6 Control Loop Bode Diagrams

Figure 12 and Figure 13 illustrate typical TLV62065EVM gain and phase performance versus frequency at  $V_{IN} = 3.6$  V and 5 V, respectively.



Conditions:  $V_{IN} = 3.6$  V,  $V_{OUT} = 1.8$  V,  $I_{OUT} = 1.6$  A; bandwidth: 213 kHz, phase margin: 73°

Figure 12. TLV62065 Gain and Phase vs Frequency

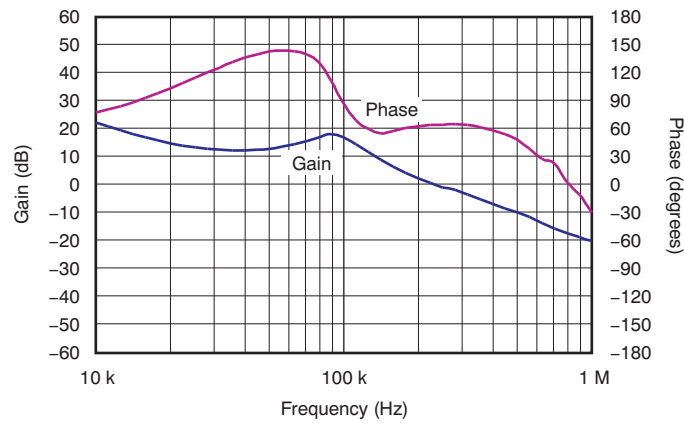

Conditions:  $V_{IN} = 5\text{ V}$ ,  $V_{OUT} = 1.8\text{ V}$ ,  $I_{OUT} = 1.6\text{ A}$ ; bandwidth: 241 kHz, phase margin:  $66^\circ$

**Figure 13. TLV62065 Gain and Phase vs Frequency**

### 5.7 Transient Performance

Figure 14 and Figure 15 show the load transient response of the TLV62065EVM in PFM and PWM modes, respectively.

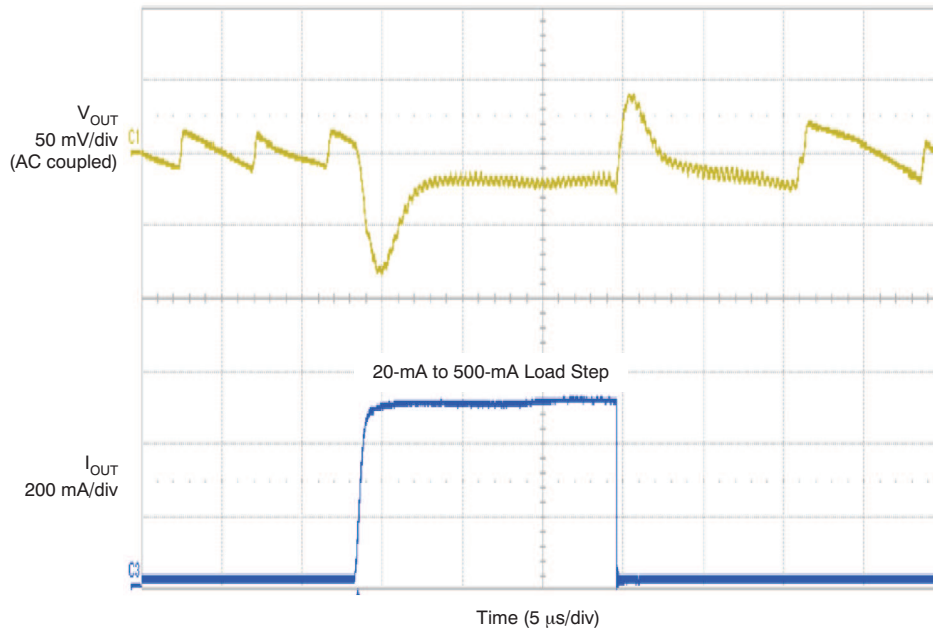

**Figure 14. TLV62065 Transient Response, PFM Mode**

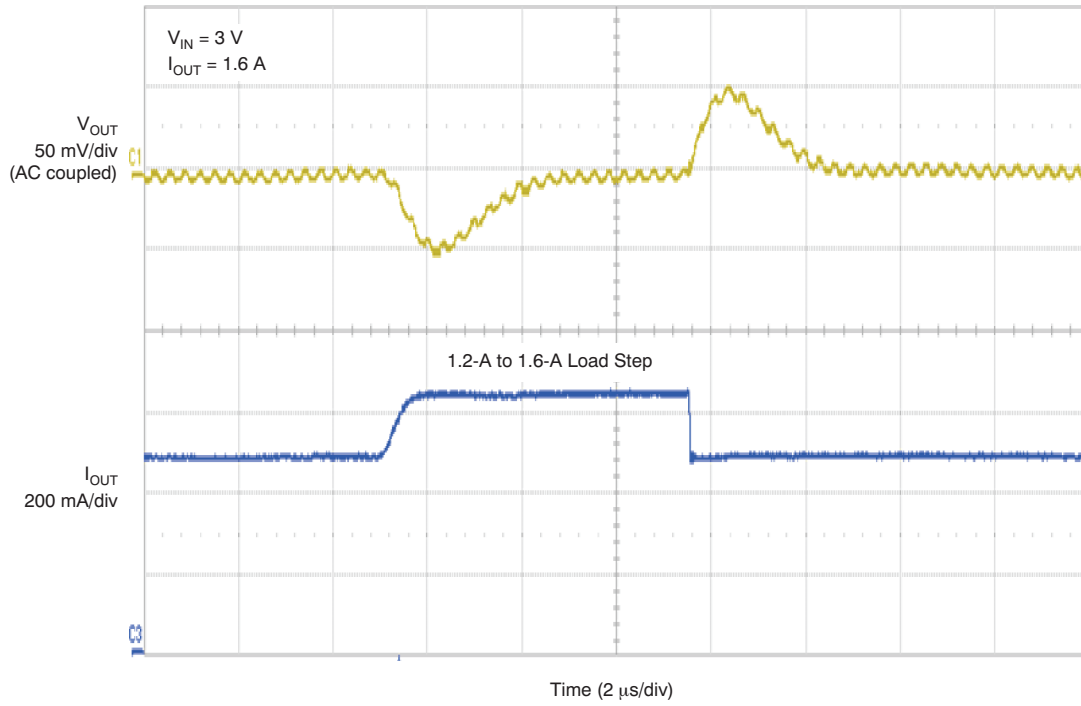

Figure 15. TLV62065 Transient Response, PWM Mode

## 6 TLV62065EVM Assembly Drawings and Layout

Figure 16 through Figure 20 show the design of the TLV62065EVM-719 printed circuit board. This EVM has been designed using a four-layer, 1-ounce, copper-clad PCB (1.8 in × 1.5 in, or 4.57 cm × 3.81 cm) with all components in an active area on the top side of the board. All active traces are routed on the top and bottom layers to allow the user to easily view, probe, and evaluate the TLV62065 device in a practical, double-sided application environment. Moving components to both sides of the PCB or using additional internal layers can offer additional size reduction for space-constrained systems.

**NOTE:** Board layouts are not to scale. These figures are intended to show how the board is laid out; they are not intended to be used for manufacturing TLV62065EVM-719 PCBs.

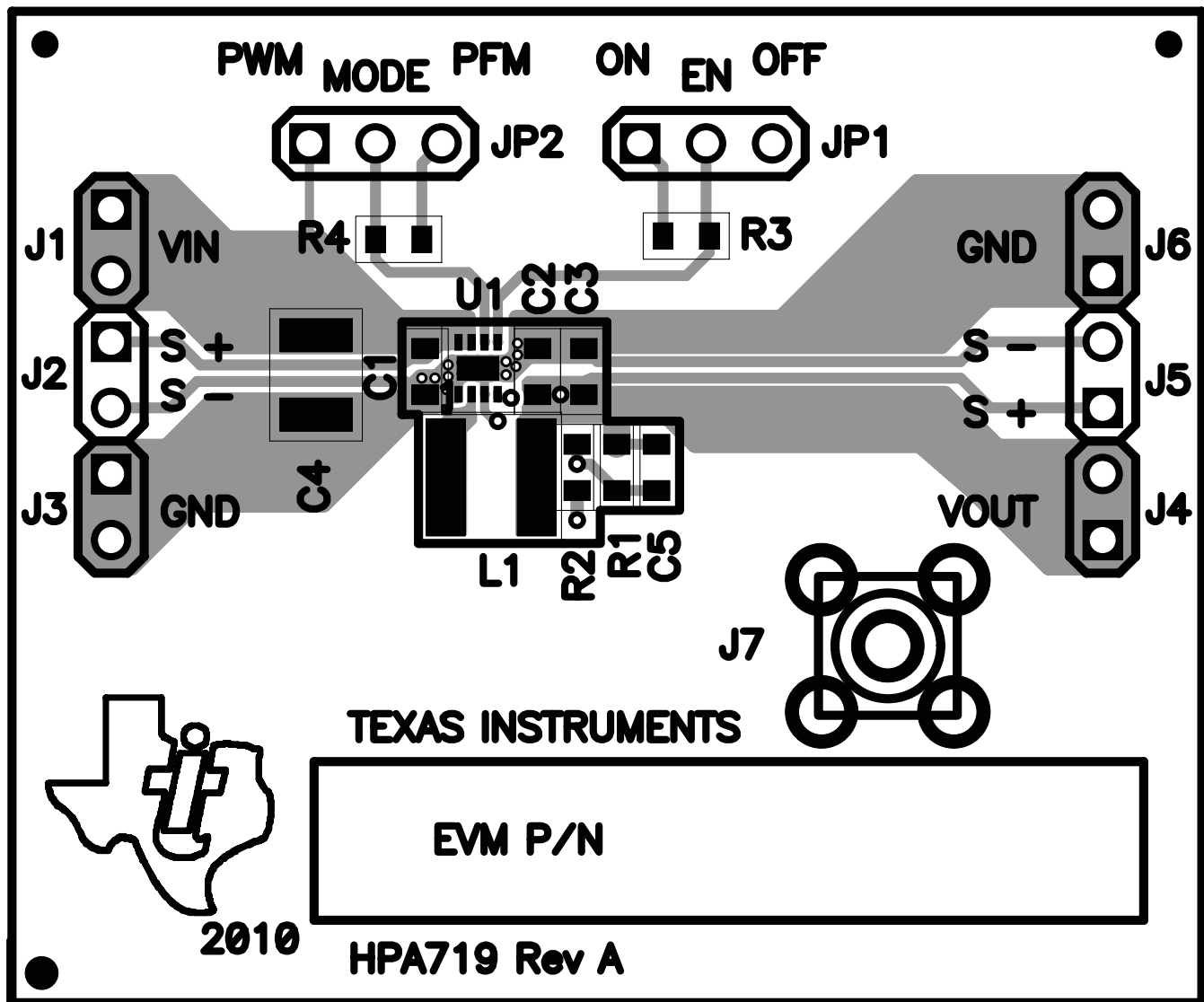

Figure 16. TLV62065EVM Component Placement, Top View

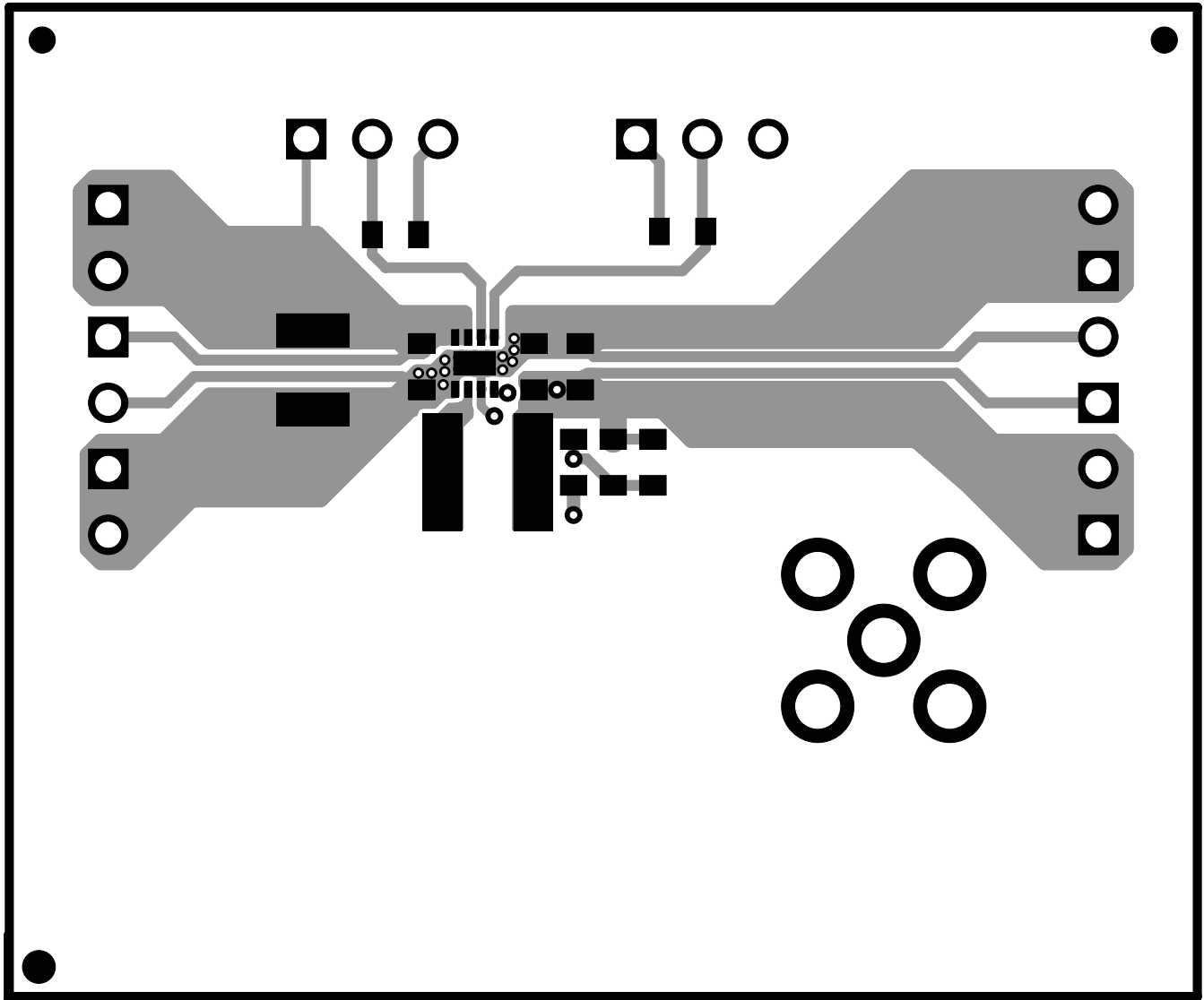

Figure 17. TLV62065EVM Top-Side Copper, Top View

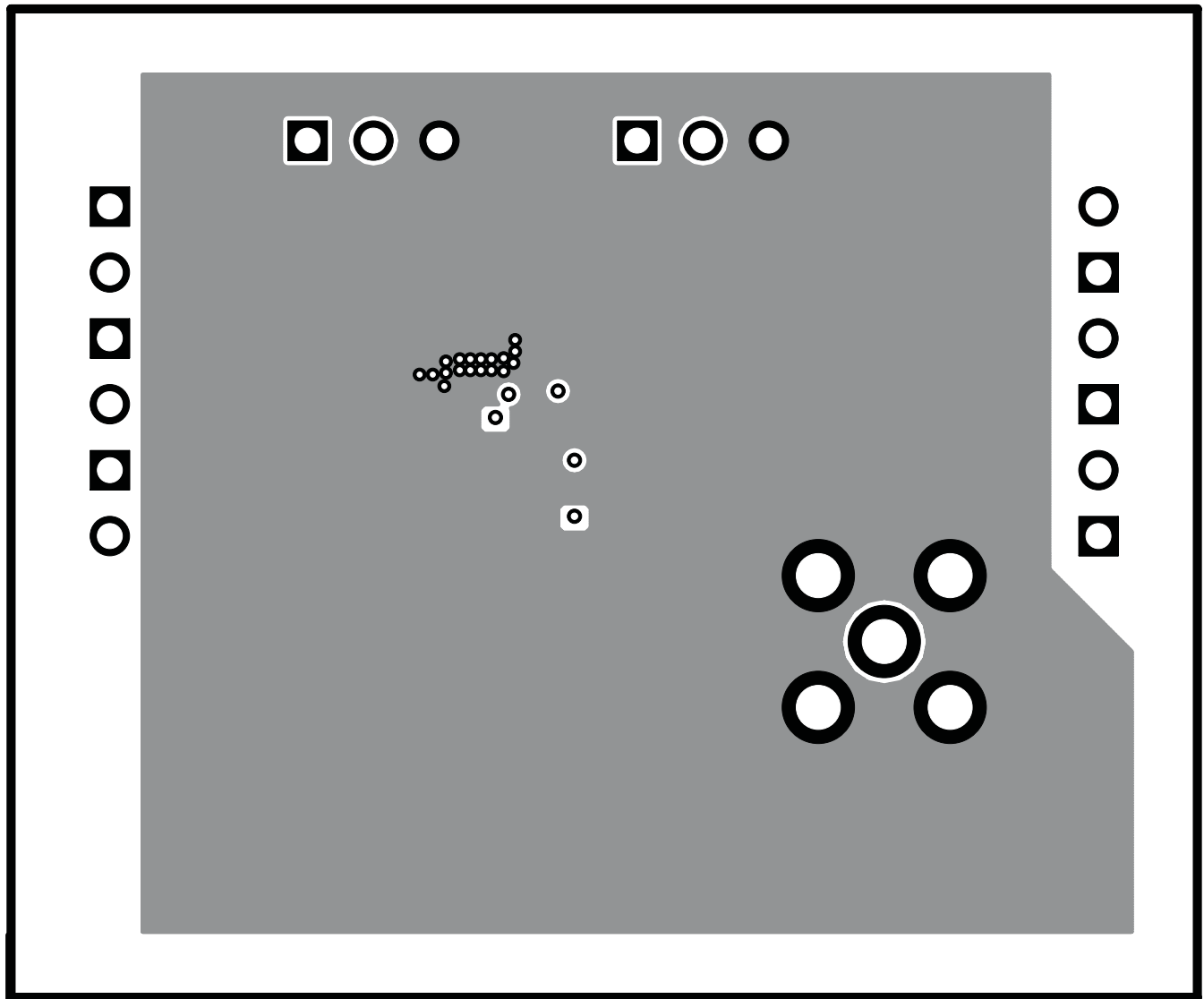

Figure 18. TLV62065EVM Internal Layer 1, X-Ray View From Top

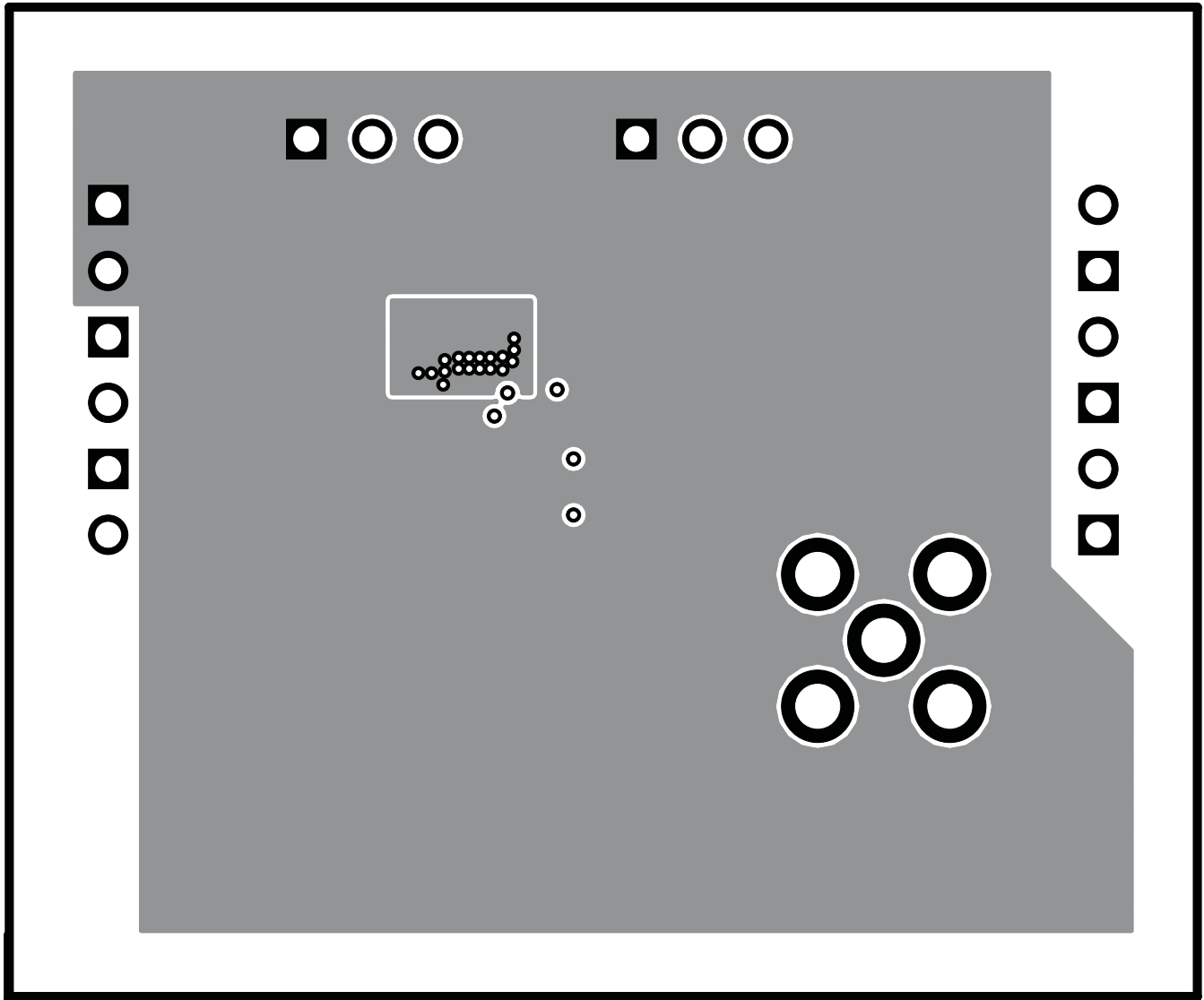

Figure 19. TLV62065EVM Internal Layer 2, X-Ray View From Top

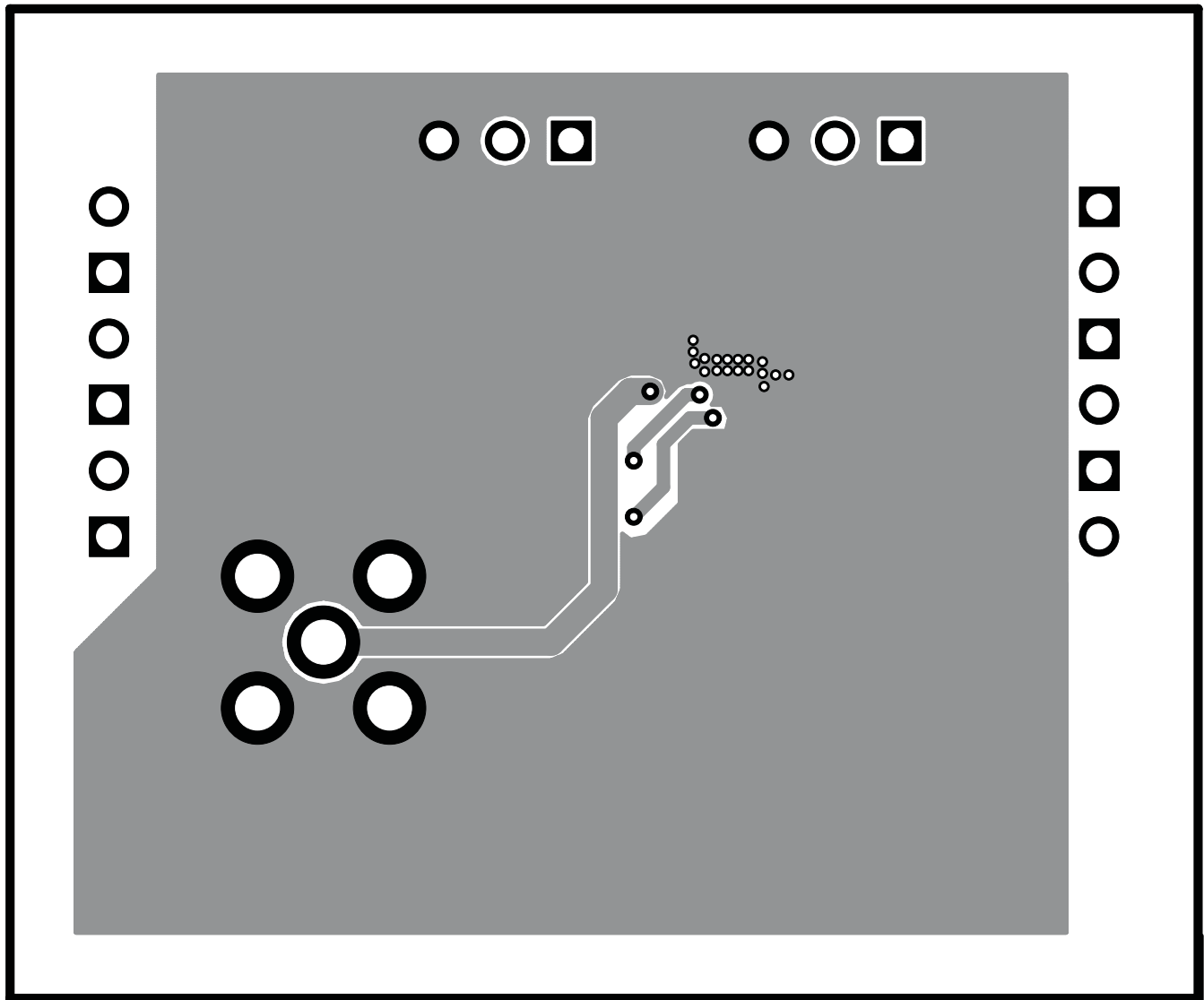

Figure 20. TLV62065EVM Bottom-Side Copper, Bottom View

## 7 Bill of Materials

Table 1 lists the bill of materials for the TLV62065EVM.

**Table 1. TLV62065EVM Bill of Materials**

Count	RefDes	Value	Description	Size	Part Number	MFR
2	C1, C2	10 $\mu$ F	Capacitor, ceramic, 6.3 V, X5R, 20%	0603	GRM188R60J106ME47D	muRata
0	C3	Open	Capacitor, ceramic, 6.3 V, X5R, 20%	0603	Std	Std
1	C4	22 $\mu$ F	Capacitor, ceramic, 10 V, X5R, 20%	1210	GRM32ER71A226K	muRata
1	C5	22 pF	Capacitor, ceramic, 50 V, NPO, 5%	0603	Std	Std
0	J7	Open	Connector, SMA , Straight, PC mount	0.210 in <sup>2</sup>	901-144-8RFX	AMP
1	L1	1.2 $\mu$ H	Inductor, SMT, 3.1 A, $\pm$ 30%	4x4 mm	NRG4026T-1R2N	Taiyo Yuden
1	R1	360 k $\Omega$	Resistor, chip, 1/16W, 1%	0603	Std	Std
1	R2	180 k $\Omega$	Resistor, chip, 1/16W, 1%	0603	Std	Std
2	R3, R4	1.00 M $\Omega$	Resistor, chip, 1/16W, 1%	0603	Std	Std
1	U1	TLV62065DSG	IC, step-down converter, 3 MHz, 1.6 A, low-cost	SON-8	TLV62065DSG	TI

## Evaluation Board/Kit Important Notice

Texas Instruments (TI) provides the enclosed product(s) under the following conditions:

This evaluation board/kit is intended for use for **ENGINEERING DEVELOPMENT, DEMONSTRATION, OR EVALUATION PURPOSES ONLY** and is not considered by TI to be a finished end-product fit for general consumer use. Persons handling the product(s) must have electronics training and observe good engineering practice standards. As such, the goods being provided are not intended to be complete in terms of required design-, marketing-, and/or manufacturing-related protective considerations, including product safety and environmental measures typically found in end products that incorporate such semiconductor components or circuit boards. This evaluation board/kit does not fall within the scope of the European Union directives regarding electromagnetic compatibility, restricted substances (RoHS), recycling (WEEE), FCC, CE or UL, and therefore may not meet the technical requirements of these directives or other related directives.

Should this evaluation board/kit not meet the specifications indicated in the User's Guide, the board/kit may be returned within 30 days from the date of delivery for a full refund. **THE FOREGOING WARRANTY IS THE EXCLUSIVE WARRANTY MADE BY SELLER TO BUYER AND IS IN LIEU OF ALL OTHER WARRANTIES, EXPRESSED, IMPLIED, OR STATUTORY, INCLUDING ANY WARRANTY OF MERCHANTABILITY OR FITNESS FOR ANY PARTICULAR PURPOSE.**

The user assumes all responsibility and liability for proper and safe handling of the goods. Further, the user indemnifies TI from all claims arising from the handling or use of the goods. Due to the open construction of the product, it is the user's responsibility to take any and all appropriate precautions with regard to electrostatic discharge.

**EXCEPT TO THE EXTENT OF THE INDEMNITY SET FORTH ABOVE, NEITHER PARTY SHALL BE LIABLE TO THE OTHER FOR ANY INDIRECT, SPECIAL, INCIDENTAL, OR CONSEQUENTIAL DAMAGES.**

TI currently deals with a variety of customers for products, and therefore our arrangement with the user **is not exclusive.**

TI assumes **no liability for applications assistance, customer product design, software performance, or infringement of patents or services described herein.**

Please read the User's Guide and, specifically, the Warnings and Restrictions notice in the User's Guide prior to handling the product. This notice contains important safety information about temperatures and voltages. For additional information on TI's environmental and/or safety programs, please contact the TI application engineer or visit [www.ti.com/esh](http://www.ti.com/esh).

No license is granted under any patent right or other intellectual property right of TI covering or relating to any machine, process, or combination in which such TI products or services might be or are used.

## FCC Warning

This evaluation board/kit is intended for use for **ENGINEERING DEVELOPMENT, DEMONSTRATION, OR EVALUATION PURPOSES ONLY** and is not considered by TI to be a finished end-product fit for general consumer use. It generates, uses, and can radiate radio frequency energy and has not been tested for compliance with the limits of computing devices pursuant to part 15 of FCC rules, which are designed to provide reasonable protection against radio frequency interference. Operation of this equipment in other environments may cause interference with radio communications, in which case the user at his own expense will be required to take whatever measures may be required to correct this interference.

## EVM Warnings and Restrictions

It is important to operate this EVM within the input voltage range of 2.9 V to 5.5 V and the output voltage range of 0.8 V to 5.5 V .

Exceeding the specified input range may cause unexpected operation and/or irreversible damage to the EVM. If there are questions concerning the input range, please contact a TI field representative prior to connecting the input power.

Applying loads outside of the specified output range may result in unintended operation and/or possible permanent damage to the EVM. Please consult the EVM User's Guide prior to connecting any load to the EVM output. If there is uncertainty as to the load specification, please contact a TI field representative.

During normal operation, some circuit components may have case temperatures greater than +60°C. The EVM is designed to operate properly with certain components above +60°C as long as the input and output ranges are maintained. These components include but are not limited to linear regulators, switching transistors, pass transistors, and current sense resistors. These types of devices can be identified using the EVM schematic located in the EVM User's Guide. When placing measurement probes near these devices during operation, please be aware that these devices may be very warm to the touch.

Mailing Address: Texas Instruments, Post Office Box 655303, Dallas, Texas 75265  
Copyright © 2010, Texas Instruments Incorporated

## IMPORTANT NOTICE

Texas Instruments Incorporated and its subsidiaries (TI) reserve the right to make corrections, modifications, enhancements, improvements, and other changes to its products and services at any time and to discontinue any product or service without notice. Customers should obtain the latest relevant information before placing orders and should verify that such information is current and complete. All products are sold subject to TI's terms and conditions of sale supplied at the time of order acknowledgment.

TI warrants performance of its hardware products to the specifications applicable at the time of sale in accordance with TI's standard warranty. Testing and other quality control techniques are used to the extent TI deems necessary to support this warranty. Except where mandated by government requirements, testing of all parameters of each product is not necessarily performed.

TI assumes no liability for applications assistance or customer product design. Customers are responsible for their products and applications using TI components. To minimize the risks associated with customer products and applications, customers should provide adequate design and operating safeguards.

TI does not warrant or represent that any license, either express or implied, is granted under any TI patent right, copyright, mask work right, or other TI intellectual property right relating to any combination, machine, or process in which TI products or services are used. Information published by TI regarding third-party products or services does not constitute a license from TI to use such products or services or a warranty or endorsement thereof. Use of such information may require a license from a third party under the patents or other intellectual property of the third party, or a license from TI under the patents or other intellectual property of TI.

Reproduction of TI information in TI data books or data sheets is permissible only if reproduction is without alteration and is accompanied by all associated warranties, conditions, limitations, and notices. Reproduction of this information with alteration is an unfair and deceptive business practice. TI is not responsible or liable for such altered documentation. Information of third parties may be subject to additional restrictions.

Resale of TI products or services with statements different from or beyond the parameters stated by TI for that product or service voids all express and any implied warranties for the associated TI product or service and is an unfair and deceptive business practice. TI is not responsible or liable for any such statements.

TI products are not authorized for use in safety-critical applications (such as life support) where a failure of the TI product would reasonably be expected to cause severe personal injury or death, unless officers of the parties have executed an agreement specifically governing such use. Buyers represent that they have all necessary expertise in the safety and regulatory ramifications of their applications, and acknowledge and agree that they are solely responsible for all legal, regulatory and safety-related requirements concerning their products and any use of TI products in such safety-critical applications, notwithstanding any applications-related information or support that may be provided by TI. Further, Buyers must fully indemnify TI and its representatives against any damages arising out of the use of TI products in such safety-critical applications.

TI products are neither designed nor intended for use in military/aerospace applications or environments unless the TI products are specifically designated by TI as military-grade or "enhanced plastic." Only products designated by TI as military-grade meet military specifications. Buyers acknowledge and agree that any such use of TI products which TI has not designated as military-grade is solely at the Buyer's risk, and that they are solely responsible for compliance with all legal and regulatory requirements in connection with such use.

TI products are neither designed nor intended for use in automotive applications or environments unless the specific TI products are designated by TI as compliant with ISO/TS 16949 requirements. Buyers acknowledge and agree that, if they use any non-designated products in automotive applications, TI will not be responsible for any failure to meet such requirements.



Following are URLs where you can obtain information on other Texas Instruments products and application solutions:

<b>Products</b>		<b>Applications</b>	
Amplifiers	<a href="http://amplifier.ti.com">amplifier.ti.com</a>	Audio	<a href="http://www.ti.com/audio">www.ti.com/audio</a>
Data Converters	<a href="http://dataconverter.ti.com">dataconverter.ti.com</a>	Automotive	<a href="http://www.ti.com/automotive">www.ti.com/automotive</a>
DLP® Products	<a href="http://www.dlp.com">www.dlp.com</a>	Communications and Telecom	<a href="http://www.ti.com/communications">www.ti.com/communications</a>
DSP	<a href="http://dsp.ti.com">dsp.ti.com</a>	Computers and Peripherals	<a href="http://www.ti.com/computers">www.ti.com/computers</a>
Clocks and Timers	<a href="http://www.ti.com/clocks">www.ti.com/clocks</a>	Consumer Electronics	<a href="http://www.ti.com/consumer-apps">www.ti.com/consumer-apps</a>
Interface	<a href="http://interface.ti.com">interface.ti.com</a>	Energy	<a href="http://www.ti.com/energy">www.ti.com/energy</a>
Logic	<a href="http://logic.ti.com">logic.ti.com</a>	Industrial	<a href="http://www.ti.com/industrial">www.ti.com/industrial</a>
Power Mgmt	<a href="http://power.ti.com">power.ti.com</a>	Medical	<a href="http://www.ti.com/medical">www.ti.com/medical</a>
Microcontrollers	<a href="http://microcontroller.ti.com">microcontroller.ti.com</a>	Security	<a href="http://www.ti.com/security">www.ti.com/security</a>
RFID	<a href="http://www.ti-rfid.com">www.ti-rfid.com</a>	Space, Avionics & Defense	<a href="http://www.ti.com/space-avionics-defense">www.ti.com/space-avionics-defense</a>
RF/IF and ZigBee® Solutions	<a href="http://www.ti.com/lprf">www.ti.com/lprf</a>	Video and Imaging	<a href="http://www.ti.com/video">www.ti.com/video</a>
		Wireless	<a href="http://www.ti.com/wireless-apps">www.ti.com/wireless-apps</a>

Mailing Address: Texas Instruments, Post Office Box 655303, Dallas, Texas 75265  
Copyright © 2010, Texas Instruments Incorporated

## Looking for pricing, stock, or lifecycle information?

Click below to explore more details on WIN SOURCE:

-  [View TLV62065EVM-719](#) on WIN SOURCE
-  [Texas Instruments](#) Information

## Optimize Your Supply Chain with WIN SOURCE Solutions

-  Global Sourcing Solution
-  Obsolete Management
-  Cost Control Management
-  Shortage Management
-  Alternative Solution
-  Excess Inventory Management