



**THE DATASHEET OF  
STK57FU394AG-E**



# ON Semiconductor

## Is Now

The logo for onsemi, featuring the word "onsemi" in a dark teal, lowercase, sans-serif font. The letter "i" is stylized with a white dot and a teal vertical bar. A small orange triangle is positioned above the top right of the "i". A trademark symbol (TM) is located to the right of the logo.

To learn more about onsemi™, please visit our website at  
[www.onsemi.com](http://www.onsemi.com)

---

**onsemi** and **onsemi** and other names, marks, and brands are registered and/or common law trademarks of Semiconductor Components Industries, LLC dba "**onsemi**" or its affiliates and/or subsidiaries in the United States and/or other countries. **onsemi** owns the rights to a number of patents, trademarks, copyrights, trade secrets, and other intellectual property. A listing of **onsemi** product/patent coverage may be accessed at [www.onsemi.com/site/pdf/Patent-Marking.pdf](http://www.onsemi.com/site/pdf/Patent-Marking.pdf). **onsemi** reserves the right to make changes at any time to any products or information herein, without notice. The information herein is provided "as-is" and **onsemi** makes no warranty, representation or guarantee regarding the accuracy of the information, product features, availability, functionality, or suitability of its products for any particular purpose, nor does **onsemi** assume any liability arising out of the application or use of any product or circuit, and specifically disclaims any and all liability, including without limitation special, consequential or incidental damages. Buyer is responsible for its products and applications using **onsemi** products, including compliance with all laws, regulations and safety requirements or standards, regardless of any support or applications information provided by **onsemi**. "Typical" parameters which may be provided in **onsemi** data sheets and/or specifications can and do vary in different applications and actual performance may vary over time. All operating parameters, including "Typicals" must be validated for each customer application by customer's technical experts. **onsemi** does not convey any license under any of its intellectual property rights nor the rights of others. **onsemi** products are not designed, intended, or authorized for use as a critical component in life support systems or any FDA Class 3 medical devices or medical devices with a same or similar classification in a foreign jurisdiction or any devices intended for implantation in the human body. Should Buyer purchase or use **onsemi** products for any such unintended or unauthorized application, Buyer shall indemnify and hold **onsemi** and its officers, employees, subsidiaries, affiliates, and distributors harmless against all claims, costs, damages, and expenses, and reasonable attorney fees arising out of, directly or indirectly, any claim of personal injury or death associated with such unintended or unauthorized use, even if such claim alleges that **onsemi** was negligent regarding the design or manufacture of the part. **onsemi** is an Equal Opportunity/Affirmative Action Employer. This literature is subject to all applicable copyright laws and is not for resale in any manner. Other names and brands may be claimed as the property of others.

# STK57FU394AG-E

## 2-in-1 PFC and Inverter Intelligent Power Module (IPM), 600 V, 15 A

The STK57FU394AG-E is a fully-integrated PFC and inverter power stage consisting of a high-voltage driver, six motor drive IGBT's, one PFC IGBT, one PFC rectifier and a thermistor, suitable for driving permanent magnet synchronous (PMSM) motors, brushless-DC (BLDC) motors and AC asynchronous motors.

The IGBT's are configured in a 3-phase bridge with separate emitter connections for the lower legs for maximum flexibility in the choice of control algorithm.

An internal comparator and reference connected to the over-current protection circuit allows the designer to set individual over-current protection levels for the PFC and the inverter stages. Additionally, the power stage has a full range of protection functions including cross-conduction protection, external shutdown and under-voltage lockout functions.

### Features

- Simple thermal design with PFC and inverter stage in one package.
- PFC operating frequency up to 40kHz
- Cross-conduction protection
- Adjustable over-current protection level
- Integrated bootstrap diodes and resistors

### Certification

- UL1557 (File Number : E339285)

### Typical Applications

- Heat Pumps
- Home Appliances
- Industrial Fans
- Industrial Pumps

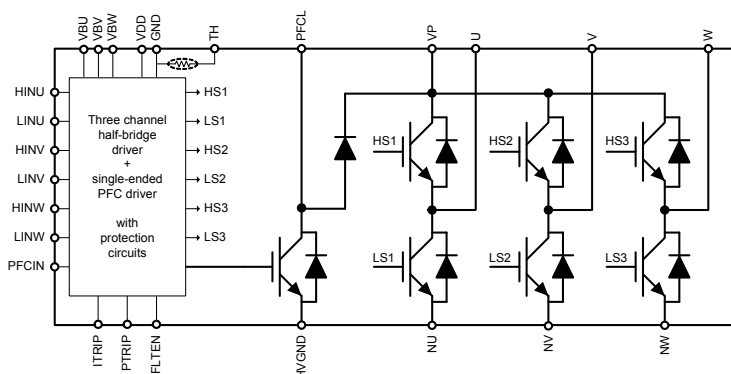

Figure 1. Functional Diagram



ON Semiconductor®

www.onsemi.com

### PACKAGE PICTURE

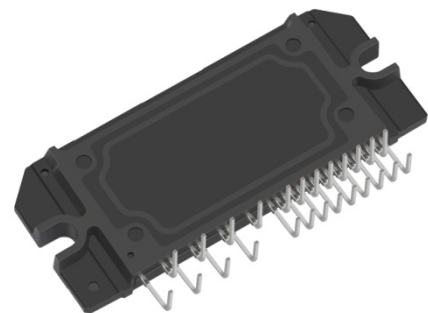

SIP35 56x25.8 / SIP2A-3

### MARKING DIAGRAM

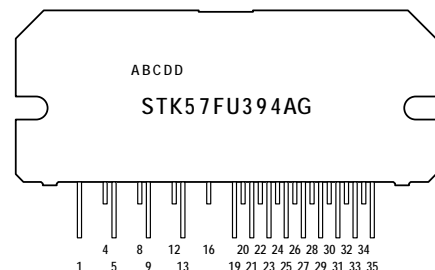

STK57FU394AG = Specific Device Code

A = Year

B = Month

C = Production Site

DD = Factory Lot Code

Device marking is on package top side

### ORDERING INFORMATION

Device	Package	Shipping (Qty / Packing)
STK57FU394AG-E	SIP35 56x25.8 / SIP2A-3 (Pb-Free)	8 / Tube

# STK57FU394AG-E

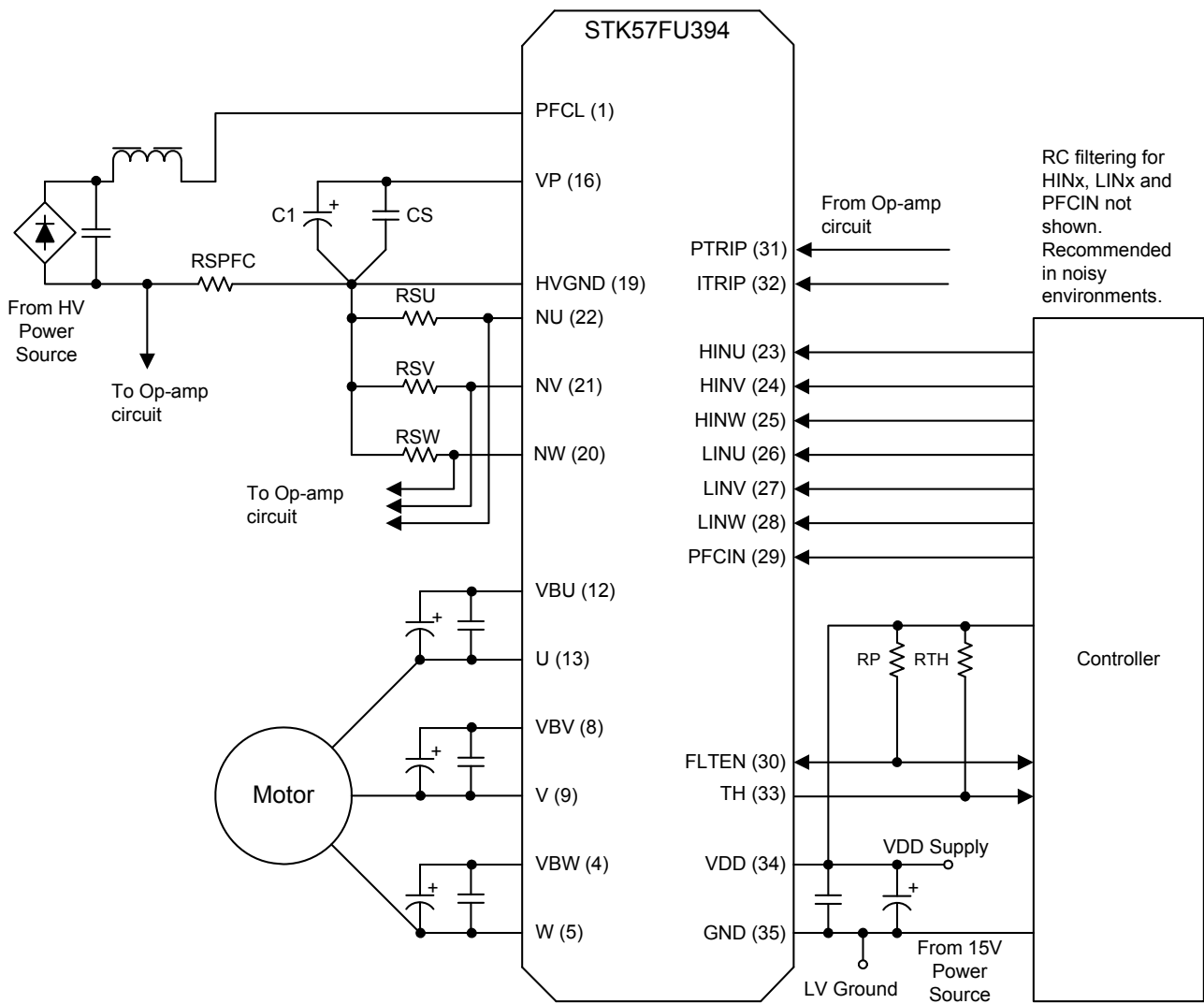

Figure 2. Application Schematic



# STK57FU394AG-E

## PIN FUNCTION DESCRIPTION

Pin	Name	Description
1	PFCL	PFC Inductor Connection to IGBT and Rectifier node
4	VBW	High Side Floating Supply voltage for W phase
5	W	V phase output. Internally connected to W phase high side driver ground
8	VBV	High Side Floating Supply voltage for V phase
9	V	V phase output. Internally connected to V phase high side driver ground
12	VBU	High Side Floating Supply voltage for U phase
13	U	U phase output. Internally connected to U phase high side driver ground
16	VP	Positive PFC Output Voltage
19	HVGND	Negative PFC Output Voltage
20	NW	Low Side Emitter Connection - Phase W
21	NV	Low Side Emitter Connection - Phase V
22	NU	Low Side Emitter Connection - Phase U
23	HINU	Logic Input High Side Gate Driver - Phase U
24	HINV	Logic Input High Side Gate Driver - Phase V
25	HINW	Logic Input High Side Gate Driver - Phase W
26	LINU	Logic Input Low Side Gate Driver - Phase U
27	LINV	Logic Input Low Side Gate Driver - Phase V
28	LINW	Logic Input Low Side Gate Driver - Phase W
29	PFCIN	Logic Input PFC Gate Driver
30	FLTEN	Bidirectional FAULT output and ENABLE input
31	PTRIP	Current protection pin for PFC
32	ITRIP	Current protection pin for inverter
33	TH	Thermistor output
34	VDD	+15V Main Supply
35	GND	Negative Main Supply

Note: Pins 2, 3, 6, 7, 10, 11, 14, 15, 17 and 18 are not present

# STK57FU394AG-E

## ABSOLUTE MAXIMUM RATINGS (Notes 1, 2)

Tc=25°C unless otherwise noted.

Rating	Symbol	Conditions	Value	Unit	
<b>PFC Section</b>					
PFC IGBT	Collector-emitter voltage	V <sub>CE</sub>	PFCL to HVGND	600	V
	Repetitive peak collector current	ICP	Duty cycle 10%, pulse width 1ms	72	A
	Collector current	IC		36	A
			Tc=100°C	18	A
Maximum power dissipation	PC		73	W	
PFC Diode	Diode reverse voltage	VRM	VP to PFCL	600	V
	Repetitive peak forward current	IFP1	Duty cycle 10%, pulse width 1ms	60	A
	Diode forward current	IF1		30	A
			Tc=100°C	15	A
Maximum power dissipation	PD1		56	W	
Anti-parallel Diode	Repetitive peak forward current	IFP2	Duty cycle 10%, pulse width 1ms	11	A
	Diode forward current	IF2		5	A
	Maximum power dissipation	PD2		10	W
Maximum AC input voltage	VAC	Single-phase Full-rectified	264	V	
Maximum output voltage	Vo	In the Application Circuit (VAC=200V)	450	V	
Input AC current (steady state)	Iin		15	Arms	

## Inverter Section

Supply voltage	V <sub>CC</sub>	VP to NU, NV, NW surge < 500V (Note 3)	450	V
Collector-emitter voltage	V <sub>CE max</sub>	VP to U, V, W or U to NU, V to NV, W to NW	600	V
Output current	Io	VP, U, V, W, NU, NV, NW terminal current	±15	A
		VP, U, V, W, NU, NV, NW terminal current at Tc=100°C	±8	A
Output peak current	Iop	VP, U, V, W, NU, NV, NW terminal current, pulse width 1ms	±30	A
Maximum power dissipation	Pd	IGBT per 1 channel	35	W

## Gate driver section

Gate driver supply voltage	V <sub>BS</sub> , V <sub>DD</sub>	VBU to U, VBV to V, VBW to W, VDD to GND (Note 4)	-0.3 to +20.0	V
Input signal voltage	VIN	HINU, HINV, HINW, LINU, LINV, LINW, PFCIN	-0.3 to V <sub>DD</sub>	V
FLTEN terminal voltage	VFLTEN	FLTEN terminal	-0.3 to V <sub>DD</sub>	V
ITRIP terminal voltage	VITRIP	ITRIP terminal	-0.3 to +10.0	V
PFCTRIP terminal voltage	VPTRIP	PTRIP terminal	-1.5 to +2.0	V

## Intelligent Power Module

Junction temperature	Tj	IGBT, FRD, Gate driver IC	150	°C
Storage temperature	Tstg		-45 to +125	°C
Operating case temperature	Tc	IPM case temperature	-30 to +100	°C
Tightening torque	MT	Case mounting screws	0.9	Nm
Isolation voltage	Vis	50Hz sine wave AC 1 minute (Note 5)	2000	Vrms

1. Stresses exceeding those listed in the Maximum Ratings table may damage the device. If any of these limits are exceeded, device functionality should not be assumed, damage may occur and reliability may be affected.
2. Refer to ELECTRICAL CHARACTERISTICS, RECOMMENDED OPERATING RANGES and/or APPLICATION INFORMATION for Safe Operating parameters.
3. This surge voltage developed by the switching operation due to the wiring inductance between VP and NU, NV, NW terminals.
4. VBS=VBU to U, VBV to V, VBW to W
5. Test conditions : AC2500V, 1 s

## STK57FU394AG-E

### RECOMMENDED OPERATING RANGES (Note 6)

Rating	Symbol		Min	Typ	Max	Unit
Supply voltage	V <sub>CC</sub>	VP to HVGND, NU, NV, NW	0	280	400	V
Gate driver supply voltage	V <sub>BS</sub>	VBU to U, VBV to V, VBW to W	12.5	15	17.5	V
	V <sub>DD</sub>	V <sub>DD</sub> to GND (Note 6)	13.5	15	16.5	V
ON-state input voltage	VIN(ON)	HINU, HINV, HINW, LINU, LINV, LINW, PFCIN	2.5	-	5.0	V
OFF-state input voltage	VIN(OFF)		0	-	0.3	V
PWM frequency(PFC)	fP <sub>WMp</sub>		1	-	40	kHz
PWM frequency(Inverter)	fP <sub>WMi</sub>		1	-	20	kHz
Dead time	DT	Turn-off to Turn-on (external)	1.5	-	-	μs
Allowable input pulse width	PWIN	ON and OFF	1	-	-	μs
Tightening torque		'M3' type screw	0.6	-	0.9	Nm

6. Functional operation above the stresses listed in the Recommended Operating Ranges is not implied. Extended exposure to stresses beyond the Recommended Operating Ranges limits may affect device reliability.

# STK57FU394AG-E

## ELECTRICAL CHARACTERISTICS (Note 7)

T<sub>c</sub>=25°C, V<sub>BIAS</sub> (V<sub>BS</sub>, V<sub>DD</sub>)=15V unless otherwise noted.

Parameter	Test Conditions	Symbol	Min	Typ	Max	Unit
<b>PFC Section</b>						
Collector-emitter cut-off current	V <sub>CE</sub> =600V	I <sub>CE</sub>	-	-	0.1	mA
Reverse leakage current (PFC Diode)	V <sub>R</sub> =600V	I <sub>R</sub>	-	-	0.1	mA
Collector-emitter saturation voltage	I <sub>C</sub> =30A, T <sub>j</sub> =25°C	V <sub>CE(sat)</sub>	-	1.9	2.5	V
	I <sub>C</sub> =15A, T <sub>j</sub> =100°C		-	1.6	-	V
Diode forward voltage (PFC Diode)	I <sub>F</sub> =30A, T <sub>j</sub> =25°C	V <sub>F1</sub>	-	2.0	2.6	V
	I <sub>F</sub> =15A, T <sub>j</sub> =100°C		-	1.5	-	
Diode forward voltage (Anti-parallel Diode)	I <sub>F</sub> =5A, T <sub>j</sub> =25°C	V <sub>F2</sub>	-	1.7	2.3	V
Junction to case thermal resistance	IGBT	θ <sub>j-c(T)</sub>	-	-	1.7	°C/W
	PFC Diode	θ <sub>j-c(D)</sub>	-	-	2.2	°C/W
Switching characteristics						
Switching time	I <sub>C</sub> =30A, V <sub>P</sub> =300V, T <sub>j</sub> =25°C	t <sub>ON</sub>	0.1	0.3	0.8	μs
		t <sub>OFF</sub>	0.1	0.4	0.9	μs
Diode reverse recovery time		trr	-	60	-	ns
<b>Inverter section</b>						
Collector-emitter leakage current	V <sub>CE</sub> =600V	I <sub>CE</sub>	-	-	100	μA
Bootstrap diode reverse current	V <sub>R(DB)</sub> =600V	I <sub>R(BD)</sub>	-	-	100	μA
Collector to emitter saturation voltage	I <sub>C</sub> =15A, T <sub>j</sub> =25°C	V <sub>CE(SAT)</sub>	-	2.0	2.6	V
	I <sub>C</sub> =8A, T <sub>j</sub> =100°C		-	1.7	-	V
Diode forward voltage	I <sub>F</sub> =15A, T <sub>j</sub> =25°C	V <sub>F</sub>	-	2.1	2.7	V
	I <sub>F</sub> =8A, T <sub>j</sub> =100°C		-	1.7	-	V
Junction to case thermal resistance	IGBT	θ <sub>j-c(T)</sub>	-	-	3.5	°C/W
Junction to case thermal resistance	FRD	θ <sub>j-c(D)</sub>	-	-	7.2	°C/W
Switching time	I <sub>C</sub> = 15A, V <sub>CC</sub> =300V, T <sub>j</sub> =25°C	t <sub>ON</sub>	0.1	0.5	1.0	μs
		t <sub>OFF</sub>	0.2	0.7	1.2	μs
Turn-on switching loss	I <sub>C</sub> = 15A, V <sub>CC</sub> =300V, T <sub>j</sub> =25°C	E <sub>ON</sub>	-	200	-	μJ
Turn-off switching loss		E <sub>OFF</sub>	-	150	-	μJ
Total switching loss		E <sub>TOT</sub>	-	350	-	μJ
Turn-on switching loss	I <sub>C</sub> = 15A, V <sub>CC</sub> =300V, T <sub>j</sub> =100°C	E <sub>ON</sub>	-	300	-	μJ
Turn-off switching loss		E <sub>OFF</sub>	-	200	-	μJ
Total switching loss		E <sub>TOT</sub>	-	500	-	μJ
Diode reverse recovery energy	I <sub>C</sub> = 15A, V <sub>CC</sub> =300V, T <sub>j</sub> =100°C	E <sub>REC</sub>	-	100	-	μJ
Diode reverse recovery time	(di/dt set by internal driver)	trr	-	200	-	ns
Reverse bias safe operating area	I <sub>c</sub> =30A, V <sub>CE</sub> =450V	RBSOA	Full Square	-		
Short circuit safe operating area	V <sub>CE</sub> =400V, T <sub>j</sub> =100°C	SCSOA	4	-	-	μs
Allowable offset voltage slew rate	U to NU, V to NV, W to NW	dv/dt	-50	-	50	V/ns

# STK57FU394AG-E

Parameter	Test Conditions	Symbol	Min	Typ	Max	Unit
<b>Driver Section</b>						
Gate driver consumption current	V <sub>BS</sub> =15V (Note 4), per driver	ID	-	0.08	0.4	mA
	V <sub>DD</sub> =15V, total	ID	-	0.85	2.4	mA
High level Input voltage	HINU, HINV, HINW, LINU, LINV, LINW, PFCIN to GND	VIN H	2.5	-	-	V
Low level Input voltage		VIN L	-	-	0.8	V
Logic 1 input current	VIN=+3.3V	I <sub>IN+</sub>	-	100	143	μA
Logic 0 input current	VIN=0V	I <sub>IN-</sub>	-	-	2	μA
Bootstrap diode forward voltage	IF=0.1A	VF(DB)	-	0.8	-	V
Bootstrap circuit resistance	Resistor value for common boot charge line	RBC	-	22	-	Ω
	Resister values for separate boot charge lines	RBS	-	22	-	Ω
FLTEN terminal sink current	FLTEN : ON / VFAULT=0.1V	IoSD	-	2	-	mA
FLTEN clearance delay time		FLTCLR	1.3	1.65	2.0	ms
FLTEN Threshold	VEN ON-state voltage	VEN(ON)	2.5	-	-	V
	VEN OFF-state voltage	VEN(OFF)	-	-	0.8	V
ITRIP threshold voltage	ITRIP to GND	VITRIP	0.44	0.49	0.54	V
PTRIP threshold voltage	PTRIP to GND	VPTRIP	-0.37	-0.31	-0.25	V
ITRIP to shutdown propagation delay		t <sub>ITRIP</sub>	490	600	850	ns
PTRIP to shutdown propagation delay		t <sub>PTRIP</sub>	440	550	800	ns
ITRIP and PTRIP blanking time		t <sub>ITRIPBL</sub> t <sub>PFCITRIPBL</sub>	290	350	-	ns
V <sub>DD</sub> and V <sub>BS</sub> supply undervoltage positive going input threshold		V <sub>DDUV+</sub> V <sub>BSUV+</sub>	10.5	11.1	11.7	V
V <sub>DD</sub> and V <sub>BS</sub> supply undervoltage negative going input threshold		V <sub>DDUV-</sub> V <sub>BSUV-</sub>	10.3	10.9	11.5	V
V <sub>DD</sub> and V <sub>BS</sub> supply undervoltage lockout hysteresis		V <sub>DDUVH</sub> V <sub>BSUVH</sub>	0.14	0.2	-	V

7. Product parametric performance is indicated in the Electrical Characteristics for the listed test conditions, unless otherwise noted. Product performance may not be indicated by the Electrical Characteristics if operated under different conditions.

TYPICAL CHARACTERISTICS PFC SECTION

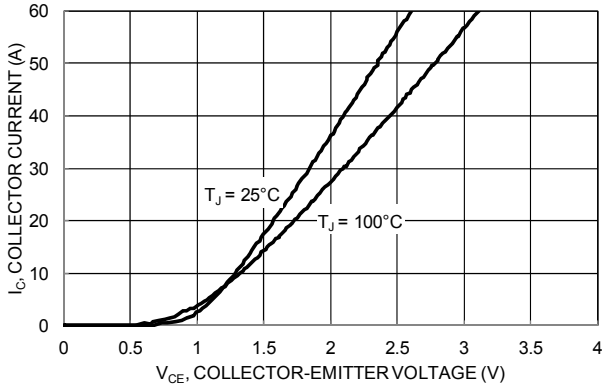

Figure 4.  $V_{CE}$  versus  $I_C$  for different temperatures ( $V_{DD}=15V$ )

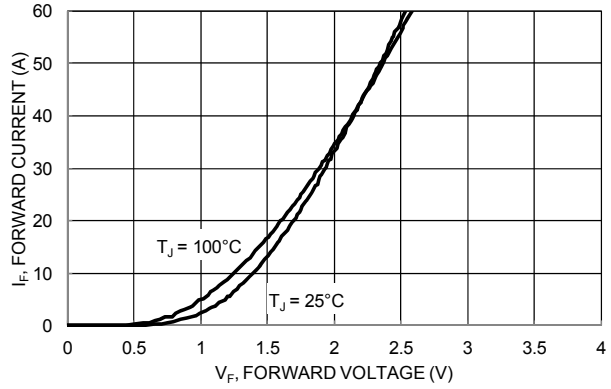

Figure 5. PFC Diode  $V_F$  versus  $I_F$  for different temperatures

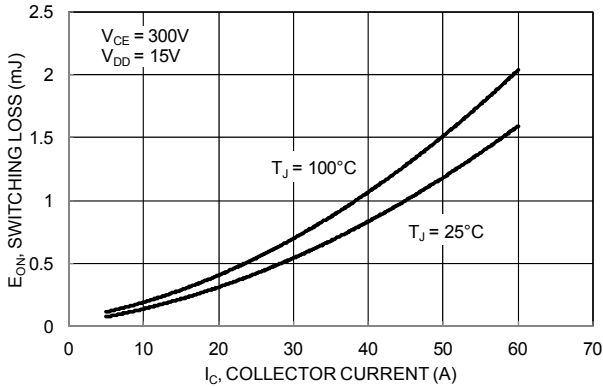

Figure 6.  $E_{ON}$  versus  $I_C$  for different temperatures

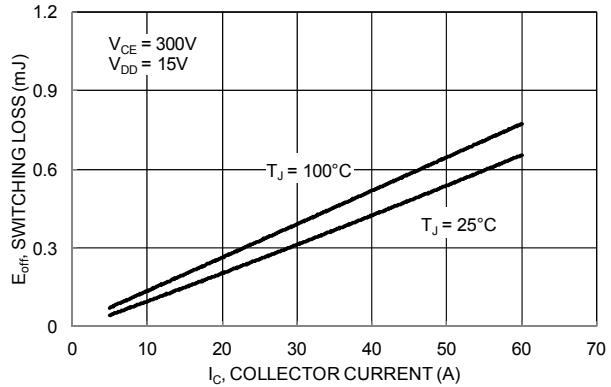

Figure 7.  $E_{OFF}$  versus  $I_C$  for different temperatures

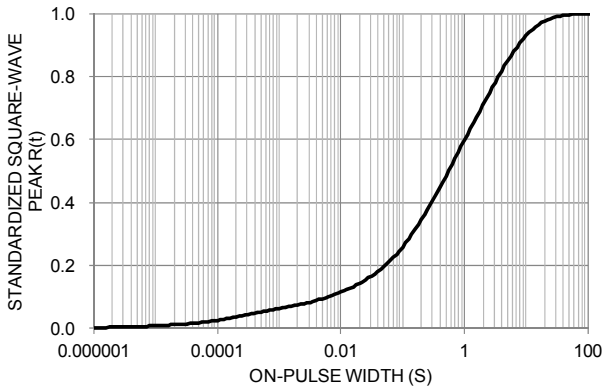

Figure 8. Thermal Impedance Plot

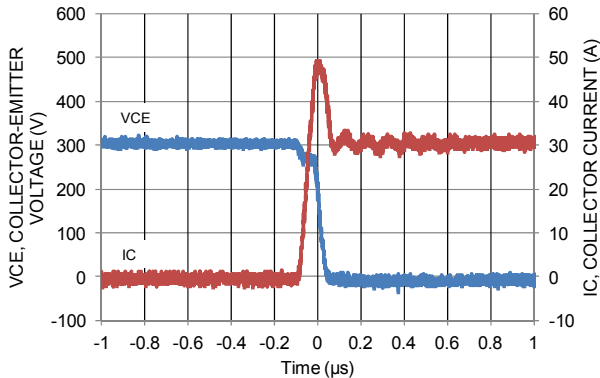

Figure 9. Turn-on waveform  $T_J=100^\circ C$ ,  $V_{CC}=300V$

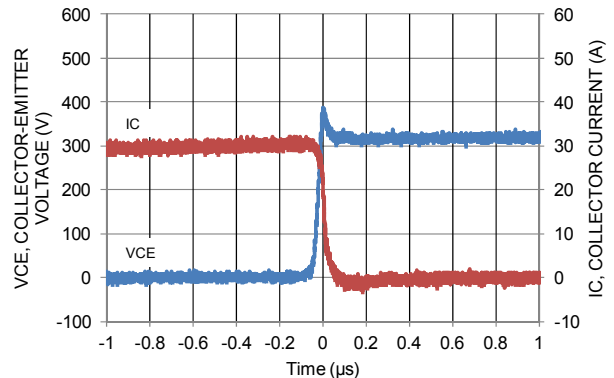

Figure 10. Turn-off waveform  $T_J=100^\circ C$ ,  $V_{CC}=300V$

TYPICAL CHARACTERISTICS INVERTER SECTION

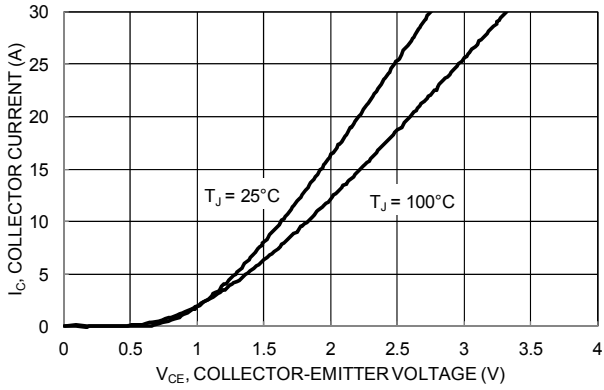

Figure 11. VCE versus ID for different temperatures (VDD=15V)

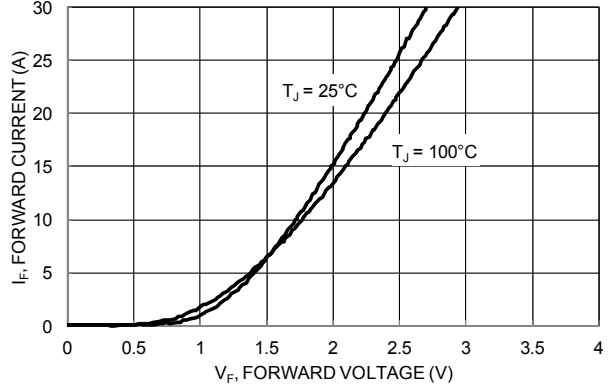

Figure 12. VF versus ID for different temperatures

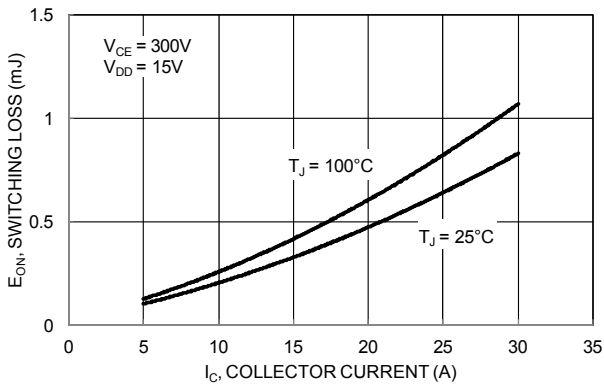

Figure 13. EON versus ID for different temperatures

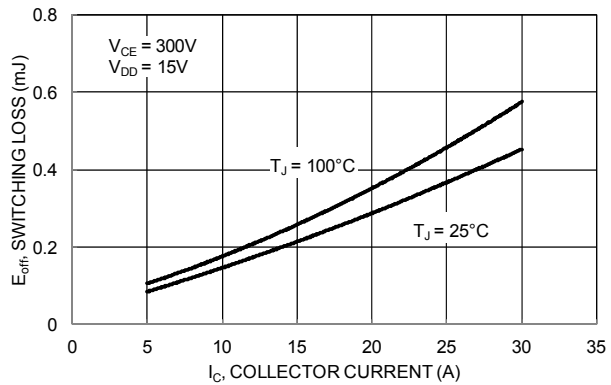

Figure 14. EOFF versus ID for different temperatures

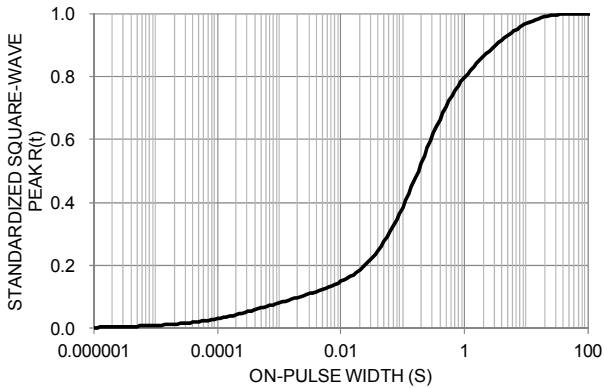

Figure 15. Thermal Impedance Plot

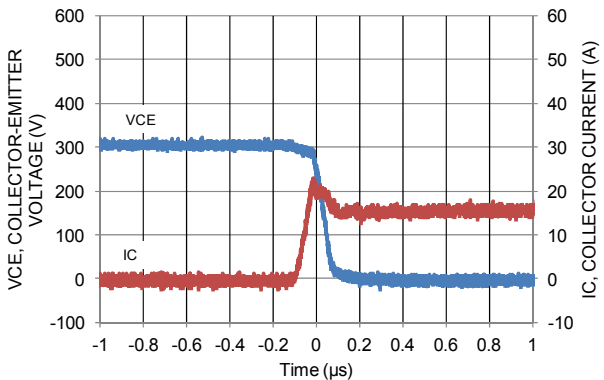

Figure 16. Turn-on waveform TJ=100°C, VCC=300V

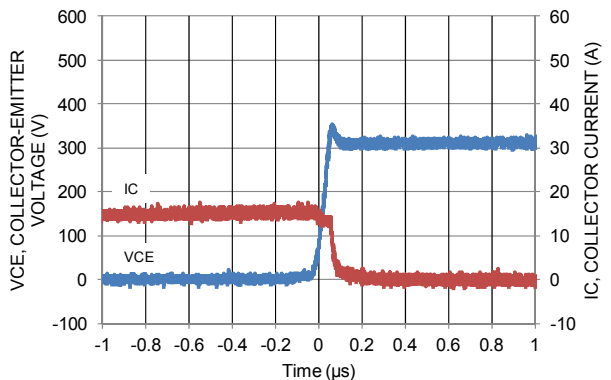

Figure 17. Turn-off waveform TJ=100°C, VCC=300V

APPLICATIONS INFORMATION

Input / Output Timing Chart

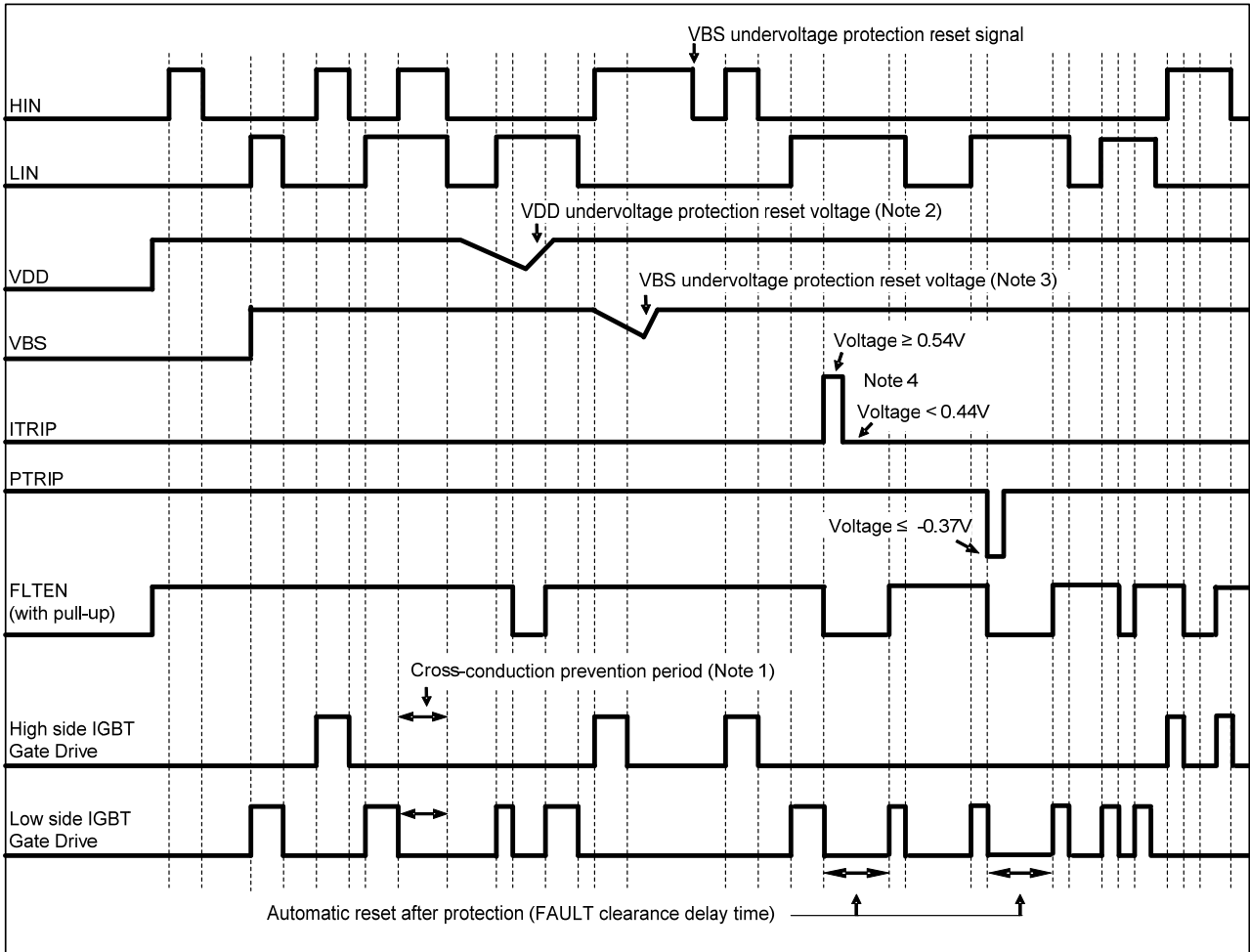

Figure 18. Input / Output Timing Chart

Notes

1. This section of the timing diagram shows the effect of cross-conduction prevention.
2. This section of the timing diagram shows that when the voltage on  $V_{DD}$  decreases sufficiently all gate output signals will go low, switching off all six IGBTs. When the voltage on  $V_{DD}$  rises sufficiently, normal operation will resume.
3. This section shows that when the bootstrap voltage on VBU (VBV, VBW) drops, the corresponding high side output U (V, W) is switched off. When the voltage on VBU (VBV, VBW) rises sufficiently, normal operation will resume.
4. This section shows that when the voltage on ITRIP exceeds the threshold, all IGBT's are turned off. Normal operation resumes later after the over-current condition is removed. Similarly, when the voltage on PTRIP exceeds the threshold, all IGBT's are turned off. Normal operation resumes later after the over-current condition is removed.
5. After  $V_{DD}$  has risen above the threshold to enable normal operation, the driver waits to receive an input signal on the LIN input before enabling the driver for the HIN signal.

Input / Output Logic Table

INPUT				OUTPUT			
HIN	LIN	ITRIP	PTRIP	High side IGBT	Low side IGBT	U,V,W	FAULT
H	L	L	L	ON (Note 5)	OFF	VP	OFF
L	H	L	L	OFF	ON	NU,NV,NW	OFF
L	L	L	L	OFF	OFF	High Impedance	OFF
H	H	L	L	OFF	OFF	High Impedance	OFF
X	X	H	X	OFF	OFF	High Impedance	ON
X	X	X	H	OFF	OFF	High Impedance	ON

# STK57FU394AG-E

## Thermistor characteristics

Parameter	Symbol	Condition	Min	Typ	Max	Unit
Resistance	R25	Tc=25°C	99	100	101	kΩ
	R100	Tc=100°C	5.18	5.38	5.60	kΩ
B-Constant (25 to 50°C)	B		4208	4250	4293	K
Temperature Range			-40		+125	°C

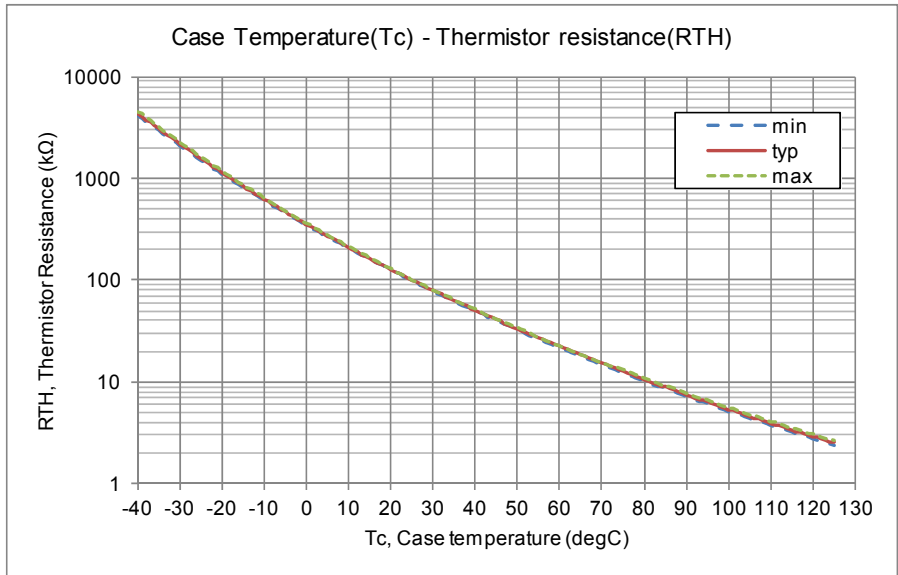

**Figure 19. Thermistor Resistance versus Case Temperature**

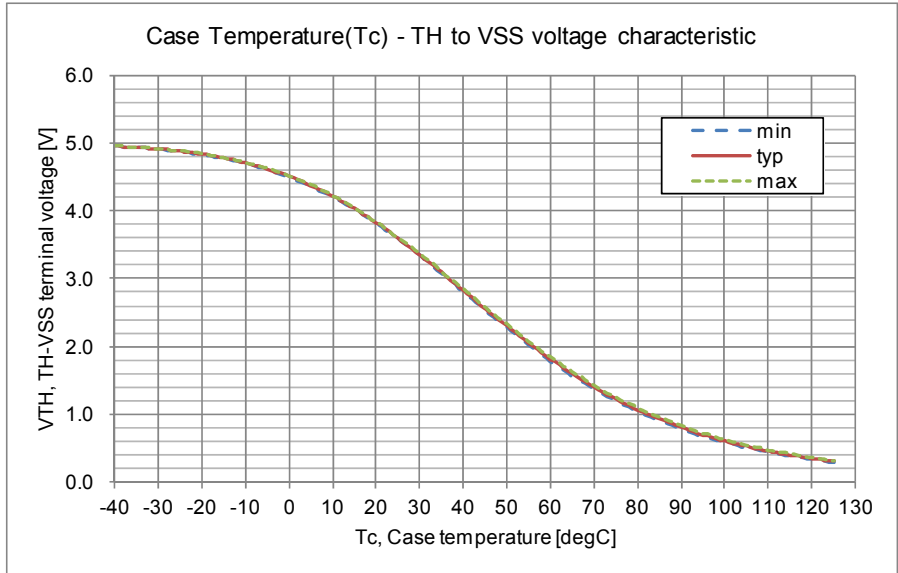

**Figure 20. Thermistor Voltage versus Case Temperature**  
**Conditions: RTH=39kΩ, pull-up voltage 5.0V (see Figure 2)**

## Signal inputs

Each signal input has a pull-down resistor. An additional pull-down resistor of between 2.2kΩ and 3.3kΩ is recommended on each input to improve noise immunity.

## FLTEN pin

The FLTEN pin is connected to an open-drain FAULT output requiring a pull-up resistor and an ENABLE input. If the pull-up voltage is 5V, use a pull-up resistor with a value of 6.8kΩ or higher. If the pull-up voltage is 15V, use a pull-up resistor with a value of 20kΩ or higher. The pulled up voltage in normal operation for the FLTEN pin should be above 2.5V, noting that it is connected to an internal ENABLE input. The FAULT output is triggered if there is a VDD undervoltage or an overcurrent condition on either the PFC or inverter stages.

Driving the FLTEN terminal pin is used to enable or shut down the built-in driver. If the voltage on the FLTEN pin rises above the positive going FLTEN threshold, the output drivers are enabled. If the voltage on the FLTEN pin falls below the negative going FLTEN threshold, the drivers are disabled.

## Undervoltage protection

If VDD goes below the VDD supply undervoltage lockout falling threshold, the FAULT output is switched on. The FAULT output stays on until VDD rises above the VDD supply undervoltage lockout rising threshold. The hysteresis is approximately 200mV.

## Overcurrent protection

An over-current condition is detected if the voltage on the ITRIP/PTRIP pin is larger than the reference voltage. There is a blanking time of typically 350ns to improve noise immunity. After a shutdown propagation delay of typically 0.6 us, the FAULT output is switched on.

The over-current protection threshold should be set to be equal or lower to 2 times the module rated current (Io).

An additional fuse is recommended to protect against system level or abnormal over-current fault conditions.

## Capacitors on High Voltage and VDD supplies

Both the high voltage and VDD supplies require an electrolytic capacitor and an additional high frequency capacitor. The recommended value of the high frequency capacitor is between 100nF and 10 μF.

## Minimum input pulse width

When input pulse width is less than 1μs, an output may not react to the pulse. (Both ON signal and OFF signal)

## Calculation of bootstrap capacitor value

The bootstrap capacitor value CB is calculated using the following approach. The following parameters influence the choice of bootstrap capacitor:

- V<sub>BS</sub>: Bootstrap power supply. 15V is recommended.
- QG: Total gate charge of IGBT at V<sub>BS</sub>=15V. 53nC
- UVLO: Falling threshold for UVLO. Specified as 12V.
- IDMAX: High side drive power dissipation. Specified as 0.4mA
- TONMAX: Maximum ON pulse width of high side IGBT.

Capacitance calculation formula:

$$CB = (QG + IDMAX * TONMAX)/(V_{BS} - UVLO)$$

CB is recommended to be approximately 3 times the value calculated above. The recommended value of CB is in the range of 1 to 47μF, however, the value needs to be verified prior to production. When not using the bootstrap circuit, each high side driver power supply requires an external independent power supply. If the capacitors selected are 47 μF or more, a series resistor of 20Ω should be added in series with the three capacitors to limit the current. The resistors should be inserted between VBU and U, VBV and V and VBW and W.

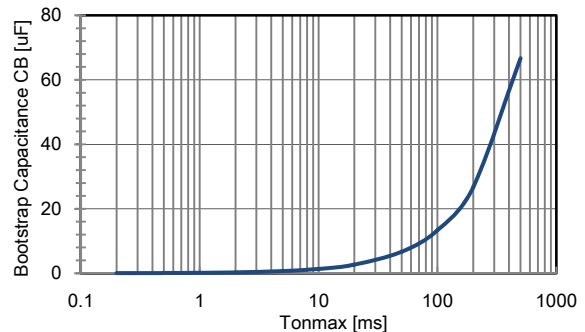

Figure 21. Bootstrap capacitance versus Tonmax

# STK57FU394AG-E

## Mounting Instructions

Item	Recommended Condition
Pitch	56.0±0.1mm (Please refer to Package Outline Diagram)
Screw	diameter : M3 Screw head types: pan head, truss head, binding head
Washer	Plane washer The size is D:7mm, d:3.2mm and t:0.5mm JIS B 1256
Heat sink	Material: Aluminum or Copper Warpage (the surface that contacts IPM) : -50 to 100 μm Screw holes must be countersunk. No contamination on the heat sink surface that contacts IPM.
Torque	Temporary tightening : 20 to 30 % of final tightening on first screw Temporary tightening : 20 to 30 % of final tightening on second screw Final tightening : 0.6 to 0.9Nm on first screw Final tightening : 0.6 to 0.9Nm on second screw
Grease	Silicone grease. Thickness : 100 to 200 μm Uniformly apply silicone grease to whole back. Thermal foils are only recommended after careful evaluation. Thickness, stiffness and compressibility parameters have a strong influence on performance.

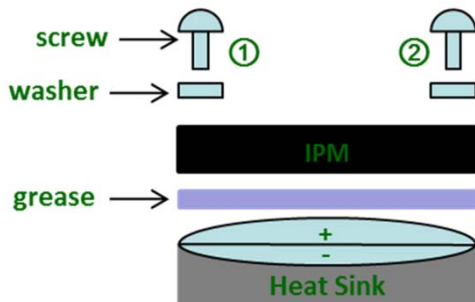

Figure 22. Mount IPM on a Heat Sink

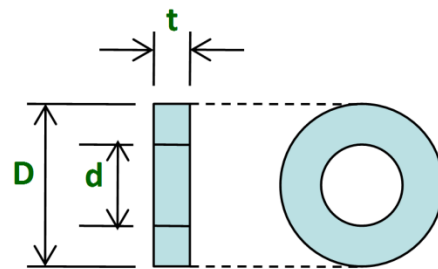

Figure23. Size of Washer

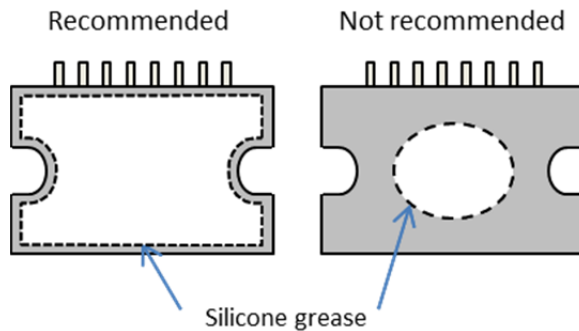

Figure24. Uniform Application of Grease Recommended

Steps to mount an IPM on a heat sink

1st: Temporarily tighten maintaining a left/right balance.

2nd: Finally tighten maintaining a left/right balance.

TEST CIRCUITS

■  $I_{CE}$ ,  $I_{R(DB)}$

	U+	V+	W+	U-	V-	W-	PFC IGBT
A	16	16	16	13	9	5	1
B	13	9	5	22	21	20	19

U+,V+,W+ : High side phase  
 U-,V-,W- : Low side phase

	U(DB)	V(DB)	W(DB)	PFC Diode
A	12	8	4	16
B	35	35	35	1

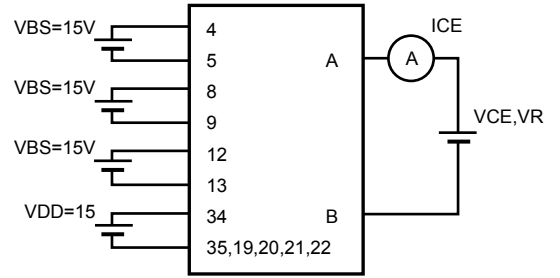

Figure 25. Test Circuit for  $I_{CE}$

■  $V_{CE(sat)}$  (Test by pulse)

	U+	V+	W+	U-	V-	W-	PFC IGBT
A	16	16	16	13	9	5	1
B	13	9	5	22	21	20	19
C	23	24	25	26	27	28	29

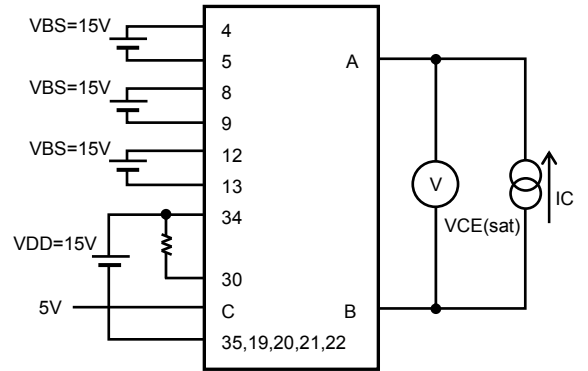

Figure 26. Test circuit for  $V_{CE(SAT)}$

■  $V_F$  (Test by pulse)

	U+	V+	W+	U-	V-	W-
A	16	16	16	13	9	5
B	13	9	5	22	21	20

	U(DB)	V(DB)	W(DB)	PFC Diode	Anti-parallel Diode
A	12	8	4	16	1
B	34	34	34	1	19

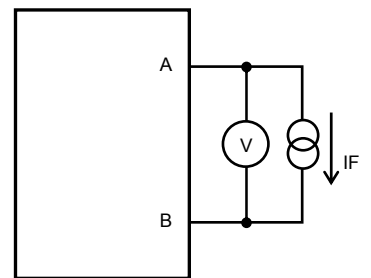

Figure 27. Test circuit for  $V_F$

■  $I_D$

	VBS U+	VBS V+	VBS W+	VDD
A	12	8	4	34
B	13	9	5	35

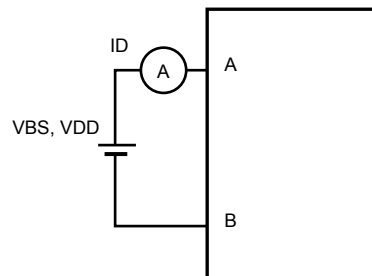

Figure 28. Test circuit for  $I_D$

# STK57FU394AG-E

## ■ VITRIP, VPTRIP

	VITRIP(U-)	VPTRIP
A	13	1
B	22	19
C	26	29
D	32	31

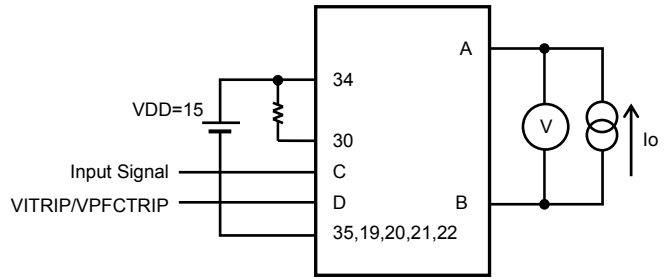
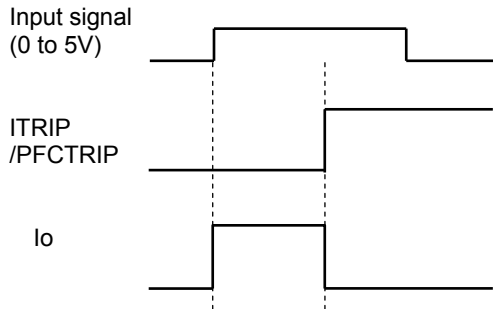

Figure 29. Test circuit for ITRIP.PTRIP

## ■ Switching time (The circuit is a representative example of the lower side U phase.)

	U+	V+	W+	U-	V-	W-	PFC IGBT
A	16	16	16	16	16	16	16
B	22	21	20	22	21	20	19
C	13	9	5	13	9	5	1
D	22	21	20	16	16	16	16
E	23	24	25	26	27	28	29

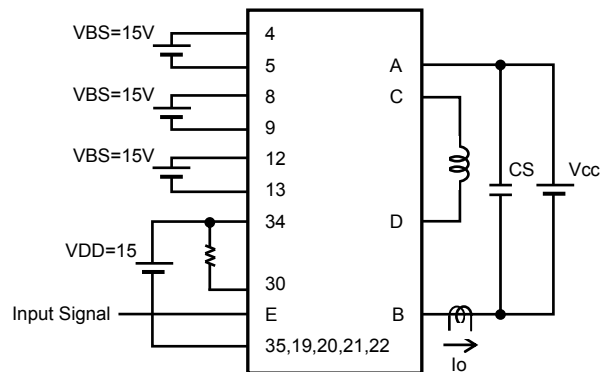
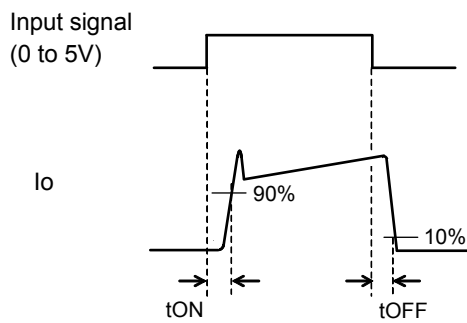

Figure 30. Test circuit for switching time

# STK57FU394AG-E

## Package Dimensions

unit : mm

SIP35 56x25.8 / SIP2A-3

CASE 127DY

ISSUE 0

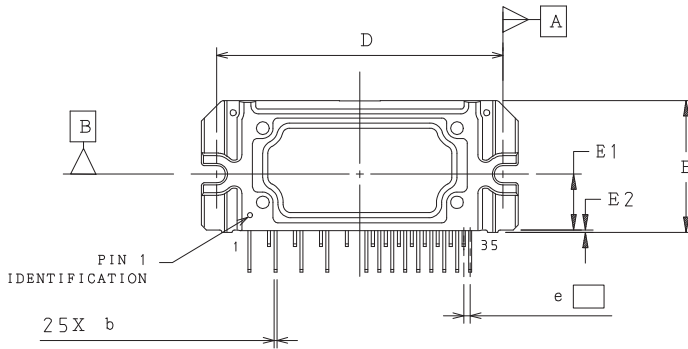

⊕	0.20	C	A	B
---	------	---	---	---

NOTE 3  
NOTE 4

TOP VIEW

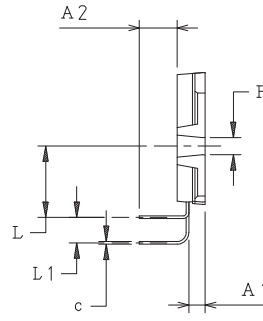

NOTE 3

END VIEW

DIM	MILLIMETERS		
	MIN.	NOM.	MAX.
A	5.00	5.50	6.00
A1	2.70	3.20	3.70
A2	6.90	7.40	7.90
A3	1.50	2.00	2.50
b	0.55	0.60	0.80
c	0.45	0.50	0.70
D	55.50	56.00	56.50
D1	61.50	62.00	62.50
D2	49.50	50.00	50.50
D3	45.70	46.20	46.70
E	25.30	25.80	26.30
E1	10.90 REF		
E2	0.00	0.50	1.00
e	1.27 BSC		
F	2.90	3.40	3.90
L	13.40	13.90	14.40
L1	4.50	5.00	5.50

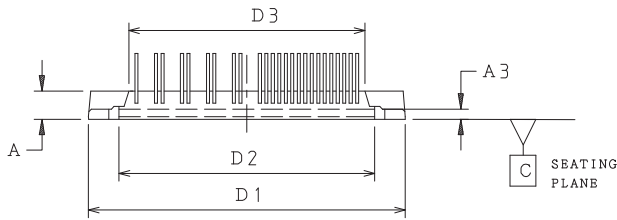

SIDE VIEW

NOTES:

1. DIMENSIONING AND TOLERANCING PER ASME Y14.5M, 2009.
2. CONTROLLING DIMENSION: MILLIMETERS
3. DIMENSIONS b AND c APPLY TO THE PLATED LEAD AND ARE MEASURED BETWEEN 1.00 AND 2.00 FROM THE LEAD TIP.
4. POSITION OF THE LEADS IS DETERMINED AT THE ROOT OF THE LEAD WHERE IT EXITS THE PACKAGE BODY.
5. MIRROR SURFACE MARK INDICATES PIN 1 POSITION.
6. MISSING PINS ARE: 2, 3, 6, 7, 10, 11, 14, 15, 17, AND 18.

ON Semiconductor and the ON Semiconductor logo are trademarks of Semiconductor Components Industries, LLC dba ON Semiconductor or its subsidiaries in the United States and/or other countries. ON Semiconductor owns the rights to a number of patents, trademarks, copyrights, trade secrets, and other intellectual property. A listing of ON Semiconductor's product/patent coverage may be accessed at [www.onsemi.com/site/pdf/Patent-Marking.pdf](http://www.onsemi.com/site/pdf/Patent-Marking.pdf). ON Semiconductor reserves the right to make changes without further notice to any products herein. ON Semiconductor makes no warranty, representation or guarantee regarding the suitability of its products for any particular purpose, nor does ON Semiconductor assume any liability arising out of the application or use of any product or circuit, and specifically disclaims any and all liability, including without limitation special, consequential or incidental damages. Buyer is responsible for its products and applications using ON Semiconductor products, including compliance with all laws, regulations and safety requirements or standards, regardless of any support or applications information provided by ON Semiconductor. "Typical" parameters which may be provided in ON Semiconductor data sheets and/or specifications can and do vary in different applications and actual performance may vary over time. All operating parameters, including "Typicals" must be validated for each customer application by customer's technical experts. ON Semiconductor does not convey any license under its patent rights nor the rights of others. ON Semiconductor products are not designed, intended, or authorized for use as a critical component in life support systems or any FDA Class 3 medical devices or medical devices with a same or similar classification in a foreign jurisdiction or any devices intended for implantation in the human body. Should Buyer purchase or use ON Semiconductor products for any such unintended or unauthorized application, Buyer shall indemnify and hold ON Semiconductor and its officers, employees, subsidiaries, affiliates, and distributors harmless against all claims, costs, damages, and expenses, and reasonable attorney fees arising out of, directly or indirectly, any claim of personal injury or death associated with such unintended or unauthorized use, even if such claim alleges that ON Semiconductor was negligent regarding the design or manufacture of the part. ON Semiconductor is an Equal Opportunity/Affirmative Action Employer. This literature is subject to all applicable copyright laws and is not for resale in any manner.

## Looking for pricing, stock, or lifecycle information?

Click below to explore more details on WIN SOURCE:

 [View STK57FU394AG-E on WIN SOURCE](#)

 [ON Semiconductor](#) Information

## Optimize Your Supply Chain with WIN SOURCE Solutions

-  Global Sourcing Solution
-  Obsolete Management
-  Cost Control Management
-  Shortage Management
-  Alternative Solution
-  Excess Inventory Management